

---

---

**S-57 APPENDIX B.1**  
*Annex A - Use of the Object Catalogue for ENC*

This document must only be used with Edition 2.0 of the  
ENC Product Specification - S-57 Appendix B.1

EDITION 4.0.0 – FEBRUARY 2014

© Copyright International Hydrographic Organization 2014

This work is copyright. Apart from any use permitted in accordance with the Berne Convention for the Protection of Literary and Artistic Works (1886), and except in the circumstances described below, no part may be translated, reproduced by any process, adapted, communicated or commercially exploited without prior written permission from the International Hydrographic Bureau (IHB). Copyright in some of the material in this publication may be owned by another party and permission for the translation and/or reproduction of that material must be obtained from the owner.

This document or partial material from this document may be translated, reproduced or distributed for general information, on no more than a cost recovery basis. Copies may not be sold or distributed for profit or gain without prior written agreement of the IHB and any other copyright holders.

In the event that this document or partial material from this document is reproduced, translated or distributed under the terms described above, the following statements are to be included:

*“Material from IHO publication [reference to extract: Title, Edition] is reproduced with the permission of the International Hydrographic Bureau (IHB) (Permission No ...../...) acting for the International Hydrographic Organization (IHO), which does not accept responsibility for the correctness of the material as reproduced: in case of doubt, the IHO’s authentic text shall prevail. The incorporation of material sourced from IHO shall not be construed as constituting an endorsement by IHO of this product.”*

*“This [document/publication] is a translation of IHO [document/publication] [name]. The IHO has not checked this translation and therefore takes no responsibility for its accuracy. In case of doubt the source version of [name] in [language] should be consulted.”*

The IHO Logo or other identifiers shall not be used in any derived product without prior written permission from the IHB.

## CONTENTS

1	Introduction .....	1
1.1	General.....	1
1.1.1	References within S-57 to other IHO publications .....	2
1.2	Presentation of the document .....	2
1.3	Use of language .....	2
1.4	Maintenance.....	2
1.4.1	Clarification.....	3
1.4.2	Revision.....	3
1.4.3	New Edition .....	3
1.4.4	Version control .....	3
1.4.4.1	Clarification version control.....	3
1.4.4.2	Revision version control.....	3
1.4.4.3	New Edition version control .....	3
2	General rules.....	4
2.1	Cartographic framework.....	4
2.1.1	Horizontal datum .....	4
2.1.2	Vertical datum .....	4
2.1.3	Sounding datum .....	4
2.1.4	Units .....	5
2.1.5	Dates.....	5
2.1.5.1	Seasonal Objects.....	5
2.1.6	Times.....	5
2.1.7	Cells .....	5
2.1.8	Seamless ENC coverage.....	5
2.1.8.1	Feature Object Identifiers.....	6
2.1.8.2	180° Meridian of Longitude .....	6
2.2	Data quality description.....	6
2.2.1	Production information .....	6
2.2.2	Up-to-datedness information.....	6
2.2.3	Quality, reliability and accuracy of bathymetric data.....	6
2.2.3.1	Quality of bathymetric data .....	7
2.2.3.2	Survey reliability .....	8
2.2.3.3	Quality of sounding .....	8
2.2.3.4	Sounding accuracy.....	8
2.2.3.5	Technique of sounding measurement.....	8
2.2.4	Accuracy of non-bathymetric data .....	9
2.2.4.1	Quality of positions.....	9
2.2.4.2	Horizontal accuracy.....	9
2.2.4.3	Vertical accuracy.....	9
2.2.5	Source of data.....	9
2.2.5.1	Source of bathymetric data .....	9
2.2.5.2	Source of other data.....	9
2.2.6	Compilation scale.....	9
2.2.7	Use of the attribute SCAMIN.....	10
2.2.7.1	Sample SCAMIN policy.....	11
2.3	Textual information.....	19
2.4	Colours and colour patterns .....	20
2.5	Reference to other publications .....	21
2.6	Updating .....	21
2.6.1	Issuing Updates in advance.....	21
2.6.1.1	Advance notification of changes to traffic separation schemes.....	22
2.6.2	Guidelines for encoding Temporary and Preliminary ENC Updates.....	23
2.6.2.1	Introduction .....	23
2.6.2.2	Temporary (T) Notices to Mariners (see S-4 – B-633) .....	23
2.6.2.3	Preliminary (P) Notices to Mariners (see S-4 – B-634).....	25

2.7	Multiple objects and objects shown out of position on paper charts .....	28
2.8	Minimal depiction areas (see S-4 – B-404) .....	28
2.8.1	Wide blank areas .....	28
2.8.2	Simplified or minimal depiction areas .....	28
3	Time Varying Objects .....	30
3.1	Magnetic data (see S-4 – B-270) .....	30
3.1.1	Magnetic variation .....	30
3.1.2	Abnormal magnetic variation (see S-4 – B-274) .....	30
3.2	Tidal data (see S-4 – B-406) .....	30
3.2.1	Time series data .....	30
3.2.2	Prediction by harmonic methods .....	31
3.2.3	Prediction by non-harmonic methods .....	31
3.3	Tidal stream data (see S-4 – B-407) .....	31
3.3.1	Tidal stream (flood/ebb) (see S-4 – B-407.4) .....	31
3.3.2	Tidal stream time series .....	31
3.3.3	Prediction by harmonic methods .....	31
3.3.4	Prediction by non-harmonic methods .....	32
3.3.5	Tidal stream panels (see S-4 – B-407.3) .....	32
3.4	Current data (see S-4 – B-408) .....	32
4	Topography .....	33
4.1	Land area .....	33
4.2	Vertical measurements (see S-4 – B-302 and B-303) .....	33
4.2.1	Vertical datum .....	33
4.2.2	Heights and elevations .....	33
4.3	Control points (see S-4 – B-304 to B-306) .....	34
4.4	Distance marks (see S-4 – B-307) .....	34
4.5	Coastline .....	34
4.5.1	Natural coastline (see S-4 – B-312) .....	34
4.5.2	Artificial coastline (see S-4 – B-313; B-321 to B-322 and B-324) .....	35
4.6	Harbour installations .....	36
4.6.1	Harbour facilities (see S-4 – B-320 and B-321.5) .....	36
4.6.2	Berths (see S-4 – B-321, B-321.6-9 and B-410.1) .....	36
4.6.3	Harbour offices (see S-4 – B-325) .....	36
4.6.4	Checkpoints .....	36
4.6.5	Small craft facilities (see S-4 – B-320.2; B-321.8 and B-432.5) .....	37
4.6.6	Docks .....	37
4.6.6.1	Dry docks (see S-4 – B-326.1) .....	37
4.6.6.2	Floating docks (see S-4 – B-326.2) .....	37
4.6.6.3	Tidal and non-tidal basins (see S-4 – B-326.3 and B-326.4) .....	38
4.6.6.4	Gates (see S-4 – B-326.5 to B-326.7) .....	38
4.6.6.5	Locks .....	38
4.6.6.6	Gridirons (see S-4 – B-326.8) .....	39
4.6.7	Mooring / warping facilities and pontoons .....	39
4.6.7.1	Mooring / warping facilities (see S-4 – B-327) .....	39
4.6.7.2	Piles .....	39
4.6.7.3	Pontoons (see S-4 – B-324.3) .....	40
4.6.8	Hulks .....	40
4.6.9	Dockside buildings and structures .....	40
4.6.9.1	Transit sheds and warehouses (see S-4 – B-328.1) .....	40
4.6.9.2	Timber yards (see S-4 – B-328.2) .....	40
4.6.9.3	Cranes (see S-4 – B-328.3) .....	40
4.6.10	Works in progress and projected (see S-4 – B-329) .....	41
4.7	Natural features (see S-4 – B-350) .....	41
4.7.1	Natural sceneries .....	41
4.7.2	Height contours, spot heights (see S-4 – B-351) .....	41
4.7.3	Marsh (see S-4 – B-312.2) .....	42
4.7.4	Dunes, sand hills (see S-4 – B-312.3) .....	42

4.7.5	Cliffs (see S-4 – B-312.1)	42
4.7.6	Rivers (see S-4 – B-353)	42
4.7.7	Rapids, waterfalls (see S-4 – B-353.5)	43
4.7.7.1	Rapids	43
4.7.7.2	Waterfalls	43
4.7.8	Lakes (see S-4 – B-353.6)	43
4.7.9	Salt pans (see S-4 – B-353.7)	44
4.7.10	Glaciers (see S-4 – B-353.8)	44
4.7.11	Vegetation (see S-4 – B-312.4, B-352.4 and B-354)	44
4.7.12	Lava flow (see S-4 – B-355)	45
4.8	Artificial features	45
4.8.1	Canals (see S-4 – B-361)	45
4.8.2	Railways (see S-4 – B-362)	45
4.8.3	Tunnels (see S-4 – B-363.1)	45
4.8.4	Cuttings and embankments (see S-4 – B-363.2 and B-364.1)	46
4.8.5	Dams (see S-4 – B-364.2)	46
4.8.6	Flood barrages (see S-4 – B-326.7)	46
4.8.7	Dykes (see S-4 – B-313.1)	46
4.8.8	Roads and tracks (see S-4 – B-365)	47
4.8.9	Causeways (see S-4 – B-313.3)	47
4.8.10	Bridges (see S-4 – B-381)	47
4.8.11	Conveyors (see S-4 – B-382.3)	47
4.8.12	Airfields (see S-4 – B-366)	48
4.8.13	Production and storage areas (see S-4 – B-328.2, B-367 and B-374.6)	48
4.8.14	Built-up areas (see S-4 – B-370)	48
4.8.15	Buildings, landmarks, tanks, silos (see S-4 – B-370 to B-376 and B-378)	49
4.8.16	Fences and walls	52
4.8.17	Fortified structures (see S-4 – B-379)	52
4.8.18	Pylons and bridge supports (see S-4 – B-381)	53
4.8.19	Oil barriers (see S-4 – B-449.2)	53
4.8.20	Views and sketches, viewpoints	53
4.8.21	Signs and Notice boards	54
5	Depth	55
5.1	Sounding datum	55
5.2	Depth contours (see S-4 – B-411)	55
5.3	Soundings (see S-4 – B-412 and B-413.1)	55
5.4	Depth areas	57
5.4.1	Geo object depth areas	57
5.4.2	Geometry of depth areas	57
5.4.3	Use of attributes DRVAL1 and DRVAL2 for depth areas in general	57
5.4.4	Not currently used	59
5.4.5	Not currently used	59
5.4.6	Not currently used	59
5.4.7	Not currently used	59
5.4.8	Rivers, canals, lakes, basins	59
5.5	Dredged areas (see S-4 – B-414)	59
5.6	Swept areas (see S-4 – B-415)	60
5.7	Areas of continual change (see S-4 – B-416)	61
5.8	Areas with inadequate depth information (see S-4 – B-417 and B-418)	61
5.8.1	Unsurveyed areas	61
5.8.1.1	Satellite imagery as source information (see S-4 – B-424.7)	61
5.8.2	Incompletely surveyed areas	61
5.8.3	Bathymetry in areas of minimal depiction of detail on paper charts	61
5.8.3.1	Areas of omitted bathymetry	62
5.8.3.2	Areas of very simplified bathymetry	62
5.8.4	Depth discontinuities between surveys (see S-4 – B-416.1)	62
6	Dangers	63

6.1	Rocks and coral reefs (see S-4 – B-421)	63
6.1.1	Rocks which do not cover (islets)	63
6.1.2	Rocks which may cover	63
6.2	Wrecks, foul ground and obstructions (see S-4 – B-422)	64
6.2.1	Wrecks	64
6.2.2	Obstructions, foul areas and foul ground	66
6.3	Danger lines	67
6.3.1	Danger line around a point danger or an isolated sounding	67
6.3.2	Danger line limiting an area of wrecks or obstructions	67
6.3.3	Danger line bordering an area through which navigation is not safe (see S-4 – B-420.1)	67
6.4	Overfalls, races, breakers, eddies (see S-4 – B-423)	68
6.5	Doubtful dangers (see S-4 – B-424)	68
6.6	Caution areas	68
7	Nature of the seabed	70
7.1	Description of the bottom (see S-4 – B-425 to B-427)	70
7.2	Special bottom types	71
7.2.1	Sandwaves (see S-4 – B-428.1)	71
7.2.2	Weed - Kelp (see S-4 – B-428.2)	71
7.2.3	Springs in the seabed (see S-4 – B-428.3)	71
7.2.4	Tideways (see S-4 – B-413.3)	71
8	Sea areas (see S-4 – B-550)	72
9	Harbour regulations	73
9.1	Regulations within harbour limits	73
9.1.1	Administrative harbour areas (see S-4 – B-430.1)	73
9.1.2	Speed limits (see S-4 – B-430.2)	73
9.2	Anchorage and prohibited/restricted anchorages; moorings	73
9.2.1	Anchorage (see S-4 – B-431.1; B-431.3 and B-431.7)	73
9.2.2	Anchor berths (see S-4 – B-431.2)	74
9.2.3	Anchoring restricted (see S-4 – B-431.4)	74
9.2.4	Mooring buoys (see S-4 – B-431.5)	74
9.2.5	Mooring trots (see S-4 – B-431.6)	74
9.2.6	Anchorage - relationships	75
10	Recommended tracks and routes	76
10.1	Leading, clearing and transit lines and recommended tracks (see S-4 – B-433 and B-434)	76
10.1.1	Navigation lines and recommended tracks	76
10.1.2	Range systems - relationship	77
10.1.3	Measured distances (see S-4 – B-458)	78
10.2	Routing measures	78
10.2.1	Traffic separation schemes	78
10.2.1.1	Traffic separation scheme lanes (see S-4 – B-435.1)	78
10.2.1.2	Traffic separation scheme boundaries (see S-4 – B-435.1)	79
10.2.1.3	Traffic separation lines (see S-4 – B-435.1)	79
10.2.1.4	Traffic separation zones (see S-4 – B-435.1)	79
10.2.1.5	Traffic separation scheme crossings (see S-4 – B-435.1)	79
10.2.1.6	Traffic separation scheme roundabouts (see S-4 – B-435.1)	79
10.2.1.7	Inshore traffic zones (see S-4 – B-435.1)	80
10.2.1.8	Precautionary areas (see S-4 – B-435.2)	80
10.2.2	Deep water routes (see S-4 – B-435.3)	80
10.2.2.1	Deep water route parts	80
10.2.2.2	Deep water route centrelines	81
10.2.3	Traffic separation scheme systems	81
10.2.4	Recommended routes (see S-4 – B-435.4)	81
10.2.5	Recommended direction of traffic flow (see S-4 – B-435.5)	82
10.2.6	Two-way routes (see S-4 – B-435.6)	82
10.2.7	Areas to be avoided (see S-4 – B-435.7)	83
10.3	Ferries (see S-4 – B-438)	83
10.4	Fairways (see S-4 – B-432.1 and B-434.5)	83

10.5 Archipelagic Sea Lane .....	83
10.5.1 Archipelagic Sea Lanes (see S-4 – B-435.10).....	83
10.5.2 Archipelagic Sea Lane Axis (see S-4 – B-435.10).....	84
10.5.3 Archipelagic Sea Lane systems.....	84
11 Regulated areas.....	85
11.1 Restricted areas in general (see S-4 – B-439.2 to B-439.4).....	85
11.2 Maritime jurisdiction areas (see S-4 – B-440).....	85
11.2.1 National territories.....	86
11.2.2 Custom zones.....	86
11.2.3 Free port areas.....	86
11.2.4 Territorial Seas.....	86
11.2.5 Contiguous Zones.....	87
11.2.6 Fishery zones.....	87
11.2.7 Continental Shelves.....	87
11.2.8 Exclusive Economic Zones.....	87
11.3 Military practice areas; submarine transit lanes; minefields.....	87
11.3.1 Military practice areas (see S-4 – B-441).....	87
11.3.2 Submarine transit lanes (see S-4 – B-441.5).....	87
11.3.3 Minefields (see S-4 – B-441.8).....	87
11.4 Dumping grounds (see S-4 – B-442 and B-446).....	88
11.5 Cables and cable areas.....	88
11.5.1 Submarine cables (see S-4 – B-443).....	88
11.5.2 Overhead cables (see S-4 – B-382).....	88
11.5.3 Submarine cable areas (see S-4 – B-443.3).....	88
11.6 Pipelines and pipeline areas.....	89
11.6.1 Pipelines, submarine or on land (see S-4 – B-377 and B-444).....	89
11.6.2 Diffusers, cribs.....	89
11.6.3 Overhead pipelines (see S-4 – B-383).....	89
11.6.4 Pipeline areas (see S-4 – B-444.3).....	90
11.7 Oil and Gas fields (see S-4 – B-445).....	90
11.7.1 Wellheads (see S-4 – B-445.1).....	90
11.7.2 Offshore platforms (see S-4 – B-445.2; B-445.4 and B-445.5).....	90
11.7.3 Offshore safety zones (see S-4 – B-445.6).....	90
11.7.4 Offshore production areas (see S-4 – B-445.3; B-445.9; B-445.11 and B-445.12).....	90
11.7.5 Offshore tanker loading systems (see S-4 – B-445.4).....	91
11.7.6 Flare stacks (see S-4 – B-445.2).....	91
11.8 Spoil grounds, dredging areas (see S-4 – B-446).....	91
11.9 Fishing equipment and aquaculture areas.....	91
11.9.1 Fishing facilities (see S-4 – B-447.1 to B-447.3).....	91
11.9.2 Marine farms (see S-4 – B-447.4 and B-447.6).....	92
11.9.3 Fish havens (see S-4 – B-447.5).....	92
11.9.4 Fishing grounds.....	92
11.10 Degaussing ranges (see S-4 – B-448).....	92
11.11 Historic wrecks (see S-4 – B-422).....	92
11.12 Seaplane landing areas (see S-4 – B-449.6).....	92
11.13 Various maritime areas.....	93
11.13.1 Ice areas (see S-4 – B-353.8 and B-449.1).....	93
11.13.2 Log ponds (see S-4 – B-449.2).....	93
11.13.3 Incineration areas (see S-4 – B-449.3).....	93
11.13.4 Cargo transshipment areas (see S-4 – B-449.4).....	93
11.13.5 Collision regulations.....	93
11.14 Nature reserves (see S-4 – B-437.3).....	93
11.15 Environmentally Sensitive Sea Areas (see S-4 – B-437).....	93
12 Aids to navigation.....	95
12.1 Lighthouses, navigational marks - relationships.....	95
12.1.1 Geo objects forming parts of navigational aids.....	95
12.1.2 Relationships.....	95

12.2 Buoyage systems and direction of buoyage (see S-4 – B-461)	96
12.3 Fixed structures (see S-4 – B-455)	98
12.3.1 Beacons	98
12.3.2 Lighthouses (see S-4 – B-457.3)	99
12.3.3 Daymarks	99
12.4 Floating structures (see S-4 – B-460)	100
12.4.1 Buoys	100
12.4.1.1 Emergency wreck marking buoys (see S-4 – B-461.3)	101
12.4.2 Light floats and light vessels (see S-4 – B-462.8)	101
12.5 Fog signals (see S-4 – B-451 to B-454)	101
12.6 Topmarks (see S-4 – B-463)	102
12.7 Retroreflectors (see S-4 – B-460.7)	102
12.8 Lights (see S-4 – B-470)	102
12.8.1 Description of lights	102
12.8.2 Types and functions of lights (see S-4 – B-471.1)	103
12.8.3 Rhythms of lights (see S-4 – B-471.2)	103
12.8.4 Elevations of lights (see S-4 – B-471.6)	103
12.8.5 Times of exhibition and exhibition conditions (see S-4 – B-473)	103
12.8.5.1 Night lights	103
12.8.5.2 Unwatched lights (see S-4 – B-473.1)	104
12.8.5.3 Occasional lights (see S-4 – B-473.2)	104
12.8.5.4 Daytime lights (see S-4 – B-473.4)	104
12.8.5.5 Fog lights (see S-4 – B-473.5)	104
12.8.6 Sector lights and lights not visible all round (see S-4 – B-475)	104
12.8.6.1 Sector lights (see S-4 – B-475.1)	104
12.8.6.2 Lights obscured by obstructions (see S-4 – B-475.3)	105
12.8.6.3 White fairway sectors (see S-4 – B-475.5)	105
12.8.6.4 Leading lights (see S-4 – B-475.6)	105
12.8.6.5 Directional lights (see S-4 – B-475.7)	106
12.8.6.6 Moiré effect lights (see S-4 – B-475.8)	106
12.8.7 Various special types of lights	106
12.8.8 Light structures	107
12.9 Radio stations (see S-4 – B-480 to B-484)	107
12.9.1 Marine and aero-marine radiobeacons (see S-4 – B-481)	108
12.9.2 Aeronautical radiobeacons (see S-4 – B-482)	108
12.9.3 Radio direction-finding stations (see S-4 – B-483)	108
12.9.4 Coast radio stations providing QTG service (see S-4 – B-484)	108
12.10 Radar beacons (see S-4 – B-486)	108
12.11 Radar surveillance systems (see S-4 – B-487)	109
12.11.1 Radar ranges (see S-4 – B-487.1)	109
12.11.2 Radar reference lines (see S-4 – B-487.2)	109
12.11.3 Radar station (see S-4 – B-487.3)	109
12.12 Radar conspicuous objects (see S-4 – B-485.2)	109
12.13 Radio reporting (calling-in) points (see S-4 – B-488)	110
12.14 Automatic Identification Systems (AIS)	110
12.14.1 AIS equipped aids to navigation (see S-4 – B-489)	110
12.14.1.1 Virtual AIS aids to navigation (see S-4 – B-489.2)	111
13 Marine services and signal stations	113
13.1 Pilot stations (see S-4 – B-491)	113
13.1.1 Pilot stations ashore (see S-4 – B-491.3 and B-491.4)	113
13.1.2 Pilot boarding places (see S-4 – B-491.1 and B-491.2)	113
13.2 Coastguard stations (see S-4 – B-492)	113
13.3 Rescue stations (see S-4 – B-493)	113
13.4 Signal stations (see S-4 – B-494 to B-497)	114
14 Geographic names	115
15 Collection objects	116
16 New Object	118



17 Masking..... 119

## Figures

<i>Figure 1 - Heights and elevations.....</i>	<i>34</i>
<i>Figure 2 - Shoreline constructions.....</i>	<i>35</i>
<i>Figure 3 - Landmarks.....</i>	<i>52</i>
<i>Figure 4 - Depth contours.....</i>	<i>55</i>
<i>Figure 5 - Geometry of depth areas.....</i>	<i>57</i>
<i>Figure 6 - Depth areas.....</i>	<i>58</i>
<i>Figure 7 - Area of wrecks.....</i>	<i>67</i>
<i>Figure 8 - Seabed areas.....</i>	<i>70</i>
<i>Figure 9 - Mooring trot.....</i>	<i>74</i>
<i>Figure 10 - Navigation lines and recommended tracks.....</i>	<i>77</i>
<i>Figure 11 - Range systems.....</i>	<i>77</i>
<i>Figure 12 - Junction.....</i>	<i>78</i>
<i>Figure 13 - One way traffic flow in two-way route.....</i>	<i>82</i>
<i>Figure 14 - Maritime jurisdiction areas.....</i>	<i>85</i>
<i>Figure 15 - Navigational aids.....</i>	<i>95</i>
<i>Figure 16 - Buoyage system and direction.....</i>	<i>98</i>
<i>Figure 17 - Obscured light sectors.....</i>	<i>105</i>
<i>Figure 18 - Overwriting symbols - example.....</i>	<i>119</i>
<i>Figure 19 - Area object crossing ENC cell boundaries.....</i>	<i>119</i>
<i>Figure 20 - Area objects extending beyond the entire limit of data coverage.....</i>	<i>119</i>
<i>Figure 21 - Area object with edges coincident with the coastline.....</i>	<i>121</i>
<i>Figure 22 - Area object with pattern fill.....</i>	<i>121</i>
<i>Figure 23 - "Linear" maritime jurisdiction area.....</i>	<i>121</i>
<i>Figure 24 - Traffic Separation Scheme with appropriate masking.....</i>	<i>122</i>
<i>Figure 25 - Traffic Separation Scheme with masked CTNARE.....</i>	<i>123</i>

## Document Control

Version	Version Type	Date	Approved By	Signed Off By	Role
3.0.0	New version incorporating all IHO approved new encoding guidance since publication of Edition 2.1 (April 2002).	Oct 2011	TSMAD	B. Greenslade	TSMAD Chair
3.1.0	Revision incorporating IHO approved new encoding guidance.	Oct 2012	TSMAD	B. Greenslade	TSMAD Chair
4.0.0	New version incorporating new and revised IHO encoding guidance and new specification for encoding Virtual AIS Aids to Navigation.	Feb 2014	TSMAD	B. Greenslade	TSMAD Chair

Page intentionally left blank

# 1 Introduction

## 1.1 General

The following clauses specify the conventions that must be used to encode the geometry and semantic description of each object in an ENC. This document is laid out, as far as possible, along the lines of the IHO publication "Regulations of the IHO for International (INT) Charts and Chart Specifications of the IHO – S-4".

This document describes how to encode information that the cartographer considers relevant to an ENC. The content of an ENC is at the discretion of the Producing Authority provided that the conventions described within this document are followed. A "Producing Authority" is a Hydrographic Office (HO) or an organisation authorised by a government, HO or other relevant government institution to produce ENCs.

This document is intended for use with Edition 2.0 of the ENC Product Specification (S-57 Appendix B1, Annex A) contained within S-57 Edition 3.1 which was issued in November 2000, including S-57 Supplement No. 2 (June 2009).

Although this document is open to change the following guidelines must be adhered to:

- **Any change to this document must not cause existing published ENCs to be changed retrospectively. However producers are encouraged to include new changes (if the data is affected by them) in any new ENCs and any ENC for which there is a planned New Edition. Any required change to data due to a significant issue affecting safety of navigation will be addressed by a communication to all producers by the IHB.**
- **Any change to this document must not cause a subsequent issue to the use of the data in ECDIS.**

Further principles and guidance related to the planning, design, production, maintenance, distribution and display of ENCs, ENC portfolios and ECDIS can be found in the following documents:

- IHO M-3 – Resolutions of the IHO; Resolution 1/1997 (as amended), Principles of the Worldwide Electronic Navigational Chart Database (WEND);
- IHO S-4 – Regulations of the IHO for International (INT) Charts and Chart Specifications of the IHO. Note that applicable S-4 references are supplied with clause headings throughout this document;
- IHO S-52 – Specifications for Chart Content and Display Aspects of ECDIS;
- IHO S-62 – ENC Producer Codes;
- IHO S-63 – IHO Data Protection Scheme;
- IHO S-65 – Electronic Navigation Charts (ENC) "Production, Maintenance and Distribution Guidance";
- IHO S-66 – Facts About Electronic Charts and Carriage Requirements;
- IMO Resolution A.817 (19), as amended by MSC.64 (67) and MSC.86 (70) – Performance Standards for Electronic Chart Display and Information Systems (ECDIS).

In addition, the following document has been derived from the IHO S-57 Standard, including to a large part this document:

- IHO S-58 - Recommended ENC Validation Checks.

**NOTE:** Clause 3.5.7 of the ENC Product Specification provides guidance on the encoding of the attribute INFORM to describe the meaning for attribute values which appear for the first time in S-57 Edition 3.1, for reasons of backward compatibility with S-57 Edition 3.0. Similarly, clauses 3.3.1, 3.5.2.1 and 3.5.7.1 in section 4 of S-57 Edition 3.1 Supplement No. 2 (June 2009) provide guidance on the encoding of the attribute INFORM to describe the meaning for objects and attribute values which appeared for the first time in S-57 Edition 3.1 Supplement No. 1 (January 2007).

Edition 3.4 (January 2008) of the IHO Presentation Library (S-52 Appendix 2, Edition 4.3 – IHO Colour and Symbol Specifications for ECDIS, Annex A) no longer requires the encoding of INFORM where these objects and attribute values are populated.

Encoders are advised that it is no longer required to populate INFORM on feature objects to describe the meaning of new objects and attribute values appearing for the first time in S-57 Edition 3.1 or Supplement No. 1.

For existing ENC cells, ECDIS display will not be affected by the retention of populated values for INFORM.

### 1.1.1 References within S-57 to other IHO publications

Throughout S-57 documentation, there are references to clauses in other IHO publications, notably S-4 – Regulations of the IHO for International (INT) Charts and Chart Specifications of the IHO; and INT1 – Symbols, Terms and Abbreviations used on Charts. S-57 has effectively been “frozen” since 2000, but these publications have been revised, and as such clause references quoted in S-57 documents may be incorrect. Note that S-4 and INT1 references quoted in this document are correct for the versions of those publications current at the time of publication.

Encoders should also note that IHO Hydrographic Dictionary, Edition 5 index numbers as quoted in S-57 Chapters 1 and 2 (Objects and Attributes) may refer to definitions that have been revised or superseded. Encoders should therefore use the on-line IHO Hydrographic Dictionary, which can be found on the IHO web site.

## 1.2 Presentation of the document

The following conventions are used:

- Presentation conventions:
 

Object class:	<b>WRECKS</b>
Geometric primitive:	(P,A)*
Attribute:	EXPSOU
Mandatory attribute:	<u>WATLEV</u>
Prohibited attribute:	<del>VERDAT</del>
Attribute value:	-2.4
- Attributes\_A: For each object class, the whole list of subset A is given, with the specific applicable attribute values, where required, for the feature object. Reference should be made to S-57 Appendix B1; ENC Product Specification, section 3.5.2, for conditional mandatory attributes.
- Attributes\_B, attributes\_C: Except for attributes INFORM, NINFOM, and more rarely SORDAT, the attributes from subsets B and C are not mentioned in the following lists; however, this does not mean that their use is prohibited.

For definitions of attribute subsets A, B and C, see S-57 Appendix A, Chapter 1, section 1.1.

\* For geometric primitives: P = point; L = line; A = area; N = none.

## 1.3 Use of language

Within this document:

- “Must” indicates a mandatory requirement.
- “Should” indicates an optional requirement, that is the recommended process to be followed, but is not mandatory.
- “May” means “allowed to” or “could possibly”, and is not mandatory.

## 1.4 Maintenance

Changes to this document are coordinated by Transfer Standards Maintenance and Applications Development Working Group (TSMAD). Individuals that wish to make changes to the document must address their comments to the TSMAD.

There are three change proposal types to the Use of the Object Catalogue for ENC. They are:

- (1) Clarification;
- (2) Revision; and

### (3) New Edition.

Any change proposal must be one of these types. Note that as S-57 has been “frozen” (with the exception of this document), all changes to this document must relate only to encoding guidance for the compilation of IHO compliant ENCs, and must not change or be contrary to the rules and conventions described in all other S-57 documentation, including clarifications included in the S-57 Maintenance Document (S-57 MD8).

**ALL** proposed changes must be technically assessed before approval. Any revisions or significant changes to be introduced through a New Edition will normally be first published on the IHO web site ([www.iho.int](http://www.iho.int)) as ENC Encoding Bulletins and/or Frequently Asked Questions on the TSMAD page, and if considered an issue that is essential for safe navigation will also be promulgated as an IHO Circular Letter.

Approved changes must be issued and entered on the Document Control page of this document.

#### **1.4.1 Clarification**

Clarifications are non-substantive changes to the document. Typically, clarifications: remove ambiguity; correct grammatical and spelling errors; amend or update cross references; and insert improved graphics. A clarification must not cause any substantive semantic change to the document.

#### **1.4.2 Revision**

Revisions are defined as substantive semantic changes to the document. Typically, revisions will change the document to correct factual errors; or introduce necessary changes to ENC encoding guidance that has become evident as a result of practical experience or changing circumstances. A revision must not also be classified as a clarification. Revisions could have an impact on either existing users or future users of the document. All cumulative clarifications must be included with the release of approved revisions.

#### **1.4.3 New Edition**

New Editions are significant changes to the encoding guidance in the document, noting that such changes must not change or be contrary to the rules and conventions described in all other S-57 documentation. They can include additional information from the TSMAD or related committees that were not originally included in the document. New Editions result in a new major version of the document. One New Edition may result in multiple related actions. All cumulative clarifications and revisions must be included with the release of an approved New Edition. After approval the New Edition will be available for use at a date specified by the TSMAD.

#### **1.4.4 Version control**

The TSMAD must release new versions of the document as necessary. New versions must include clarifications, corrections and extensions. Each version must contain a change list that identifies the changes between versions of the document.

##### **1.4.4.1 Clarification version control**

Clarifications must be denoted as 0.0.x. Each clarification or set of clarifications approved at a single point in time must increment x by 1.

##### **1.4.4.2 Revision version control**

Revisions must be denoted as 0.x.0. Each revision or set of revisions approved at a single point in time must increment x by 1. Revision version control will set clarification version control to 0.

##### **1.4.4.3 New Edition version control**

New Editions must be denoted as x.0.0. Each New Edition approved at a single point in time must increment x by 1. New Edition version control will set the clarification and revision version control to 0.

## 2 General rules

### 2.1 Cartographic framework

#### 2.1.1 Horizontal datum

The horizontal datum must be unique in a data set and must be WGS 84. It must be encoded in the "Horizontal Geodetic Datum" [HDAT] subfield of the "Data Set Parameter" [DSPM] field.

The use of the meta object **M\_HDAT** is prohibited.

The use of the attribute HORDAT on any spatial object is prohibited.

The meta object **M\_HOPA** may be used to provide the shift from another horizontal datum to WGS 84 (see S-57 Appendix B.1 – ENC Product Specification clause 4.1). This meta object supports the manual input in ECDIS of other information such as local Notices to Mariners which may be provided on a horizontal datum other than WGS84.

Meta object: Horizontal datum (**M\_HOPA**) (A)  
 Attributes: HORDAT - contains the original horizontal datum of the data.  
SHIPAM INFORM NINFOM

Where data has been transformed to WGS 84 from another datum, the Producing Authority may wish to indicate the accuracy of the transformation. If so, it must be done using the attribute INFORM on the meta object **M\_QUAL**.

#### 2.1.2 Vertical datum

Vertical datum information is encoded using the subfield VDAT, the meta object **M\_VDAT**, or the attribute VERDAT on individual objects. The values encoded in the attributes ELEVAT, HEIGHT, VERCCL, VERCLR, VERCOP and VERCOSA are referenced to the specified datum(s). VERDAT must not be encoded on an object unless at least one of the above attributes is also encoded on that object.

The default value for the entire data set must be given in the "Vertical Datum" [VDAT] subfield of the "Data Set Parameter" [DSPM] field.

If the vertical datum for an area is different to the value given in the VDAT subfield for the data set, it must be encoded using **M\_VDAT**. The areas covered by these meta objects must not overlap.

Meta object: Vertical datum (**M\_VDAT**) (A)  
 Attributes: VERDAT INFORM NINFOM

Height contours, going across areas having different values of vertical datum, must be split at the border of these areas.

Various datums are used on paper charts and these datums are used in the same way for ENC. For example, different datums may be used for the following:

- altitude of spot heights, height contours, landmarks;
- elevation of lights;
- vertical clearance.

Where different vertical datums are used for the various vertical measurements, the default value given by the VDAT subfield or **M\_VDAT** applies to the first group of the above list. The attribute VERDAT on an individual object applies to the elevation of lights and vertical clearances and must only be populated if different to the value given by VDAT or **M\_VDAT**.

#### 2.1.3 Sounding datum

Sounding datum information is encoded using the subfield SDAT or the meta object **M\_SDAT**, and must be constant over large areas. The values encoded in the attributes VALSOU, DRVAL1,



DRVAL2 and VALDCO, and the sounding values encoded in **SOUNDG** objects, are referenced to this datum.

The default value for the entire data set must be given in the “Sounding Datum” [SDAT] subfield of the “Data Set Parameter” [DSPM] field.

If the sounding datum for an area is different to the value given in the SDAT subfield for the data set, it must be encoded using **M\_SDAT**. The areas covered by these meta objects must not overlap.

Meta object: Sounding datum (**M\_SDAT**) (A)  
Attributes: VERDAT INFORM NINFOM

The use of the attribute VERDAT on individual objects related to depth (e.g. **DEPARE**, **DEPCNT**, **DRGARE**, **OBSTRN**, **SOUNDG**, **UWTROC**, **WRECKS**) is prohibited.

Depth contours and depth areas going across areas having different values of sounding datum must be split at the border of those areas.

#### 2.1.4 Units

The depth, height and positional accuracy units in a data set must be metres. They must be given in the “Units of Depth Measurement” [DUNI], “Units of Height Measurement” [HUNI] and “Units of Positional Accuracy” [PUNI] subfields of the “Data Set Parameter” [DSPM] field.

The use of the meta object **M\_UNIT** is prohibited.

#### 2.1.5 Dates

When encoding dates using the attributes CDATE, DATEND, DATSTA, PEREND, PERSTA, SORDAT, SUREND and SURSTA, and no specific year, month or day is required, the following values must apply in conformance to ISO 8601:1988.

- No specific year required, same day each year: --MMDD
- No specific year required, same month each year: --MM
- No specific day required: CCYYMM
- No specific month required: CCYY

Notes: CCYY = calendar year; MM = month; DD = day.  
In the first two values, the dashes (--) must be included.

##### 2.1.5.1 Seasonal Objects

If it is required to show seasonality of objects, it must be done using the attribute STATUS = 5 (periodic/intermittent). If it is required to encode the start and/or end dates of the season, this must be done using the attributes PERSTA and PEREND.

#### 2.1.6 Times

If it is required to show the beginning and end of the active period of tidal objects, it must be encoded using the attributes TIMSTA and TIMEND. When using these attributes, all times must be encoded as Coordinated Universal Time (UTC). The attribute definition for TIMSTA and TIMEND (see S-57 Appendix A, Chapter 2 – Attributes) states that the mandatory format is CCYYMMDDThhmmss, where T is the separator, and this format must be used.

#### 2.1.7 Cells

Latitude and longitude coordinates (stored in decimal degrees) should be held in ENC production systems at a resolution of 0.0000001 ( $10^{-7}$ ). Therefore the Coordinate Multiplication Factor (COMF) subfield value in the Data Set Parameter (DSPM) field should be set to 10000000 ( $10^7$ ) for all cells.

#### 2.1.8 Seamless ENC coverage

There must be no gaps in data between adjoining cells of the same Navigational Purpose. Similarly, there must be no overlapping data between cells of the same Navigational Purpose (see S-57 S-57 Appendix B.1 - Annex A February 2014 Edition 4.0.0

Appendix B.1 – ENC Product Specification, clause 2.2), except at the agreed adjoining national data limits, where, if it is difficult to achieve a perfect join, a 5 metre overlapping buffer zone may be used.

To ensure a seamless ECDIS display of ENC data within a Navigational Purpose, it is important that the data on the cell border is aligned and matched with the corresponding data in any adjoining cells of the same Navigational Purpose where possible. Where there is a mismatch in depth data between adjoining cells, editing of the depth data should be done such that depth contours and depth areas are adjusted on the side of safety. Edge matching of data across different Navigational Purposes, particularly depth data, is often not possible due to generalisation issues resulting from differing compilation scales, although features such as maritime boundaries, navigation lines, recommended tracks, roads etc. should be edge matched where possible. Note that point or line feature objects which are at the border of coverage (**M\_COVR** with **CATCOV = 1**) of adjoining cells with the same Navigational Purpose must be part of only one cell.

In areas which include neighbouring producer nations, Hydrographic Offices should co-operate to agree on cell boundaries and ensure no data overlap within Navigational Purposes. Where possible, adjoining nations should agree on common data boundaries within a technical arrangement based on cartographic convenience and benefit to the mariner. Suitable communications between neighbouring nations should be put in place to ensure data consistency across cell boundaries. These should include exchange mechanisms to allow access to each other's ENCs.

#### **2.1.8.1 Feature Object Identifiers**

Clause 3.1 of S-57 Appendix B.1 – ENC Product Specification, provides guidance on the indication of unique world-wide identifiers for ENC feature objects through the population of the Feature Object Identifier (FOID) field. Incorporated in this guidance is advice that the FOID may be used to identify multiple instances of the same object, with examples listed of the same object appearing in different usage bands, or an object being split by the ENC cell structure.

Where a real-world feature has multiple parts within a single ENC cell due to the ENC cell structure, the FOID may be repeated for each part of the feature object in the cell. Where this occurs, all parts of the geo object in the cell must be identical, i.e. same object class and attribute values; and they must not be a component of a collection object or a master/slave relationship.

#### **2.1.8.2 180° Meridian of Longitude**

Clause 2.2 of S-57 Appendix B.1 – ENC Product Specification, describes the construct, including geographic extent, to be used for ENC cells. This clause does not address ENC cells that cross the 180° Meridian of Longitude. There is currently no production software or ECDIS system that can handle ENC cells that cross the 180° Meridian, therefore to avoid ECDIS load and display issues ENC cells must not span the 180° Meridian of Longitude.

## **2.2 Data quality description**

### **2.2.1 Production information**

The Producing Authority of the ENC must be given in the cell file name and in the "Producing Agency" [AGEN] subfield of the "Data Set Identification" [DSID] field. The use of the meta object **M\_PROD** is prohibited.

### **2.2.2 Up-to-datedness information**

Up-to-datedness information must be given in the cell file name extension and in the "Edition Number" [EDTN], "Update Number" [UPDN], "Update Application Date" [UADT] and "Issue Date" [ISDT] subfields of the "Data Set Identification" [DSID] field.

### **2.2.3 Quality, reliability and accuracy of bathymetric data**

Information about quality, reliability and accuracy of bathymetric data is given using:

- the meta object **M\_QUAL** for an assessment of the quality of bathymetric data,

- the meta object **M\_SREL** for additional information about the survey,
- the attributes QUASOU, SOUACC and TECSOU on groups of soundings or individual objects,
- the attributes POSACC and QUAPOS on the spatial objects (see clause 2.2.4.1).

For the mariner, **M\_QUAL** provides the most useful information. Therefore, the use of **M\_QUAL** is mandatory for areas containing depth data or bathymetry.

More detailed information about a survey may be given using **M\_SREL**. For example, in incompletely surveyed areas, lines of passage soundings may be indicated as such using a linear **M\_SREL** object. This information is more difficult for the mariner to interpret. Therefore, the use of **M\_SREL** is optional.

For individual objects (wrecks, obstructions etc), or small groups of soundings, QUASOU, SOUACC and TECSOU may be used to provide additional information about quality and accuracy.

### 2.2.3.1 Quality of bathymetric data

The meta object **M\_QUAL** defines areas within which uniform assessment exists for the quality of bathymetric data, and must be used to provide an assessment of the overall quality of bathymetric data to the mariner. Areas of a cell containing depth data or bathymetry must be covered by one or more **M\_QUAL**, which must not overlap.

Meta object: Quality of data (**M\_QUAL**) (A)  
 Attributes: ~~CATQUA~~ CATZOC DRVAL1  
 DRVAL2 - the maximum depth to which the quality information applies.  
 POSACC SOUACC SURSTA SUREND TECSOU ~~VERDAT~~ INFORM  
 NINFOM

Remarks:

- Wherever possible, meaningful and useful values of CATZOC should be used, i.e. values other than CATZOC = 6 (data not assessed), for areas of bathymetry. For areas of unstable seafloors, the attribute SUREND may be used to indicate the date of the survey of the underlying bathymetric data.
- A CATZOC category indicates that the depths encoded within a **M\_QUAL** area meet the minimum criteria described in the CATZOC definition table. A CATZOC category may be further sub-divided by specifying depth and positional accuracy, and sounding technique, using the attributes POSACC, SOUACC and TECSOU, within separate **M\_QUAL** areas.
- DRVAL1 must not be used on a **M\_QUAL** object, unless a swept area occupies the entire **M\_QUAL** area (see clause 5.6).
- DRVAL2 must not be used on a **M\_QUAL** object, except to specify the maximum depth to which the CATZOC category applies. When DRVAL2 is specified, the CATZOC category applies only to depths equal to or shoaler than DRVAL2. No quality information is provided for depths deeper than DRVAL2.
- POSACC must not be used on a **M\_QUAL** object, except to specify a higher positional accuracy of the depths than the CATZOC category indicates. When DRVAL1 is specified, POSACC must not be used - there is no positional accuracy information provided for any underlying depths in this circumstance.
- SOUACC must not be used on a **M\_QUAL** object, except to specify a higher accuracy of the depths than the CATZOC category indicates. When DRVAL1 is specified, SOUACC refers only to the accuracy of the swept depth defined by DRVAL1 - there is no depth accuracy information provided for any underlying depths in this circumstance.
- TECSOU must not be used on a **M\_QUAL** object to specify a lower quality than the CATZOC category indicates.
- When the **M\_QUAL** area contains soundings from multiple surveys of different techniques, the attribute TECSOU must not be used. TECSOU may be populated with multiple values only where the **M\_QUAL** area is covered by a survey or surveys that have used multiple common techniques, e.g. an area covered by multiple surveys all using a modern echosounder combined with a sonar or mechanical sweep system.
- When the **M\_QUAL** area contains data from only one survey, the date of survey, if required, must be specified using the attribute SUREND. When the **M\_QUAL** area contains data from two or

more surveys, the date of the oldest survey, if required, must be specified using the attribute SURSTA, and the date of the most recent survey, if required, must be specified using SUREND.

- Additional quality information may be given using the meta object **M\_SREL**.
- Where **M\_QUAL** areas are encoded over land, CATZOC should be set to 6 (unassessed).
- **M\_QUAL** may either be encoded over wet areas only, or alternatively a single **M\_QUAL** object may be created for the whole cell over wet and dry areas, but see 1<sup>st</sup> bullet point above.
- When **M\_QUAL** and the meta object **M\_ACCY** are encoded in a cell, they should not overlap.
- When both **M\_QUAL** and **M\_ACCY** objects are used in a cell, the area covered by these objects should equal the area of data coverage for the cell.
- POSACC on the **M\_QUAL** applies to bathymetric data situated within the area, while QUAPOS or POSACC on the associated spatial objects qualifies the location of the **M\_QUAL** object itself.
- As a result of some disasters, e.g. earthquakes, tsunamis, hurricanes, it is possible that large areas of seafloor have moved and/or become cluttered with dangerous obstructions. Emergency surveys may subsequently be conducted over essential shipping routes and inside harbours. Outside these surveys, all existing detail is now suspect, whatever the quality of the previous surveys. In such cases, the CATZOC value should be reclassified to value 5 (zone of confidence D) in the affected areas outside the area covered by emergency surveys.

### 2.2.3.2 Survey reliability

The survey reliability may be encoded using the meta object **M\_SREL**.

Meta object: Survey reliability (**M\_SREL**) (L,A)  
 Attributes: QUAPOS QUASOU SCVAL1 SCVAL2 SDISMN SDISMX SURATH  
 SUREND SURSTA SURTYP ~~TECSOU~~ INFORM NINFOM

Remarks:

- If the attributes SOUACC and TECSOU are required, they must be encoded on either the meta object **M\_QUAL** or on individual geo objects (e.g. **SOUNDG**).
- If it is required to encode information to indicate the source of a survey, it must be done using the attribute SURATH on **M\_SREL** (see clause 2.2.5.1).
- QUAPOS on the **M\_SREL** applies to bathymetric data situated within the area, while QUAPOS or POSACC on the associated spatial objects qualifies the location of the **M\_SREL** object itself.

### 2.2.3.3 Quality of sounding

If it is required to encode the quality of sounding, it must be done using the attribute QUASOU on either the meta object **M\_SREL** or on individual geo objects (e.g. **SOUNDG**).

The quality of sounding must not be encoded using QUASOU on the depth geo object, unless it is different to the value of QUASOU encoded on **M\_SREL** (see tables 5.1 and 6.4).

### 2.2.3.4 Sounding accuracy

Sounding accuracy is encoded using the attribute CATZOC on the meta object **M\_QUAL**. If it is required to encode additional sounding accuracy information (see clauses 2.2.3.1 and 5.6), it must be done using the attribute SOUACC on either the meta object **M\_QUAL** or on individual geo objects (e.g. **SOUNDG**).

The accuracy of sounding must not be encoded using SOUACC on the depth geo object, unless it is different to the value of SOUACC encoded on **M\_QUAL**.

### 2.2.3.5 Technique of sounding measurement

If it is required to encode the technique of sounding measurement, it must be done using the attribute TECSOU on either the meta object **M\_QUAL** or on individual geo objects (e.g. **SOUNDG**).

The technique of sounding measurement must not be encoded using TECSOU on the depth geo object, unless it is different to the value of TECSOU encoded on **M\_QUAL**.

## 2.2.4 Accuracy of non-bathymetric data

### 2.2.4.1 Quality of positions

The meta object **M\_ACCY** may be used to provide an overall accuracy of position for all non-bathymetric features. It must not be used to provide the accuracy of bathymetric information.

Meta object: Accuracy of data (**M\_ACCY**) (A)  
 Attributes: ~~HORACC~~ POSACC ~~SQUACC~~ ~~VERACC~~ INFORM NINFOM

The attributes QUAPOS and POSACC may be applied to any spatial object, in order to qualify the location of an object.

QUAPOS and POSACC must not be applied to the spatial object of any geo object if they are identical to the QUAPOS and POSACC values of the underlying meta object.

QUAPOS gives qualitative information, whereas POSACC gives quantitative information.

POSACC on the **M\_ACCY** applies to non bathymetric data situated within the area, while QUAPOS or POSACC on the associated spatial objects qualifies the location of the **M\_ACCY** object itself.

Meta objects **M\_ACCY** and **M\_QUAL** should not overlap.

### 2.2.4.2 Horizontal accuracy

If it is required to encode the accuracy of a horizontal clearance (attribute HORCLR), it must be done using the attribute HORACC.

HORACC applies only to HORCLR. There is no attribute to express the accuracy of the attributes HORLEN and HORWID.

### 2.2.4.3 Vertical accuracy

If it is required to encode the accuracy of a vertical clearance (attributes VERCLR, VERCOP, VERCSA, VERCCL), it must be done using the attribute VERACC.

If several vertical clearances are given for one object, the accuracy given must be that of the least accurate.

## 2.2.5 Source of data

### 2.2.5.1 Source of bathymetric data

Details of the source surveys used in compilation may be encoded using the meta object **M\_SREL**, as described in clause 2.2.3.2.

Remarks:

- If it is required to encode details of the survey authority, it must be done using the attribute SURATH, and must not be encoded using the attribute SORIND.
- If an object has a source different to that given by the underlying **M\_SREL**, this other source should be encoded using both the attributes SORIND and SORDAT on the object, but only if this information is considered to be useful to the mariner.

### 2.2.5.2 Source of other data

The source of non-bathymetric information should be encoded using both the attributes SORIND and SORDAT on the individual objects, but only if this information is considered to be useful to the mariner.

## 2.2.6 Compilation scale

The compilation scale should be considered as the optimum display scale of ENC data.

The default value for the entire data set must be given in the “Compilation Scale of Data” [CSCL] subfield of the “Data Set Parameter” [DSPM] field. The default value should be the compilation scale appropriate to the greater part of the data in the cell.

If the compilation scale for an area is different to the value given in the CSCL subfield for the data set, it must be encoded using the meta object **M\_CSCL**. The areas covered by these meta objects must not overlap.

Meta object:    Compilation scale of data (**M\_CSCL**)    (A)  
Attributes:    CSCALE    INFORM    NINFOM

It is recommended that the compilation scales for ENCs are based upon standard radar ranges:

Selectable Range	Standard scale (rounded)
200 NM	1:3000000
96 NM	1:1500000
48 NM	1:700000
24NM	1:350000
12 NM	1:180000
6 NM	1:90000
3 NM	1:45000
1.5 NM	1:22000
0.75 NM	1:12000
0.5 NM	1:8000
0.25 NM	1:4000

table 2.1

Normally, the nearest larger standard scale should be used, e.g. an ENC produced from a 1:25000 paper chart should have a compilation scale of 1:22000.

Exceptionally, if source material permits, the next larger scale may be used.

Where the source scale is larger than 1:4000 or smaller than 1:3000000 then the actual scale should be used.

Remarks:

- The compilation scale provides the reference value for the overscale indication on an ECDIS.
- The use of too many **M\_CSCL** objects within the same ENC cell should be avoided. The values for the attribute CSCALE of any **M\_CSCL** object should be populated using the same criteria as those used for setting the default compilation scale for the cell.
- Note that there are no maximum and minimum compilation scales defined for ENC cell Navigational Purposes (see S-57 Appendix B.1 – ENC Product Specification, clause 2.1).

### 2.2.7 Use of the attribute SCAMIN

The SCAMIN value of an object determines the display scale below which the object is no longer displayed. Its purpose is to reduce clutter, to prioritise the display of objects and to improve display speed. In encoding its value, the Producing Authority should consider these factors, as well as the scale at which the object is no longer likely to be required for navigation.

In order to optimise the performance and clarity of the ENC, it is strongly recommended that SCAMIN is used.

Remarks:

- SCAMIN only affects the display of an object on an ECDIS, not its presence in the SENC.
- If SCAMIN is not encoded, the object is displayed at all scales.

- Where SCAMIN is used, it must always be set to a scale less (i.e. to a smaller scale) than or equal to the compilation scale of the data as described in clause 2.2.6 above. Failure to follow this rule will mean that objects will not be displayed on screen until the overscale warning is activated.
- Group 1 and Meta objects must always be displayed. Therefore, SCAMIN must not be encoded on Group 1 and Meta objects.
- If the same object exists in cells of different Navigational Purposes, the same SCAMIN value should be assigned to each occurrence of the object.

### 2.2.7.1 Sample SCAMIN policy

The following policy for the application of SCAMIN to an ENC portfolio is based on the ENC cell compilation scales recommended in clause 2.2.6 (table 2.1). While the procedure described below to determine the SCAMIN value for feature objects in an ENC cell is recommended, the SCAMIN values used are at the discretion of the Producing Authority. Authority's should cooperate at the regional or RENC level to determine a SCAMIN policy that results in suitable and consistent display of ENC data for the mariner across and, where required between, regions.

SCAMIN values used should be selected from the following list:

19999999
9999999
4999999
2999999
1499999
999999
699999
499999
349999
259999
179999
119999
89999
59999
44999
29999
21999
17999
11999
7999
3999
1999
999

table 2.2 – SCAMIN values

- SCAMIN values for features within an ENC should be set to either 1, 2, 3 or 4 steps smaller scale than the compilation scale of the ENC.
- Table 2.3 lists the step values (i.e. 1, 2, 3 or 4) that may be applied for specific object classes together with any relevant conditions and additional flexibilities.

Following this process provides an automated approach to setting SCAMIN which takes account of the relative importance of different object classes, and will achieve sufficient de-cluttering even where there are large gaps in the scales of coverage available.

Unless the step values outlined in table 2.3 have been manually adjusted, this approach takes no direct account of the relative importance of individual occurrences of an object, and may result in the situation where an object disappears and then reappears as the user zooms out on their ECDIS display. To address these remaining issues, the following additional process steps should be applied:

- Linear and area objects (excluding those objects subject to extensive generalisation e.g. **DEPCNT**) that extend beyond the coverage of a cell and exist in an overlapping smaller Navigational Purpose cell should be assigned the same SCAMIN value as the SCAMIN value of the corresponding object in the smaller scale cell.
- The SCAMIN value of an individual occurrence of an object should be set to either 1, 2, 3 or 4 steps smaller scale than the compilation scale of the smallest scale ENC that the object would appear on (i.e. assuming full coverage across all Navigational Purposes).

The following notes apply to table 2.3:

1. Producers should be prepared to deviate from the step values specified when the significance of the feature dictates, e.g. the recommended number of steps for a **LIGHTS** object is 4, but there will be circumstances where a **LIGHTS** object is so important that no SCAMIN value be applied; alternatively, the light could be so minor that a step value of 1 can be applied.
2. SCAMIN should only be applied to navigational aids where they contribute to “screen clutter” and where their removal from the display does not constitute a risk to safe navigation.
3. It is generally accepted that objects making up a navigational aid will have the same attributes, and therefore those with Master/Slave relationships should be assigned the same SCAMIN value.
4. The elements comprising a range system (see clause 10.1.2) must have the same SCAMIN value, which should be the value corresponding to the largest step value of the objects comprising the range system. For instance, for a range system comprising a **NAVLNE**, **RECTRC** and navigation aids, the decision may be not to apply SCAMIN to the navigation aids (in accordance to Note 2 above), in which case the **NAVLNE** and **RECTRC** must also not have SCAMIN applied. Similarly, all objects comprising a routeing measure (see clause 10.2) should have the same SCAMIN value.

OBJECT	PRIMITIVE	CONDITION	SCAMIN STEPS
<b>ACHARE</b>	Point/ Area		2
<b>ACHARE</b>	Point/Area	If RESTRN defined	3
<b>ACHBRT</b>	Point/Area		1
<b>ADMARE</b>	Area		3
<b>AIRARE</b>	Point/Area	If CONVIS = 1 (visually conspicuous)	3
<b>AIRARE</b>	Point/Area		1
<b>ARCSLN</b>	Line/Area		4
<b>BCNCAR</b>	Point		3 (see Notes 2, 3 & 4 above)
<b>BCNISD</b>	Point		4 (see Notes 2, 3 & 4 above)
<b>BCNLAT</b>	Point		3 (see Notes 2, 3 & 4 above)
<b>BCNSAW</b>	Point		3 (see Notes 2, 3 & 4 above)
<b>BCNSPP</b>	Point		3 (see Notes 2, 3 & 4 above)
<b>BERTHS</b>	Point/Line/Area		1



OBJECT	PRIMITIVE	CONDITION	SCAMIN STEPS
BOYCAR	Point		3 (see Notes 2, 3 & 4 above)
BOYINB	Point		3 (see Notes 2, 3 & 4 above)
BOYISD	Point		4 (see Notes 2, 3 & 4 above)
BOYLAT	Point		3 (see Notes 2, 3 & 4 above)
BOYSAW	Point		3 (see Notes 2, 3 & 4 above)
BOYSPP	Point		3 (see Notes 2, 3 & 4 above)
BRIDGE	Point/Line/Area	Covered by an area <b>DEPARE</b> , <b>DRGARE</b> , or <b>UNSARE</b> object. Note that the point primitive does not display in ECDIS (see clause 4.8.10)	4
BRIDGE	Point/Line/Area	If CONVIS = 1 (visually conspicuous) or CONRAD = 1 (radar conspicuous) and covered by an area <b>LNDARE</b> . Note that the point primitive does not display in ECDIS (see clause 4.8.10)	3
BRIDGE	Point/Line/Area	Covered by an area <b>LNDARE</b> . Note that the point primitive does not display in ECDIS (see clause 4.8.10)	1
BUAARE	Point/Area	If CONVIS = 1 (visually conspicuous) or CONRAD = 1 (radar conspicuous)	3
BUAARE	Point/Area		1
BUISGL	Point/Area	If CONVIS = 1 (visually conspicuous) or CONRAD = 1 (radar conspicuous) or FUNCTN = 33 (light support)	3
BUISGL	Point/Area		1
C_AGGR	N/A		NOT SET
C_ASSO	N/A		NOT SET
CANALS	Line		1
CANALS	Area		4
CAUSWY	Line/Area		2
CBLARE	Area	If RESTRN defined	3
CBLARE	Area		2
CBLOHD	Line	Covered by an area <b>DEPARE</b> , <b>DRGARE</b> , or <b>UNSARE</b> object	4
CBLOHD	Line	If CONVIS = 1 (visually conspicuous) or CONRAD = 1 (radar conspicuous)	3
CBLOHD	Line		1
CBLSUB	Line		3
CGUSTA	Point		1
CHKPNT	Point/Area		1
COALNE	Line		NOT SET
CONVYR	Line/Area	Covered by an area <b>DEPARE</b> , <b>DRGARE</b> , or <b>UNSARE</b> object	4
CONVYR	Line/Area	If CONVIS = 1 (visually conspicuous) or CONRAD = 1 (radar conspicuous)	3

OBJECT	PRIMITIVE	CONDITION	SCAMIN STEPS
CONVYR	Line/Area		1
CONZNE	Area		3
COSARE	Area		3
CRANES	Point/Area	If CONVIS = 1 (visually conspicuous) or CONRAD = 1 (radar conspicuous)	3
CRANES	Point/Area		1
CTNARE	Point/Area		4
CTRPNT	Point		1
CTSARE	Point/Area		1
CURRENT	Point		3
CUSZNE	Area		2
DAMCON	Point/Line/Area		1
DAMCON	Line/Area	If seaward edge is coincident with the coastline (see clause 4.8.5)	NOT SET
DAMCON	Line/Area	If CONVIS = 1 (visually conspicuous) or CONRAD = 1 (radar conspicuous)	3
DAYMAR	Point	If Slave SCAMIN must match that of Master	3
DEPARE	Area		NOT SET
DEPCNT	Line	If VALDCO = 0 (drying line) or 30 (default safety contour ref S-52)	4
DEPCNT	Line		2
DISMAR	Point		2
DMPGRD	Point/Area	If RESTRN defined	3
DMPGRD	Point/Area		2
DOCARE	Area		1
DRGARE	Area		NOT SET
DRYDOC	Area		1
DWRTCL	Line		NOT SET
DWRTPT	Area		NOT SET
DYKCON	Line/Area	If seaward edge is coincident with the coastline (see clause 4.8.7)	NOT SET
DYKCON	Line		1
EXEZNE	Area		3
FAIRWY	Area		3
FERYRT	Line/Area		3
FLODOC	Line	If CONVIS = 1 (visually conspicuous) or CONRAD = 1 (radar conspicuous)	3
FLODOC	Area		NOT SET
FNCLNE	Line	If CONVIS = 1 (visually conspicuous) or CONRAD = 1 (radar conspicuous)	3
FNCLNE	Line		1
FOGSIG	Point	If Slave SCAMIN must match that of Master	3

OBJECT	PRIMITIVE	CONDITION	SCAMIN STEPS
FORSTC	Point/Line/Area	If CONVIS = 1 (visually conspicuous) or CONRAD = 1 (radar conspicuous)	3
FORSTC	Point/Line/Area		1
FRPARE	Area		2
FSHFAC	Point/Line/Area		2
FSHGRD	Area		1
FSHZNE	Area		3
GATCON	Point/Line/Area		2
GATCON	Point/Line/Area	If covered by <b>DEPARE</b> or <b>DRGARE</b> objects; or is coincident with the coastline	NOT SET
GRIDRN	Point/Area	Note that the point primitive does not display in ECDIS (see clause 4.6.6.6)	1
HRBARE	Area		3
HRBFAC	Point/Area		1
HULKES	Point		1
HULKES	Point	If CONVIS = 1 (visually conspicuous) or CONRAD = 1 (radar conspicuous)	3
HULKES	Area		NOT SET
ICEARE	Area		3
ICNARE	Point/Area		1
ICNARE	Point/Area	If RESTRN defined	3
ISTZNE	Area		NOT SET
LAKARE	Area		1
LIGHTS	Point	If Slave SCAMIN must match that of Master	4 (see Notes 2, 3 & 4 above)
LITFLT	Point		4 (see Notes 2, 3 & 4 above)
LITVES	Point		4 (see Notes 2, 3 & 4 above)
LNDARE	Point/Line/Area		NOT SET
LNDELV	Point	If CONVIS = 1 (visually conspicuous)	3
LNDELV	Point/Line		1
LNDMRK	Point/Line/Area	If CONVIS = 1 (visually conspicuous) or CONRAD = 1 (radar conspicuous) or FUNCTN = 33 (light support)	3
LNDMRK	Point/Line/Area		1
LNDRGN	Point/Area		1
LOCMAG	Point/Line/Area		3
LOGPON	Point/Area	Covered by an area <b>DEPARE</b> , <b>DRGARE</b> , or <b>UNSARE</b> object	4
LOGPON	Point/Area		1
LOKBSN	Area		1
M_ACCY	Area		NOT SET
M_COVR	Area		NOT SET

OBJECT	PRIMITIVE	CONDITION	SCAMIN STEPS
M_CSCL	Area		NOT SET
M_HOPA	Area		NOT SET
M_NPUB	Area		NOT SET
M_NSYS	Area		NOT SET
M_QUAL	Area		NOT SET
M_SDAT	Area		NOT SET
M_SREL	Area		NOT SET
M_VDAT	Area		NOT SET
MAGVAR	Point/Line/Area		1
MARCUL	Point/Line/Area	If EXPSOU = 2 (shoaler than range of the surrounding depth area) and VALSOU ≤ 30	4
MARCUL	Point/Line/Area	If RESTRN defined	3
MARCUL	Point/Line/Area		1
MIPARE	Point/Area		3
MORFAC	Point/Line/Area	If CONVIS = 1 (visually conspicuous) or CONRAD = 1 (radar conspicuous)	3
MORFAC	Point/Line/Area		2
NAVLNE	Line		3
NEWOBJ	Point/line/Area		4
OBSTRN	Point/Line/Area		NOT SET
OBSTRN	Point/ Line/Area	If VALSOU > 30 and EXPSOU ≠ 2 (shoaler than range of the surrounding depth area)	4
OFSPLF	Point/Area	Not covered by an area <b>OSPARE</b>	4
OFSPLF	Point/Area	Covered by an area <b>OSPARE</b>	3
OILBAR	Line		4
OSPARE	Area		4
PILBOP	Point/Area		3
PILPNT	Point	Where used to mark position of <b>LIGHTS</b> object in water	4 (see Notes 3 & 4 above)
PILPNT	Point	If CONVIS = 1 (visually conspicuous)	3
PILPNT	Point		2
PIPARE	Point/Area		3
PIPOHD	Line	Covered by an area <b>DEPARE</b> , <b>DRGARE</b> , or <b>UNSARE</b> object	4
PIPOHD	Line	If CONVIS = 1 (visually conspicuous) or CONRAD = 1 (radar conspicuous)	3
PIPOHD	Line		1
PIPSOL	Point/Line	Covered by an area <b>DEPARE</b> , <b>DRGARE</b> , or <b>UNSARE</b> object. Note that the point primitive does not display in ECDIS (see clause 11.6.1)	3
PIPSOL	Point/Line	Covered by an area <b>LNDARE</b> object. Note that the point primitive does not display in ECDIS (see clause 11.6.1)	1
PONTON	Line		2

OBJECT	PRIMITIVE	CONDITION	SCAMIN STEPS
PONTON	Line	If CONVIS = 1 (visually conspicuous) or CONRAD = 1 (radar conspicuous)	3
PONTON	Area		NOT SET
PRCARE	Point/Area		NOT SET
PRDARE	Point/Area	If CONVIS = 1 (visually conspicuous) or CONRAD = 1 (radar conspicuous)	3
PRDARE	Point/Area		1
PYLONS	Point/Area	Covered by an area <b>DEPARE</b> , <b>DRGARE</b> , or <b>UNSARE</b> object	NOT SET
PYLONS	Point/Area	If CONVIS = 1 (visually conspicuous) or CONRAD = 1 (radar conspicuous)	3
PYLONS	Point/Area		1
RADLNE	Line		3
RADRFL	Point	If Slave SCAMIN must match that of Master	3
RADRNG	Area		3
RADSTA	Point	If Slave SCAMIN must match that of Master	2
RAILWY	Line		1
RAPIDS	Point/Line/Area	Note that the point primitive does not display in ECDIS (see clause 4.7.7.1)	1
RCRTCL	Line		3
RCTLPT	Point/Area		3
RDOCAL	Point/Line		3
RDOSTA	Point	If Slave SCAMIN must match that of Master	1
RECTRC	Line/Area		3
RESARE	Area		3
RETRFL	Point	If Slave SCAMIN must match that of Master	3
RIVERS	Line		1
RIVERS	Area		4
ROADWY	Point/Line/Area	Note that the point primitive does not display in ECDIS (see clause 4.8.8)	1
RSCSTA	Point		3
RTPBCN	Point	If Slave SCAMIN must match that of Master	3
RUNWAY	Point/Line/Area	If CONVIS = 1 (visually conspicuous). Note that the point primitive does not display in ECDIS (see clause 4.8.12)	3
RUNWAY	Point/Line/Area	Note that the point primitive does not display in ECDIS (see clause 4.8.12)	1
SBDARE	Point/Line/Area		1
SEAARE	Point/Area		1
SILTNK	Point/Area	If CONVIS = 1 (visually conspicuous) or CONRAD = 1 (radar conspicuous)	3
SILTNK	Point/Area		1
SISTAT	Point	If Slave SCAMIN must match that of Master	1
SISTAW	Point	If Slave SCAMIN must match that of Master	1

OBJECT	PRIMITIVE	CONDITION	SCAMIN STEPS
SLCONS	Point/Line/Area		NOT SET
SLOGRD	Point/Area	If CONVIS = 1 (visually conspicuous) or CONRAD = 1 (radar conspicuous)	3
SLOGRD	Point/Area		1
SLOTOP	Line	If CONVIS = 1 (visually conspicuous) or CONRAD = 1 (radar conspicuous)	3
SLOTOP	Line		1
SMCFAC	Point/Area		1
SNDWAV	Point/Line/Area		3
SOUNDG	Point		1
SPLARE	Point/Area	If RESTRN defined	3
SPLARE	Point/Area		1
SPRING	Point		1
STSLNE	Line		3
SUBTLN	Area		3
SWPARE	Area		3
T_HMON	Point/Area		1
T_NHMN	Point/Area		1
T_TIMS	Point/Area		1
TESARE	Area		3
TIDEWY	Line/Area		1
TOPMAR	Point	If Slave SCAMIN must match that of Master	3
TS_FEB	Point/Area		3
TS_PAD	Point/Area		2
TS_PNH	Point/Area		2
TS_PRH	Point/Area		2
TSELNE	Line/Area		NOT SET
TSEZNE	AREA		NOT SET
TSSBND	Line		NOT SET
TSSCRS	Area		NOT SET
TSSLPT	Area		NOT SET
TSSRON	Area		NOT SET
TS_TIS	Point/Area		2
TUNNEL	Line/Area	Covered by an area <b>DEPARE</b> , <b>DRGARE</b> , or <b>UNSARE</b> object. Note that the point primitive does not display in ECDIS (see clause 4.8.3)	4
TUNNEL	Line/Area	Covered by a <b>LNDARE</b> object. Note that the point primitive does not display in ECDIS (see clause 4.8.3)	1
TWRTPT	Area		NOT SET
UNSARE	Area		NOT SET
UWTROC	Point		NOT SET

OBJECT	PRIMITIVE	CONDITION	SCAMIN STEPS
UWTROC	Point	If VALSOU > 30 and EXPSOU ≠ 2 (shoaler than range of the surrounding depth area)	4
UWTROC	Point	Covered by an area <b>OBSTRN</b> object	2
VEGATN	Point/Line/Area	If CONVIS = 1 (visually conspicuous)	3
VEGATN	Point/Line/Area		1
WATFAL	Point/Line	If CONVIS = 1 (visually conspicuous). Note that the point primitive does not display in ECDIS (see clause 4.7.7.2)	3
WATFAL	Point/Line	Note that the point primitive does not display in ECDIS (see clause 4.7.7.2)	1
WATTUR	Point/Line/Area		3
WEDKLP	Point/Area		3
WRECKS	Point/Area		NOT SET
WRECKS	Point/Area	If CATWRK = 1 or (VALSOU > 30 and EXPSOU ≠ 2 (shoaler than range of the surrounding depth area))	3
WRECKS	Point/Area	CONVIS = 1 (visually conspicuous) or CONRAD = 1 (radar conspicuous)	3

Optional additional rules that can be manually applied to fine tune the application of SCAMIN after the above values have been automatically applied.

OBJECT	PRIMITIVE	CONDITION	SCAMIN STEPS
OBSTRN	Point	The most significant <b>OBSTRN</b> of a group of <b>OBSTRNs</b> within close proximity	NOT SET
OBSTRN	Point	For groups of <b>OBSTRNs</b> in close proximity, or within an <b>OBSTRN</b> area	2
SOUNDG	Point	SCAMIN should be applied so that the least significant soundings are set to 1 step progressing to 4 steps for the most significant, above the compilation scale in order to achieve a gradual reduction in the sounding displayed as the user zooms out.	1, 2, 3, 4
UWTROC	Point	The most significant <b>UWTROC</b> of a group of <b>UWTROCs</b> within close proximity and not within an <b>OBSTRN</b> area	NOT SET
WRECKS	Point/Area	For groups of <b>WRECKS</b> in close proximity (the most significant should not have SCAMIN)	2

table 2.3

## 2.3 Textual information

The attributes INFORM, NINFOM, TXTDSC and NTXTDS should not be used when it is possible to encode the information by means of any other attribute. Under certain ECDIS display settings the “information” symbol will display when these attributes are populated. Therefore producers should carefully consider use of these attributes as the symbol may contribute significantly to ECDIS screen clutter.

INFORM and NINFOM contain information as text, whereas TXTDSC and NTXTDS encode the name of an external file.

The text contained in INFORM and NINFOM is ASCII text. Formatting characters (C0 as defined in S-57 Part 3, Annex B) are prohibited. INFORM and NINFOM should generally be used for short notes or to transfer information which cannot be encoded by other attributes, or to give more detailed information about an object. As a guide, text populated in INFORM and NINFOM should not exceed 300 characters.

The text files referenced by TXTDSC and NTXTDS must be ASCII files (.TXT), and may contain formatted text. These files should generally be used for longer texts (e.g. longer chart notes, tables or paragraphs from Sailing Directions), but should not be used to replicate large blocks of text (e.g. entire chapters of Sailing Directions) that can be found in other Nautical Publications, which may not be suitable for viewing in ECDIS. It is up to the Producing Authority to determine the most suitable means of encoding a particular piece of text.

The exchange language must be English. Other languages may be used as a supplementary option. In general this means that, when a national language is used in the textual national attributes (NINFOM, NOBJNM, NPLDST), the English translation must also exist in the international attributes (INFORM, OBJNAM, PILDST).

Remarks:

- Clause 5.4.1 of S-57 Appendix B.1 – ENC Product Specification, specifies the content of an ENC exchange set, including the option to include text files. The clause mandates the use of ASCII text as the format to be used for these files, but states additionally that “Files in other formats (including application files that may be used to manipulate text or picture files) may be included in an exchange set by private agreement between the producer and the receiver”. Additionally, clause 5.6.4 also mandates the use of ASCII text file formats for text files, but states additionally “Files in other formats, provided through private agreements, should follow the same general naming convention and use the appropriate file extension to indicate their format”.

Many Type Approved ECDIS's have been developed to accept only ASCII text files when generating the SENC as mandated in the ENC Product Specification. This has resulted in these ECDIS's failing to load text files in formats other than .TXT.

Encoders are therefore advised that, when creating ENC exchange sets for general navigational distribution, to include text files **only in text (.TXT) format**.

Text files in formats other than .TXT should only be distributed in ENC exchange sets where a private agreement has been made **with every ECDIS provider** to utilise these alternative formats.

- In some cases, for external files referenced by the attribute NTXTDS, encoders have created text files using local character encoding that may not be interpreted correctly by an ECDIS and therefore not readable by the user. Encoders are strongly advised to encode national text files (NTXTDS) using the same character encoding used for the NATF field as defined in S-57 Part 3 clause 2.4. This means that the encoding of the characters in text files must match the encoding of other textual national attributes (e.g. NOBJNM, NINFOM) within the data set.

## 2.4 Colours and colour patterns

If it is required to encode multiple colours on an object, they must be interpreted and encoded using the attributes COLPAT and COLOUR as follows:

- For horizontal stripes (COLPAT = 1), the first colour in the list must be the top-most, and subsequent colours follow sequentially from top to bottom. For example, COLOUR = 3,1 to encode a red stripe above a white stripe.
- For vertical stripes (COLPAT = 2), the first colour in the list must be the left-most, and subsequent colours follow sequentially from left to right. For example, COLOUR = 3,1,3 to encode red, white, red vertical stripes.
- For diagonal stripes (COLPAT = 3), the first colour in the list must be the top-left-most and subsequent colours follow sequentially from top left to bottom right. For example, COLOUR = 1,3,1,3,1 to encode white, red, white, red, white diagonal stripes.
- For squares (COLPAT = 4), the first colour in the list must be the top-left-most square. Subsequent colours follow sequentially from left to right along the top row then repeated for subsequent rows until the bottom right-most square is reached. For example, COLOUR = 1,3,3,1 to encode white, red squares on the top row, and red, white squares on the bottom row.
- For border stripes (COLPAT = 6), the first colour in the list must be the border stripe, the second colour must be that of the background. For example, COLOUR = 3,1 to encode a red border stripe on a white background. Where a border stripe is combined with other patterns, the border stripe



must be the first colour in the list, and subsequent colours must be interpreted in accordance with the rules defined for the additional patterns. Therefore, if a pattern contains a border stripe as well as other patterns, the border stripe must be the first value in the list of COLPAT.

Note that the attribute COLPAT is mandatory for any object (except **LIGHTS**) that has more than one colour.

## 2.5 Reference to other publications

If it is required to encode a reference to other nautical information or publications, it must be done using the meta object **M\_NPUB**.

Meta object: Nautical publication information (**M\_NPUB**) (P,A)  
 Attributes: INFORM NINFOM

Remarks:

- References to nautical publications in **M\_NPUB** must be encoded using the attribute PUBREF, and references to external picture files must be encoded using the attribute PICREP.
- **M\_NPUB** should also be used to encode information which may be of use to the mariner, but is not significant to safe navigation and cannot be encoded using existing feature objects, using the attributes INFORM and/or TXTDSC (see clause 2.3). As **M\_NPUB** of type area do not display in ECDIS, such areas should be encoded to cover the entire area of data coverage for the cell. This is intended to reduce the number of alarms or indications generated in the ECDIS due to the overuse of **CTNARE** objects (see clause 6.6).

## 2.6 Updating

Remarks:

- An ENC Update will be rejected by the ECDIS if it is located outside the area of data coverage for the cell (i.e. area covered by the meta object **M\_COVR** with attribute CATCOV = 1 (coverage available)) or if it changes the extent of this area. Where the area of data coverage for a base ENC cell is to be changed, this must be done by issuing a New Edition of the cell.
- It has been reported that some ECDIS experience problems in loading large Update data sets. Therefore, as a guide, ENC Updates should not exceed 50 Kilobytes in size.
- When updating the geometry of linear features, compilers must note S-57 Part 3 clause 4.7.2 regarding the requirement for the vector records making up the linear feature to be referenced sequentially. Additionally, for linear features comprising multiple edges, the end node of a vector record must be the same as the start node of the following vector record. It has been reported that some ECDIS reject ENC Updates where the geometry does not conform to these requirements.

### 2.6.1 Issuing Updates in advance

Under certain conditions, it may be necessary for a data producer to issue Update information in advance. For example, a change in a traffic routing system must be made public before the new situation is implemented. Within an ER data set there is no means of indicating the date at which an Update must be applied. Therefore, when an ER data set is received by an end user, it must be applied immediately. To avoid situations where Update information would cause target data to reflect a situation that does not yet exist, the following encoding rules must be followed:

a) If the advance Update information contained in the Update message involves the addition of objects to the existing data (e.g. a new lighthouse), the attribute DATSTA on the new objects must contain the date at which the Update becomes active.

b) If the advance Update information contained in the Update message involves the modification of existing objects (e.g. a change in a traffic routing system), it must be treated as a deletion of the existing objects and replacement with new objects. See a) above and c) below.

c) If the advance Update information contained in the Update message involves the deletion of existing objects (e.g. the removal of a buoy), the Update message must set the DATEND attribute of all objects to be deleted to the date at which the Update becomes active. **NB.** This Update message does not actually delete the objects from the data set, it simply indicates that on the date held in

DATEND they become obsolete. A further Update to actually delete the obsolete objects from the data set should be sent at the time that the change in the real world occurs.

d) To highlight to the mariner that the advance Update information contained in an Update message will take place in the future, it is recommended that a caution area object (**CTNARE**) be created covering the location at which the future changes will take place. A warning note specifying, in plain language, the nature of the future change should be encoded, either in the attribute INFORM or in a file referenced by the TXTDSC attribute of the **CTNARE**. The attribute DATEND on the **CTNARE** must be set to the date at which the change described in the Update becomes active.

Changes to DATSTA and DATEND cannot be applied to spatial objects. Therefore, a change to the geometry of a real world object (e.g. the relocation of a buoy) to be applied in the future can only be achieved by updating all of the feature and spatial objects involved.

As a consequence of issuing advance information Updates, more than one instance of a particular real world object could exist in the data set.

Further information regarding issuing Update information in advance as an equivalent to the paper chart Preliminary Notices to Mariners process can be found at clause 2.6.2.3.

### 2.6.1.1 Advance notification of changes to traffic separation schemes

It is important that mariners be provided with advance notification of changes to traffic separation schemes (TSS), which may include modification to an existing TSS, addition of a new TSS or removal of a TSS. In order to provide a consistent approach to mariners regarding advance notification of changes to a traffic separation scheme, the following procedure should be adopted:

1) At least one month before the changes to the TSS come into force, issue an updated data set (as an Update or a New Edition) which:

- Adds new or amended TSS component objects. These objects must have DATSTA populated with the date that the changes to the TSS come into force.
- Adds DATEND (populated with the date of the day before the changes to the TSS come into force) to any component objects of the existing TSS that are to be changed or deleted.
- Creates a **CTNARE** area object (see clause 6.6) covering the geographic extent of both the current and the future TSS. The attribute INFORM or TXTDSC must be used to explain the change to the TSS, e.g. *“The traffic separation scheme off Cape Bon is to be modified at 0000 UTC on 1 July 2009. This ENC includes all the information before and after the change, indicated by the attributes DATEND (before the change) and DATSTA (after the change) on the components of the scheme”*. The attribute DATEND for the **CTNARE** should be populated with the date at which the change comes into force or, if encoders wish to provide extended information to the mariner that a change has been made, with a date up to a month after the change comes into force. If the current and the future TSS are not in the same geographic area, it may be required to encode two distinct **CTNARE** area objects. A picture file may be referenced by a **M\_NPUB** object (see clause 2.5) sharing the same geometry as the **CTNARE** using the attribute PICREP if it is considered useful, e.g. the equivalent paper chart representation of the amended or new TSS. As **M\_NPUB** objects of type area do not display in ECDIS a reference that a related **M\_NPUB** object exists should be included using the attributes INFORM or TXTDSC for the **CTNARE**.

2) As soon as possible after the modified/new/deleted TSS comes into force, issue an updated data set (as an Update or New Edition) which:

- Deletes the changed or redundant component objects of the former TSS.
- Removes the attribute DATSTA from the component objects of the new TSS.

3) The **CTNARE** (and **M\_NPUB** if encoded) must also be removed by Update, either as part of the Update to remove the redundant component objects of the former TSS, or as a separate Update at a later date, corresponding to the date populated in the attribute DATEND for the **CTNARE**.

Encoders who are members of RENCs should also provide advance notification of changes to TSS to their RENC in accordance with RENC procedures, in order for the RENC to provide additional notification to mariners of impending TSS changes.

## 2.6.2 Guidelines for encoding Temporary and Preliminary ENC Updates

### 2.6.2.1 Introduction

The following provides high level guidance for the promulgation of the equivalent of paper chart Temporary (T) and Preliminary (P) Notices to Mariners (NMs) via ENC Updates. This guidance allows for some latitude in its application and is dependant on the assessment of each particular case, and as such relies ultimately on the judgement of each ENC Producing Authority.

### 2.6.2.2 Temporary (T) Notices to Mariners (see S-4 – B-633)

1. Temporary Notices to Mariners, (T)NMs, for paper charts are defined in S-4, Section B-600. A (T)NM promulgates navigationally significant information that will remain valid only for a limited period of time.

For the paper chart, the convention is for the mariner to insert the Update on the chart in pencil, and erase it when the (T)NM is cancelled.

S-57 provides mechanisms which allow ENC(s) to be automatically updated (ER application profile<sup>1</sup>). This allows the affected ENC(s) to be continually updated in a timely manner for the duration of the NM without additional workload for the mariner.

Producing Authorities should promulgate temporary navigationally significant information by ENC Update to provide the ECDIS user with an updated SENC. This service corresponds to the service that (T)NMs offer to the paper chart user.

2. ER encoding for an ENC and (T)NM for the paper chart are two completely different communication processes for promulgating information to the mariner. Since these processes are different (but not supposed to be independent), and the products to which they apply are also different, it is recommended that ENC Updates be derived from the source information rather than the paper chart (T)NM. Often the (T)NM for paper chart does not provide enough detail to apply the relevant ENC Update.
3. If possible the information should be encoded with the relevant S-57 objects. However, HOs should consider the following:
  - An ENC Update must not be initiated if the information will no longer be valid by the time it is received by the mariner; this will depend upon the timescales relating to the Producer Nation's ENC Updating regime. Shorter time periods may be covered by Radio Navigational Warnings (RNW). If known, the ENC Update should include an indication of how long the temporary change will remain in force.
  - If it is unlikely that the HO will be notified when a temporary change will revert to its original charted state, the HO should consider an alternative method such as a general note or by issuing an ENC Update explaining, for example, that the aids to navigation within an area are reported to be unreliable.

It is important that HOs should consider constraints of time when identifying the encoding method. Time consuming and unnecessarily complex methods of encoding should be avoided.

4. The overuse of **CTNARE** objects (especially **CTNARE** of type area – see clause 6.6) for temporary information should be avoided. The **CTNARE** object is used when it is relevant for the situation and/or when a particular change needs a special warning. **CTNARE** may be used when the relevant objects cannot be encoded, e.g. information cannot be displayed clearly or cannot be easily promulgated due to time constraints.
5. To correctly encode an ENC Update the source information is essential in determining which elements of the Update are reliable, which are permanent and which are temporary. The attribute STATUS with value 7 (temporary) should only be used in an Update when it is certain that the status of an object is confirmed as temporary.

---

<sup>1</sup> The ER application profile only applies to ENC Update cell files. S-57 Appendix B.1 - ENC Product Specification refers

6. Use of attributes DATSTA and DATEND:

The earliest date on which an object will be present (DATSTA) and the latest date on which an object will be present (DATEND) must only be encoded when known. When these dates are encoded for navigational aids, DATSTA and DATEND must be populated on each component of the aid.

The ENC Update should be issued as close as possible to the earliest date of the change (DATSTA), unless it is appropriate to provide the information well in advance. An object no longer present should be removed from the display by issuing a further Update as soon as possible after the return to the original charted state (DATEND). The timing of the issue of these Updates will depend upon the Producing Authority's ENC Updating regime and its corresponding timescales.

When an ENC Update promulgates information well in advance and uses DATSTA and DATEND, a **CTNARE** object may be used in order to inform mariners that temporal information exists at some future point in time.

NOTE: some older legacy ECDIS's may not have the functionality to manage temporal information correctly or may have implemented it incorrectly. Some ENC producers may wish to include additional encoding to safeguard against this. For example, insert a **CTNARE** describing the changes and timings.

7. The attribute INFORM should be used to provide supplementary or contextual information when encoding temporary (or preliminary) information. When the text is too long to be encoded using INFORM (see clause 2.3), the attribute TXTDSC should be used. Encoders using INFORM/TXDSC to provide positional information must express the coordinate values in WGS 84 and in accordance with S-4 – B-131. If it is deemed necessary a picture file (PICREP) may be referenced. If the relevant object class (e.g. **CTNARE**) does not have PICREP as an allowable attribute, then PICREP may be populated for a **M\_NPUB** object (see clause 2.5) which shares the same geometry as the relevant object. As **M\_NPUB** objects of type area do not display in ECDIS a reference that a related **M\_NPUB** object exists should be included using the attributes INFORM or TXTDSC for the associated object.
8. ENC Updates issued for temporary information should be carefully managed and reviewed regularly to consider whether further action is necessary. New information may have been received that necessitates the issuing of a new Update to modify or cancel the previous one. Producing Authorities should make it easy to recover the original charted state before the temporary changes came into effect.
9. Further verification is recommended to make sure that the encoded ENC Update is consistent with the corresponding paper chart NM.

10. Guidelines for typical cases:

- a) Individual new physical objects (e.g. wreck, buoy) with no associated explicit or implicit area associated (e.g. restricted area):
  - Encode the relevant S-57 object.
  - In this instance a **CTNARE** object would not normally be used.
- b) Individual new physical object with an associated explicit area around it:
  - Encode the relevant S-57 area object (e.g. **RESARE**). The relevant object is encoded for the new physical object. However, when the area is an "entry prohibited area" or a **CTNARE** object the new physical object may be omitted to simplify encoding unless it is navigationally significant.
- c) Individual new physical object with a notification of caution, e.g. "Mariners are advised to navigate with caution...":
  - Encode the relevant S-57 object. Additional clarification and advice may, if required, be provided using attributes INFORM or TXTDSC. Exceptionally, a **CTNARE** object may be encoded to highlight the caution if considered necessary.
- d) Obstructions (including wrecks) reported to exist within an area:
  - Encode an **OBSTRN** or **WRECKS** object of type area (see clauses 6.2.1 and 6.2.2).

- e) New simple area object (military practice area, dredged area):
  - Encode the relevant S-57 area object.
  - Supplementary information is provided using attributes INFORM or TXTDSC.
  - Normally, a **CTNARE** object is not added.
- f) Complex information within an area (e.g. works in progress where the changes are numerous or involve complex changes to the topology):
  - Encode the area object. It should be encoded with the relevant S-57 object or, if more suitable or by default, a **CTNARE** object (see clause 6.6). Supplementary or contextual information is provided using attributes INFORM or TXTDSC. When the available information is sufficiently detailed, navigationally significant objects (e.g. navigational aids, obstructions) should be encoded or modified within the area. When the available information does not permit this, a **CTNARE** object defining the area is preferred.
- g) Changes to an existing object (e.g. navigational aid):
  - In these instances it is usually only necessary to change the attributes values. A **CTNARE** object (see clause 6.6) may be used to warn the mariner if it is considered necessary.
- h) Buoy temporarily moved:
  - When a buoy is temporarily moved then it, and any associated objects, are “moved” to the new position and the attribute STATUS = 7 (temporary) is populated. Alternative encodings are possible, for example, if the move is for a fixed period of time. In these cases the object, and any associated components, can be created in the temporary position with attribute DATEND populated with the date corresponding to the end of the fixed period of time. The currently charted object, and any associated components, should have DATSTA also populated with the date corresponding to the end of the fixed period of time. A **CTNARE** object may, if considered necessary, be added. Data producers may wish to consider the NOTE in section 6 above.
- i) Light temporarily extinguished:
  - The attribute STATUS for the **LIGHTS** object is populated with the values 11 (extinguished) and 7 (temporary).
- j) Change to a maintained depth in a dredged area:
  - When information is received from an official or recognised survey authority relating to a dredged area where the dredged depth has changed, the attribute value of DRVAL1 for the **DRGARE** object should be changed to the value provided by the survey.
  - Where a **SOUNDG** object is encoded in a dredged area to indicate shoaler depths, the attribute value EXPSOU = 2 (shoaler than the depth of the surrounding depth area) should not be populated (see clause 5.3). Where required, the shoal depths should be encoded using **SOUNDG**, with the appropriate underlying depth information (**DEPARE** and, if required, **DEPCNT**) to support the depths. Alternatively, the attribute DRVAL2 for the **DRGARE** may be set to the designed dredged depth for the dredged area and the attribute DRVAL1 set to the value of the shoalest depth, or a **CTNARE** object may be encoded covering the shoaler depth area with the depth information provided using the attribute INFORM. Where the shoal depths are close to the edge of the dredged area, the dredged area limit may be adjusted to exclude the shoal depths from the area. See also S-4 – B-414.5.

### 2.6.2.3 Preliminary (P) Notices to Mariners (see S-4 – B-634)

1. Preliminary Notices to Mariners, (P)NMs, for paper chart are defined in S-4, Section B-600. A (P)NM promulgates navigationally significant information early to the mariner e.g. when a paper chart new edition cannot be issued in due time.

For the paper chart, the convention is for the mariner to insert the Update on the chart in pencil, and erase it when the (P)NM is cancelled.

S-57 provides mechanisms which allow ENCs to be automatically updated (ER application profile). This allows the affected ENC(s) to be continually updated in a timely manner for the duration of the NM without additional workload for the mariner.

Producing Authorities should promulgate preliminarily navigationally significant information by ENC Update to provide the ECDIS user with an updated SENC. This method of delivery corresponds to the service that (P)NMs offer to the paper chart user.

2. ER encoding for ENC and (P)NM for paper chart are two completely different communication processes for promulgating information to the mariner.

For example, there are instances when the paper chart needs updating using a NM block (also known as a chartlet or patch) or by issuing a New Edition due to the complexity or volume of changes. This could clutter the paper chart unacceptably if amended by hand and/or overburden the chart corrector. The lead time for a NM block correction or a New Edition can be lengthy, sometimes several months. In these cases a (P)NM may be issued as an interim measure. The ENC Updating mechanisms are more flexible and may allow for ENC Updates to be issued in quicker time. However, experience has shown that large Updates may result in processing issues in the ECDIS, in particular inordinately long loading times. Therefore producing an ENC New Edition may be the better option in some cases.

There may be other instances, when new information is received, where it is not possible to fully update both the ENC and paper chart promptly. For example, not all the information required to produce a chart-updating NM is received by the HO in the first notification (for instance notification of works in progress or projected), or extensive new information requires significant compilation work. In these cases it is still necessary to provide notification of navigationally significant changes to the mariner in a timely manner.

Since the paper chart and ENC processes are different (but not supposed to be independent), and also the products to which they apply are different, it is recommended that ENC Updates be derived from the source information rather than from the paper chart (P)NM. It is often the case that the paper chart (P)NM does not provide enough detail to encode the ENC Update exactly as it should be.

3. Simple or more complex encoding methods are possible but it is important for Producing Authorities to consider carefully which encoding method is appropriate when creating an ENC Update with due consideration for time.
4. Often, information received is too complex, extensive and/or imprecise to be encoded with the relevant S-57 objects. In these instances the use of a **CTNARE** object (see clause 6.6) and attribute INFORM is preferred to give a précis of the overall changes together with detailed navigationally significant information. For complex or extensive changes the **CTNARE** should have an associated TXTDSC referencing a file containing precise details of the preliminary information. See also clause 2.6.2.2 section 7 above. If the information is less precise then INFORM for the **CTNARE** should be used to inform mariners of this fact.

It is noted that the mariner, if it is considered necessary, has the facility in the ECDIS to add "Mariner Objects" and annotate them. These can be saved in the SENC based on information provided in textual form using the TXTDSC or INFORM attributes. It is envisaged that these objects would be created at the "Route Planning" stage and act as a prompt during the "Route Monitoring" phase.

When information is issued as advance notification for an ENC it is necessary to provide as soon as possible to the mariner the final and full charted information encoded with the relevant S-57 objects. An ENC Update or a New Edition of the ENC cell should therefore be issued at a later date when the Producing Authority can carry out full encoding of the changes. The period of time will depend on the following:

- the time needed by the HO to undertake the full encoding with relevant objects;
- the time needed to obtain confirmation of details; and
- the date at which the real world situation is stabilized and any forecast changes have been completed.

5. Source Information received may contain some navigationally significant elements that are simple to encode with the relevant objects in a timely manner. In such cases these elements may be encoded with the relevant objects provided that they reflect the "real world" situation after the ENC

Update is made available to the user. However, if the changes are subject to continual change these objects should be amended as a consequence and will represent additional work for the HO. In such cases, the ENC Update should also warn the mariner that the situation is subject to change. For temporary information, see clause 2.6.2.2.

6. Use of attributes DATEND and DATSTA: see clause 2.6.2.2 section 6. For new or amended routing measures, see clause 2.6.1.1.
7. Use of attribute INFORM: see clause 2.6.2.2 section 7.
8. Diagrams are sometimes very useful to the mariner, e.g. for indicating changes to complex routing measures or the introduction of new ones. A picture file may be referenced using the attribute PICREP in such cases. As PICREP is not a valid attribute for the object class **CTNARE**, the picture file may be referenced by a **M\_NPUB** object (see clause 2.5) which shares the same geometry as the **CTNARE**. As **M\_NPUB** objects of type area do not display in ECDIS a reference that a related **M\_NPUB** object exists should be included using the attributes INFORM or TXTDSC for the **CTNARE**.
9. ENC Updates issued for preliminary information should be managed and reviewed regularly. For example further source information may have been acquired requiring a further ENC Update. This may add, modify or cancel information previously promulgated.
10. Further verification is recommended to make sure that the encoded ENC Update is consistent with the corresponding paper notice.

#### 11. Guidelines for typical cases:

##### a) Traffic separation schemes:

- See clause 2.6.1.1. For the use of the attributes DATSTA and DATEND, see also clause 2.6.2.2 section 6.

##### b) Complex information within an area of change (e.g. works in progress):

- A **CTNARE** object (see clause 6.6) should be created to cover the area. Information is provided using either attribute INFORM, e.g. *under construction*, or attribute TXTDSC when it is necessary to give more detailed information. If sufficiently detailed information is available, then navigationally significant information such as navigational aids, fairways, regulated areas, etc. can be encoded or modified within the **CTNARE** if time permits.
- As the **CTNARE** object does not have PICREP as an allowable attribute, any picture file required may be referenced by a **M\_NPUB** object (see clause 2.5) which shares the same geometry as the **CTNARE**. As **M\_NPUB** objects of type area do not display in ECDIS a reference that a related **M\_NPUB** object exists should be included using the attributes INFORM or TXTDSC for the **CTNARE**.
- Alternatively, and if considered appropriate a **RESARE** object (see clause 11.1), with attribute RESTRN = 7 (entry prohibited) may be encoded instead the **CTNARE** object.

##### c) Simple information which does not need an additional notification of caution:

- The relevant object(s) and the appropriate attributes should be encoded with any additional contextual information provided using the attributes INFORM or TXTDSC. In this case it is not necessary to use a **CTNARE** object. This could apply, for example, to submarine cables or pipelines being laid (**CBLSUB** or **PIPSOL** objects), or an area under reclamation (**LNDARE** object with attribute CONDTN = 3 (under reclamation)). If required the encoding should reflect that positions are approximate using the spatial attribute QUAPOS = 4 (approximate) on the spatial object(s).

##### d) Depths less than those charted within a defined area:

- If the depth values and their positions are known, **SOUNDG** objects (see clause 5.3) may be created or modified. Any affected depth contours and depth areas should also be amended as necessary (see clause 5.3 Note). The source of the information should be encoded using the attribute SORIND. However, Producing Authorities should carefully consider the time needed to update ENC depth information and the complexity of changes to the topology that may be required. The encoding of amended **SOUNDG**, **DEPARE** and associated objects could be inappropriate for promulgating this navigationally significant

information within acceptable time scales. In this case a **CTNARE** (see clause 6.6) is the preferred option. In such cases, only the most significant amendments to depth information should be provided using the attributes **INFORM** or **TXTDSC**. This method should also be used if the depth values and/or the exact positions are unknown, or if the Producing Authority only has information relating to a limited number of depth values.

## 2.7 Multiple objects and objects shown out of position on paper charts

On some sources, multiple objects in close proximity are generalised to a single object with a text string indicating the presence of the other objects. In such cases, where it is considered that this information may be useful for visual navigation, one object of the appropriate class should be encoded and the true number of objects should be encoded using the attribute **INFORM** (e.g. 3 *chimneys*) on this object. If the true number of objects is not known, the text "*more than one*" should be encoded using **INFORM**.

Multiple submerged objects in close proximity, which have been generalised to a single object, should not have **INFORM** populated unless the multiplicity has some significance to safe navigation. This is so as to minimise the presence of ECDIS "information" symbols, which may contribute to screen clutter (see clause 2.3).

For the encoding of multiple, identical lights using the attribute **MLTYLT**, see table 12.5 in clause 12.8.7.

For the encoding of leading lights that are merged on the source document, see clause 12.8.6.4.

On paper charts, objects such as buoys may be displaced from their real world position in order to allow for the depiction of underlying hazards. Where ENCs are captured from paper charts this displacement may then be carried onto the ENC. As a result of the ability of ECDIS users to zoom in to inappropriate scales this can result in an ECDIS display which is not an accurate representation of reality. There is no method within ENC to indicate to the mariner that an object has not been encoded in its true position, therefore it is considered important for objects to be encoded in their true position to provide the mariner with an accurate representation of the real world.

Encoders are advised, therefore, that if it is required to encode a feature which has been displaced on the paper chart for cartographic reasons, it should be captured in its real-world position on the ENC.

## 2.8 Minimal depiction areas (see S-4 – B-404)

Where minimal depiction areas exist within a specified ENC navigational purpose, they should be encoded using one of the following options:

### 2.8.1 Wide blank areas

Areas of a data set which contain no data must be covered using the meta object **M\_COVR**, with attribute **CATCOV** = 2 (no coverage available). Note that ENC cells must be completely covered by **M\_COVR** objects. The areas that contain data must be covered by **M\_COVR** with **CATCOV** = 1 (coverage available). The spatial extent of the **M\_COVR** objects comprising an ENC data set should be restricted to the spatial extent of the minimum bounding rectangle formed by the area of the cell covered by data (**M\_COVR** with **CATCOV** = 1 (coverage available)).

Producing Authorities should not leave "holes" (i.e. areas covered by **M\_COVR** with attribute **CATCOV** = 2 (no coverage available)) in smaller scale coverage, under the assumption that the ECDIS user will have the larger scale data available.

### 2.8.2 Simplified or minimal depiction areas

- Bathymetry in such areas should be encoded as described in clause 5.8.3.
- Information that does not relate to bathymetry but is relevant to Group 1 objects (islands, shoreline constructions, floating docks, hulks etc) may be encoded.



- One **CTNARE** object covering the whole area should be created. The attributes INFORM or TXTDSC should be encoded using one of the following options (the textual content of the attributes is within quotation marks and italicised):

Where larger scale coverage is available:

*“Most features, including bathymetry, are omitted in this area. The minimal depiction of detail in this area does not support safe navigation; mariners should use a more appropriate navigational purpose.”*

Any other information contained in chart notes pertaining to the area should be incorporated within, or replace completely, the above statement.

Where no larger scale coverage is available:

*“Most features, including bathymetry, are omitted in this area. The minimal depiction of detail in this area does not support safe navigation.”*

This statement should be supplemented by additional cautionary information from chart notes relating to any authority to be consulted before navigating in the area.

### 3 Time Varying Objects

#### 3.1 Magnetic data (see S-4 – B-270)

##### 3.1.1 Magnetic variation

Until a world magnetic model is universally available for inclusion in ECDIS, if it is required to encode magnetic variation, it must be done using the object class **MAGVAR**. As a minimum, Updates should be supplied to coincide with changes of epoch (i.e. every five years).

Geo object: Magnetic variation (**MAGVAR**) (P,L,A)  
 Attributes: DATEND DATSTA RYRMGV VALACM VALMAG INFORM NINFOM

Remarks:

- There remains a requirement to include magnetic variation information in ENCs whilst SOLAS regulations include the requirement for a magnetic compass and deviation card. User feedback indicates that it can be difficult to access magnetic variation information in ECDIS where it has been encoded using the point or line primitive. In order to make magnetic variation information easily available to ECDIS users, it is recommended to encode this information using **MAGVAR** objects of type area. Encoding this information using the area primitive ensures that the user can interrogate the ENC data using the ECDIS Pick Report function at any chart location to identify the value of magnetic variation at that location.

##### 3.1.2 Abnormal magnetic variation (see S-4 – B-274)

If it is required to encode an abnormal magnetic variation in a localised area, it must be done using the object class **LOCMAG**.

Geo object: Local magnetic anomaly (**LOCMAG**) (P,L,A)  
 Attributes: NOBJNM OBJNAM VALLMA INFORM NINFOM

If the area cannot be defined, the feature should be represented as a point object.

When the deviation for an area makes reference to a range rather than a specific value, the range of values should be indicated using the attribute INFORM (e.g. *From -27 degrees to 3 degrees*).

#### 3.2 Tidal data (see S-4 – B-406)

The inclusion of tidal information in ENC data sets is optional.

For Standard Ports the appropriate national Hydrographic Office, or an organisation authorised by it, should provide the predictions.

For Secondary Ports, the appropriate Hydrographic Office, or an organisation authorised by it should, where possible, provide the predictions. Should such predictions not be available, the ECDIS manufacturer should approach the appropriate national Hydrographic Office for advice regarding the best methods of prediction for the Secondary Ports in its area of responsibility.

It is recommended that each appropriate Hydrographic Office, or an organisation authorised by it, should determine the spatial limits for applying tidal information where applicable, and the number of tidal stations to be used in modelling. The Hydrographic Offices should be responsible for determining the best methodologies to be used in their areas of responsibility.

Where tidal information is encoded, it must be assessed to a minimum confidence level of 95%, irrespective of the method of application or its source.

##### 3.2.1 Time series data

If it is required to encode times and heights of high and low waters, it must be done using the object class **T\_TIMS**. In addition, where the data is available, a regular time series of tidal heights should also be encoded using this object class.

Geo object: Tide-time series (**T\_TIMS**) (P,A)  
 Attributes: NOBJNM OBJNAM  
TIMEND TIMSTA - specify the period for which the time series is valid.  
T\_ACWL T\_TSVL T\_TINT T\_HWLW STATUS INFORM NINFOM

### 3.2.2 Prediction by harmonic methods

If it is required to encode the parameters for the prediction of tidal heights using harmonic methods, it must be done using the object-class **T\_HMON**. The supplier of parameters should be consulted on how to use this data, and which calculation algorithms to use with the data.

Geo object: Tide-harmonic prediction (**T\_HMON**) (P,A)  
 Attributes: NOBJNM OBJNAM T\_ACWL  
T\_M TOD - 1 - simplified harmonic method of tidal prediction.  
 2 - full harmonic method of tidal prediction.  
T\_VAHC STATUS INFORM NINFOM

### 3.2.3 Prediction by non-harmonic methods

If it is required to encode the parameters for the prediction of tidal heights using time and height differences, it must be done using the object class **T\_NHMN**.

The reference port to be used for these predictions must be identified using a collection object **C\_ASSO** between the tidal parameter object **T\_TIMS** or **T\_HMON** of the reference port, and the tidal parameter object **T\_NHMN** of the secondary port. If the reference port is not located within the data set or exchange set, then its tidal parameters should be supplied as a geo object with no geometry.

Other non-harmonic methods for predicting tidal heights are not currently supported.

Geo object: Tide-non-harmonic prediction (**T\_NHMN**) (P,A)  
 Attributes: NOBJNM OBJNAM T\_ACWL  
T\_M TOD - 3 - time and height differences non-harmonic method.  
T\_THDF STATUS INFORM NINFOM

## 3.3 Tidal stream data (see S-4 – B-407)

### 3.3.1 Tidal stream (flood/ebb) (see S-4 – B-407.4)

If it is required to encode tidal stream information that is limited to flood and ebb directions and/or values, it must be done using the object class **TS\_FEB**.

Geo object: Tidal stream-flood/ebb (**TS\_FEB**) (P,A)  
 Attributes: CAT TS  
CURVEL - maximum rate (during springs).  
 DATEND DATSTA NOBJNM OBJNAM ORIENT PEREND PERSTA  
 INFORM NINFOM

### 3.3.2 Tidal stream time series

If it is required to encode time series data for tidal streams, it must be done using the object class **TS\_TIS**.

Geo object: Tidal stream - time series (**TS\_TIS**) (P,A)  
 Attributes: NOBJNM OBJNAM  
TIMEND TIMSTA - specifies the period for which the time series is valid.  
TS\_TSV T\_TINT STATUS INFORM NINFOM

### 3.3.3 Prediction by harmonic methods

If it is required to encode parameters for the prediction of tidal streams using harmonic methods, it must be done using the object class **TS\_PRH**. The supplier of parameters should be consulted on how to use this data, and which calculation algorithms to use with the data.

Geo object: Tidal steam - harmonic prediction (**TS\_PRH**) (P,A)  
 Attributes: NOBJNM OBJNAM  
T\_MTOD - 1 - simplified harmonic method of tidal prediction.  
 2 - full harmonic method of tidal prediction.  
T\_VAHC STATUS INFORM NINFOM

### 3.3.4 Prediction by non-harmonic methods

If it is required to encode parameters for the prediction of tidal streams using time and rate, it must be done using the object class **TS\_PNH**.

The reference station to be used for these predictions must be identified using a collection object **C\_ASSO** between the stream parameter object **TS\_TIS** or **TS\_PRH** of the reference station, and the stream parameter object **TS\_PNH** of the secondary station. If the reference station is not located within the data set or exchange set, then its tidal stream parameters should be supplied as a geo object with no geometry.

Other non-harmonic methods for predicting tidal stream are not currently supported.

Geo object: Tidal steam - non-harmonic prediction (**TS\_PNH**) (P,A)  
 Attributes: NOBJNM OBJNAM T\_THDF  
T\_MTOD - 3 – time and height differences non-harmonic method.  
 STATUS INFORM NINFOM

### 3.3.5 Tidal stream panels (see S-4 – B-407.3)

If it is required to encode the information generally shown on paper charts as a tidal stream panel and stations, it must be done using the object class **TS\_PAD**.

Tidal stream values encoded in this way should be mean spring rates, i.e. the tidal stream rates associated with a tidal range which is defined as the difference in height between MHWS and MLWS.

Geo object: Tidal steam panel data (**TS\_PAD**) (P,A)  
 Attributes: NOBJNM OBJNAM TS\_TSP INFORM NINFOM

## 3.4 Current data (see S-4 – B-408)

If it is required to encode a non-gravitational current, it must be done using the object class **CURRENT**.

Geo object: Current (**CURRENT**) (P)  
 Attributes: CURVEL DATEND DATSTA NOBJNM OBJNAM ORIENT PEREND  
 PERSTA INFORM NINFOM

## 4 Topography

The use of Global Navigation Satellite Systems (GNSS) as an integral component of ECDIS has raised questions as to the level of topographic detail that is required in ENCs to enable safe navigation using ECDIS. When determining the topographic information necessary for inclusion in ENC, all operational conditions of vessels must be taken into consideration, including the potential for corruption or failure of a vessel's GNSS reception. Such a failure would require the mariner to navigate by fixing their position using traditional methods, necessitating a sufficient level of depiction of topographic detail in the ENC to facilitate navigation using these methods, appropriate to the Navigational Purpose of the ENC.

In addition, mariners will continue to use visual or radar fixing as an independent method of confirming the position of their vessel as shown on the ECDIS, in order to gain a greater level of confidence in terms of their navigation.

Encoders are advised, therefore, that when determining the level of depiction of topographic detail required for ENC, this should be done in accordance with the principles described in S-4 section B-300 – Topography.

### 4.1 Land area

Land areas that are never covered by water must be encoded using the object class **LNDARE**.

Rivers, canals, lakes, basins and docks, which are not navigable at compilation scale, must be encoded on top of **LNDARE** or **UNSARE** objects (see clause 5.4.8).

**LNDARE** objects of type area are part of Group 1.

Geo object: Land area (**LNDARE**) (P,L,A)  
 Attributes: CONDTN OBJNAM NOBJNM STATUS INFORM NINFOM

Remarks:

- If it is required to describe the natural scenery of the land, it must be done using the object class **LNDRGN** (see clause 4.7.1).
- **LNDARE** is usually of type area; it may, however, be of type point (e.g. islet, rock that does not cover), or of type line (e.g. islet, offshore bar, isthmus).

### 4.2 Vertical measurements (see S-4 – B-302 and B-303)

#### 4.2.1 Vertical datum

See clause 2.1.2.

#### 4.2.2 Heights and elevations

If it is required to encode the altitude of natural features (e.g. hills, coastlines, slopes), with the exception of trees, it must be done using the attribute **ELEVAT** (figure 1 - a).

For artificial features (e.g. landmarks, buildings) or trees:

- If it is required to encode the altitude of the ground level at the base of the object, it must be done using **ELEVAT** (figure 1 - b).
- If it is required to encode the altitude of the highest point of the object, it must be done using the attribute **HEIGHT** (figure 1 - c).
- If it is required to encode the height of the object above ground level, it must be done using the attribute **VERLEN** (figure 1 - d).

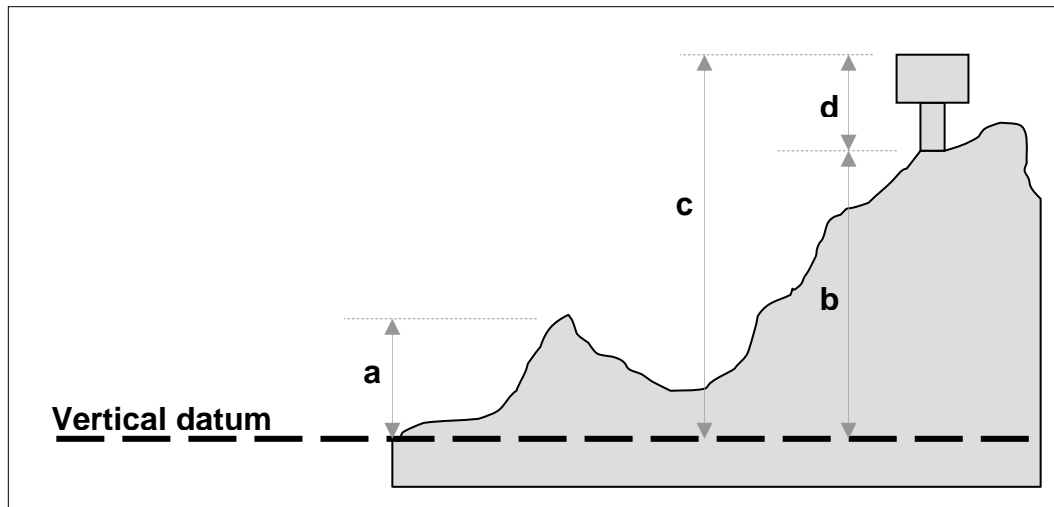

Figure 1 – Heights and elevations

### 4.3 Control points (see S-4 – B-304 to B-306)

If it is required to encode a control point, it must be done using the object class **CTRPNT**.

Geo object: Control point (**CTRPNT**) (P)  
 Attributes: CATCTR DATEND DATSTA ELEVAT NOBJNM OBJNAM VERACC  
 VERDAT INFORM NINFOM

### 4.4 Distance marks (see S-4 – B-307)

If it is required to encode a distance mark, it must be done using the object class **DISMAR**.

Geo object: Distance mark (**DISMAR**) (P)  
 Attributes: CATDIS DATEND DATSTA NOBJNM OBJNAM  
 INFORM - the value of distance with its unit of measurement.  
 NINFOM

### 4.5 Coastline

In all cases the coastline must be encoded using either **COALNE** or **SLCONS** (line or area) objects. These features form the border of the land area (**LNDARE**) object.

Natural sections of coastlines, lakeshores and river banks should be encoded as **COALNE**, whereas artificial sections of coastlines, lake shores, river banks, canal banks and basin borders should be encoded as **SLCONS**. The exception to this general rule is when a lake, river, canal, or basin is not navigable at the compilation scale, in which case the boundaries must not be encoded as **COALNE** or **SLCONS** (see clauses 4.6.6.3, 4.6.6.5, 4.7.6, 4.7.8, 4.8.1).

#### 4.5.1 Natural coastline (see S-4 – B-312)

Geo object: Coastline (**COALNE**) (L)  
 Attributes: CATCOA COLOUR CONRAD CONVIS ELEVAT NOBJNM OBJNAM  
 VERACC VERDAT INFORM NINFOM

Spatial objects associated with unsurveyed coastlines (see S-4 – B-311) should be encoded using spatial attribute **QUAPOS = 2** (unsurveyed).

If it is required to encode a description of the nature of the coastline, it must be done using the attribute **CATCOA**. Other area objects may be used to describe the land region adjacent to the coastline (see clause 4.7).

**4.5.2 Artificial coastline (see S-4 – B-313; B-321 to B-322 and B-324)**

Geo object:	Shoreline construction ( <b>SLCONS</b> )							(P,L,A)
Attributes:	CATSLC	COLOUR	COLPAT	CONDTN	CONRAD	CONVIS	DATEND	
	DATSTA	HEIGHT						
	HORACC - applies to HORCLR.							
	HORCLR	HORLEN	HORWID	NATCON	NOBJNM	OBJNAM	STATUS	
	VERACC	VERDAT	VERLEN	WATLEV	INFORM	NINFOM		

Figure 2 represents a shoreline construction such as a mole, including a berthing facility (INT1 - F12), with a relatively flat top (*abcdlmna*), and sloping sides partly above high water (*nmldefgn*) and partly intertidal (*dopqhgfed*).

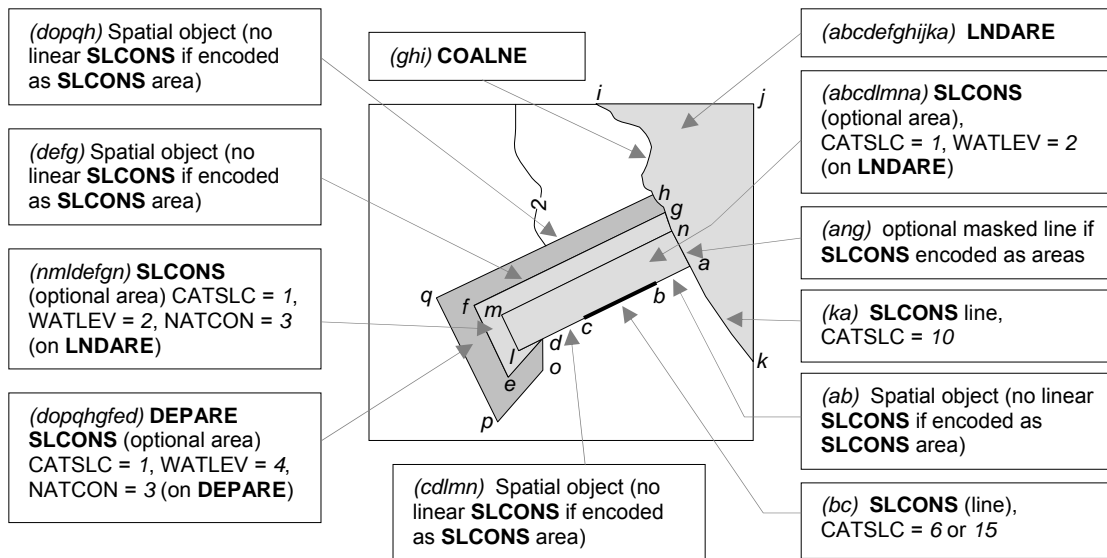

Figure 2 – Shoreline constructions

Remarks:

- Each of the three parts of the shoreline construction may be encoded as separate **SLCONS** objects of type area, and the masked line (*ang*) is optional. Alternatively, the boundaries of the shoreline construction may be encoded as **SLCONS** objects of type line, and, if part of the **SLCONS** boundary has a different characteristic (e.g. (*bc*) attribute CATSLC = 6 or 15), it should be encoded as a separate **SLCONS** object of type line.
- In this example, the shoreline construction area above the high water line must also be covered by a **LNDARE** object of type area, and the intertidal shoreline construction area must also be covered by a **DEPARE** object of type area.
- **SLCONS** objects should be broken into their constituent parts, and categorised using attributes such as CATSLC and WATLEV as indicated on the source.
- If the presence of an object is only indicated on the source by a textual reference, without a clear symbol (e.g. “pier”, “groyne”, “post”), it should be encoded using a **CTNARE** object (see clause 6.6) with the textual reference encoded using the attribute INFORM.
- Intertidal or submerged artificial rock walls, such as training walls that are not attached to the shoreline, should be encoded using the appropriate value for CATSLC, and WATLEV = 3 (always under water/submerged) or WATLEV = 4 (covers and uncovers).
- The S-57 definition for shoreline construction is too specific, and it has been recognised that some shoreline constructions (e.g. breakwaters) may be afloat. Additionally, instances exist where a training wall is always under water/submerged (WATLEV = 3). It therefore does not exist “between the water and the land”. The feature could also exist some distance from the coastline, not forming part of the coastline and not fitting the definition for **COALNE**. Such a feature would be a man made structure and should be considered to fit the definition of a training wall. The definition for shoreline construction should therefore be interpreted as follows: “A fixed artificial

structure in the water and/or adjoining the land. It may also refer to training walls, which are not necessarily connected to, nor form part of, the shoreline.”

## 4.6 Harbour installations

### 4.6.1 Harbour facilities (see S-4 – B-320 and B-321.5)

If it is required to encode a harbour facility, it must be done using the object class **HRBFAC**.

Geo object: Harbour facility (**HRBFAC**) (P,A)  
 Attributes: CATHAF CONDTN DATEND DATSTA NATCON NOBJNM OBJNAM  
 PEREND PERSTA STATUS INFORM NINFOM

Remarks:

- Depending on the navigational purpose, harbour facilities are defined by: an area including docks, basins, and dockside equipment; or a point.
- If it is required to encode a terminal with facilities to load/unload or store shipping containers, this should be done using **HRBFAC** with attribute CATHAF = 10 (container terminal).
- If it is required to encode a covered terminal into which ships can go, this should be done using **HRBFAC** with the purpose of the terminal defined by CATHAF. The roof of the terminal may be encoded using the attribute NATCON, and the maximum height and/or draught of vessels able to use the terminal encoded using the attribute INFORM. Alternatively, the roofed structure may be encoded using a **BUISGL** object (see clause 4.8.15).

### 4.6.2 Berths (see S-4 – B-321, B-321.6-9 and B-410.1)

If it is required to encode a berth, it must be done using the object class **BERTHS**.

Geo object: Berth (**BERTHS**) (P,L,A)  
 Attributes: DATEND DATSTA  
 DRVAL1 - minimum depth at the berth.  
 NOBJNM OBJNAM - name or number of the berth.  
 PEREND PERSTA QUASOU SOUACC STATUS ~~VERDAT~~  
 INFORM - maximum draft permitted at the berth (e.g. *Maximum draft permitted = 14 metres*).  
 NINFOM

Remarks:

- The berth encodes the named place where a vessel can be moored adjacent to a shoreline construction. The shoreline construction itself should be encoded using the object class **SLCONS** (see clause 4.5.2).
- Landing places for boats should be encoded as small craft facilities (see clause 4.6.5).

### 4.6.3 Harbour offices (see S-4 – B-325)

If it is required to encode a harbour office, it must be done using the object class **BUISGL** (see clause 4.8.15), with the attribute FUNCTN taking at least one of the values:

- 2 - harbour-master's office
- 3 - custom office
- 4 - health office
- 11 - pilot office

### 4.6.4 Checkpoints

If it is required to encode a checkpoint, it must be done using the object class **CHKPNT**.

Geo object: Checkpoint (**CHKPNT**) (P,A)  
 Attributes: CATCHP NOBJNM OBJNAM STATUS INFORM NINFOM



## Remarks:

- The **CHKPNT** must only be used to encode the function. In addition, if it is required to encode a physical object (e.g. building), it must be done using an appropriate object class (e.g. **BUISGL**, **LNDMRK**).

**4.6.5 Small craft facilities (see S-4 –B-320.2; B-321.8 and B-432.5)**

If it is required to encode a small craft facility, it must be done using the object class **SMCFAC**.

Geo object: Small craft facility (**SMCFAC**) (P,A)  
 Attributes: CATSCF NOBJNM OBJNAM PEREND PERSTA STATUS INFORM  
 NINFOM

## Remarks:

- The **SMCFAC** must only be used to encode the function. In addition, if it is required to encode a physical object (e.g. building, mooring buoy), it must be done using an appropriate object class (e.g. **BUISGL**, **MORFAC**).
- Due to possible ECDIS display issues **SMCFAC** objects of type area should only be encoded on **LNDARE**, **SLCONS** or **PONTON** objects of type area. If it is required to encode a small craft facility in the water, this should be done using the point primitive encoded on the associated physical object (noting that **SMCFAC** of type point do not display in ECDIS).
- The S-57 definition for attribute value CATSCF = 3 (boat hoist) should be interpreted as including all types of boat.

**4.6.6 Docks****4.6.6.1 Dry docks (see S-4 – B-326.1)**

If it is required to encode a dry dock, it must be done using the object class **DRYDOC**.

Geo object: Dry dock (**DRYDOC**) (A)  
 Attributes: CONDTN  
 DRVAL1 - minimum depth in the dock when the gate is open.  
 HORACC - applies only to HORCLR.  
 HORCLR HORLEN HORWID NOBJNM OBJNAM QUASOU SOUACC  
 STATUS ~~VERDAT~~  
 INFORM - maximum draft permitted in the dock (e.g. *Maximum draft permitted = 6 metres*).  
 NINFOM

## Remarks:

- A dry dock must also be covered by a **LNDARE** object. The boundary of a dry dock must not be encoded as a separate object (**COALNE** or **SLCONS**), except for the gate object (**GATCON**), which may be encoded.

**4.6.6.2 Floating docks (see S-4 – B-326.2)**

If it is required to encode a floating dock, it must be done using the object class **FLODOC**.

Geo object: Floating dock (**FLODOC**) (L,A)  
 Attributes: COLOUR COLPAT CONDTN CONRAD CONVIS DATEND DATSTA  
 DRVAL1  
 HORACC - applies only to HORCLR.  
 HORCLR HORLEN HORWID LIFCAP NOBJNM OBJNAM STATUS  
~~VERACC~~ ~~VERDAT~~ ~~VERLEN~~  
 INFORM - maximum draft permitted in the dock (e.g. *Maximum draft permitted = 6 metres*).  
 NINFOM

## Remarks:

- **FLODOC** of type area are part of Group 1. Note that the attributes DATEND and DATSTA should not be populated for any Group 1 object classes. A **CTNARE** object (see clause 6.6) may be used to indicate to the mariner that the presence of a floating dock of type area is temporary or periodic, using attributes INFORM or TXTDSC (see clause 2.6.1d).

**4.6.6.3 Tidal and non-tidal basins (see S-4 – B-326.3 and B-326.4)**

Geo object: Dock area (**DOCARE**) (A)  
 Attributes: CATDOC CONDTN DATEND DATSTA  
 HORACC - applies only to HORCLR.  
 HORCLR - size of the entrance.  
 NOBJNM OBJNAM STATUS INFORM NINFOM

## Remarks:

- If the dock is navigable at compilation scale, it must be encoded using the object classes **DEPARE** or **DRGARE** (see clause 5.4.8), and the geo objects making up the dock limits must be encoded using appropriate object classes such as **COALNE**, **SLCONS** or **GATCON**. The dock must not be encoded as **DOCARE**. If it is required to encode the name of the dock, it must be done using the object class **SEAARE**.
- If it is required to encode a dock which is not navigable at compilation scale, it must be done using the object class **DOCARE**, covered by a **LNDARE** or **UNSARE** object. The name of the dock should be encoded using the attribute OBJNAM on the **DOCARE**. The boundary of a dock must not be encoded as a separate object (e.g. **COALNE**, **SLCONS**), except for the gate object (**GATCON**), which may be encoded.
- In a non-tidal basin, depths may refer to a sounding datum different to that in open waters. If this area is navigable at the compilation scale, the value of this datum must be encoded using the meta object **M\_SDAT**, with attribute VERDAT = 24 (local datum).
- In reality, smaller dock areas may be included in major dock areas, with different names or characteristics. To encode this fact, dock areas (**DOCARE**) and/or sea areas (**SEAARE**) may overlap.

**4.6.6.4 Gates (see S-4 – B-326.5 to B-326.7)**

If it is required to encode a gate that controls the flow of water, it must be done using the object class **GATCON**.

Geo object: Gate (**GATCON**) (P,L,A)  
 Attributes: CATGAT CONDTN  
 DRVAL1 - minimum depth over the sill.  
 HORACC - applies only to HORCLR.  
 HORCLR NATCON NOBJNM OBJNAM QUASOU SOUACC STATUS  
 VERACC - applies only to VERCLR.  
 VERCLR  
 VERDAT - applies only to VERCLR (not DRVAL1).  
 INFORM NINFOM

**GATCON** of type area must also be covered by a **DEPARE** or **LNDARE** object.

**4.6.6.5 Locks**

If it is required to encode a lock basin, it must be done using the object class **LOKBSN**.

Geo object: Lock basin (**LOKBSN**) (A)  
 Attributes: DATEND DATSTA  
 HORACC - applies only to HORCLR.  
 HORCLR HORLEN HORWID NOBJNM OBJNAM STATUS INFORM  
 NINFOM

## Remarks:

- If the lock is navigable at compilation scale, it must be encoded using the object classes **DEPARE** or **DRGARE** (see clause 5.4.8), and the geo objects making up the limits of the lock must be encoded using appropriate object classes such as **COALNE**, **SLCONS** or **GATCON**. The lock must not be encoded as **LOKBSN**. If it is required to encode the name of the lock, it must be done using the object class **SEAARE**.
- If it is required to encode a lock that is not navigable at compilation scale, it must be done using **LOKBSN** covered by a **LNDARE** or **UNSARE** object. The name of the lock should be encoded using the attribute OBJNAM on the **LOKBSN** object.
- The gates should be encoded as a **GATCON** object with attribute CATGAT = 4 (lock gate) or 3 (caisson). At small scale, a lock may be encoded using **GATCON** only, without using **LOKBSN**.

**4.6.6.6 Gridirons (see S-4 – B-326.8)**

If it is required to encode a gridiron, it must be done using the object class **GRIDRN**.

Geo object: Gridiron (**GRIDRN**) (P,A)  
 Attributes: ~~HORACC~~ HORLEN HORWID NATCON NOBJNM OBJNAM STATUS  
~~VERACC~~ VERLEN WATLEV INFORM NINFOM

## Remarks:

- **GRIDRN** objects of type point do not display in ECDIS. Encoders wishing to display these objects in ECDIS must consider alternate encoding options (e.g. using **OBSTRN**, **SLCONS**, or encoding a small area-type **GRIDRN** object).

**4.6.7 Mooring / warping facilities and pontoons****4.6.7.1 Mooring / warping facilities (see S-4 – B-327)**

If it is required to encode a mooring/warping facility, it must be done using the object class **MORFAC**.

Geo object: Mooring / warping facility (**MORFAC**) (P,L,A)  
 Attributes: BOYSHP - used only if CATMOR = 7.  
~~CATMOR~~ COLOUR COLPAT CONDTN CONRAD CONVIS DATEND  
 DATSTA HEIGHT NATCON NOBJNM OBJNAM PEREND PERSTA  
 STATUS ~~VERACC~~ ~~VERDAT~~ VERLEN WATLEV INFORM NINFOM

## Remarks:

- If it is required to encode a pile or post that is used as a mooring post, it must be done using **MORFAC**, with attribute CATMOR = 5 (pile or post). If the pile or post is not used as a mooring post, see clause 4.6.7.2.
- Stumps of mooring posts dangerous to navigation must be encoded using the object class **OBSTRN**, with attribute CATOBS = 1 (snag/stump). If such stumps are not dangerous to navigation, they must be encoded using **MORFAC**, with attributes CATMOR = 5 (pile or post) and CONDTN = 2 (ruined).
- A **MORFAC** object of type area, with attribute WATLEV = 1, 2 or 6 must also be covered by a **LNDARE** object.

**4.6.7.2 Piles**

If it is required to encode a pile or post that is not used as a mooring/warping facility, it must be done using the object class **PILPNT**.

Geo object: Pile (**PILPNT**) (P)  
 Attributes: CATPLE COLOUR COLPAT CONDTN CONVIS DATEND DATSTA  
 HEIGHT NOBJNM OBJNAM ~~VERACC~~ ~~VERDAT~~ VERLEN INFORM  
 NINFOM

## Remarks:

- Stumps of piles or posts that are dangerous to navigation must be encoded using **OBSTRN** objects, with attribute CATOBS = 1 (snag/stump), and must not be encoded using **PILPNT**.

- See clause 4.6.7.1 for details of how to encode a pile or post that is used as a mooring/warping facility.
- The attribute CONRAD is not an allowable attribute for **PILPNT**. If it is required to encode a pile carrying a radar reflector, it should be done by encoding a **BCNSPP** object (see clause 12.3.1), with attribute CONRAD = 3 (radar conspicuous(has radar reflector)), to conform to clause 12.12 (2<sup>nd</sup> Remarks bullet point).

#### 4.6.7.3 Pontoons (see S-4 – B-324.3)

If it is required to encode a pontoon, it must be done using the object class **PONTON**.

Geo object: Pontoon (**PONTON**) (L,A)  
 Attributes: CONDTN CONRAD CONVIS DATEND DATSTA NATCON NOBJNM  
 OBJNAM PEREND PERSTA STATUS ~~VERACC~~ VERLEN INFORM  
 NINFOM

Remarks:

- The current S-57 definition for pontoon implies that a pontoon can only be a landing, pier head or bridge support. This is considered to be too restrictive and this definition should be treated as indicative only. Other appropriate floating structures, not included in the definition, may therefore be encoded using **PONTON**.
- **PONTON** objects of type area are part of Group 1. Note that the attributes PEREND, PERSTA, DATEND and DATSTA should not be populated for any Group 1 object classes. A **CTNARE** object (see clause 6.6) may be used to indicate to the mariner that the presence of a pontoon of type area is temporary or periodic, using the attributes INFORM or TXTDSC (see clause 2.6.1d).

#### 4.6.8 Hulks

If it is required to encode a hulk, it must be done using the object class **HULKES**.

Geo object: Hulk (**HULKES**) (P,A)  
 Attributes: CATHLK COLOUR COLPAT CONDTN CONRAD CONVIS ~~HORACC~~  
 HORLEN HORWID NOBJNM OBJNAM ~~VERACC~~ VERLEN INFORM  
 NINFOM

Remarks:

- **HULKES** objects of type area are part of Group 1.

#### 4.6.9 Dockside buildings and structures

##### 4.6.9.1 Transit sheds and warehouses (see S-4 – B-328.1)

If it is required to encode a transit shed or warehouse, it must be done using a **BUISGL** object (see clause 4.8.15), with attributes FUNCTN = 15 (transit shed/warehouse), and if it is required, OBJNAM = name or number of the shed.

##### 4.6.9.2 Timber yards (see S-4 – B-328.2)

If it is required to encode a timber yard, it must be done using a **PRDARE** object (see clause 4.8.13), with attribute CATPRA = 6 (timber yard).

##### 4.6.9.3 Cranes (see S-4 – B-328.3)

If it is required to encode a crane, it must be done using the object class **CRANES**.

Geo object: Crane (**CRANES**) (P,A)  
 Attributes: CATCRN COLOUR COLPAT CONDTN CONRAD CONVIS HEIGHT  
 LIFCAP NOBJNM OBJNAM  
 ORIENT - angular distance from true north to the axis of the crane's jib (generally perpendicular to the wharf).

RADIUS STATUS  
 VERACC - applies only to VERCLR (not HEIGHT).  
 VERCLR  
 VERDAT - applies only to VERCLR (not HEIGHT).  
 VERLEN INFORM NINFOM

Remarks:

- The position of a sheerleg or a travelling crane is defined as its resting position. If it is required to encode the track, it must be done using the object class **RAILWY** (see clause 4.8.2).
- If it is required to encode an offshore crane, an ECDIS Base Display object (e.g. **PILPNT**, **LNDARE**) must also be encoded coincident to ensure the feature is always displayed on the ECDIS. Where fitted, lights should be encoded as described in clause 12.8, with the **CRANES** being used as the structure object for the **LIGHTS** equipment object(s) (see clause 12.1.1).

#### 4.6.10 Works in progress and projected (see S-4 – B-329)

Features that are under construction or projected should be encoded in the same way as existing features (e.g. using **LNDARE**, **SLCONS**, **DRYDOC**, **PIPSOL** objects), with the attributes:

CONDTN - 1 - under construction  
 3 - under reclamation  
 5 - planned construction  
 SORDAT - year or date of the information

The coastline existing before the beginning of the works should remain encoded as a **COALNE** or **SLCONS** object until the completion of the works.

## 4.7 Natural features (see S-4 – B-350)

### 4.7.1 Natural sceneries

If it is required to describe the natural scenery of the land, or to give the geographic name of an area on land, it should be encoded using the object class **LNDRGN**.

Geo object: Land region (**LNDRGN**) (P,A)  
 Attributes: CATLND NATQUA NATSUR NOBJNM OBJNAM WATLEV INFORM  
 NINFOM

Remarks:

- This object class has a use similar to that of the object class **SEAARE** (see clause 8), but for the land.
- A **LNDRGN** area should be bounded, if possible, by existing lines used by other objects (e.g. **COALNE**). If necessary, however, this area may be bounded by other lines created to close the area, or to describe a new area.
- Where an encoded **LNDARE** (see clause 4.1) has the name of the area populated on the attribute **OBJNAM**, it is not required to encode a **LNDRGN** object coincident in order to have the name display in the ECDIS.
- For capes, points, peninsulas and other types of **LNDRGN** where there is no specific value for the attribute **CATLND**, the generic term "Cape", "Point", "Peninsula", etc may be included on the attributes **OBJNAM** and **NOBJNM**, unless the name has been populated on an underlying **LNDARE**, in which case **LNDRGN** should not be encoded.
- **LNDRGN** objects of type area may overlap.
- A **LNDRGN** object of type area must be covered by objects from Group 1 (**LNDARE**, **DEPARE**, **UNSARE** etc).

### 4.7.2 Height contours, spot heights (see S-4 – B-351)

If it is required to encode a height contour or spot height, it must be done using the object class **LNDELV**.

Geo object: Land elevation (**LNDELV**) (P,L)  
 Attributes: CONVIS ELEVAT NOBJNM OBJNAM ~~VERACC~~ ~~VERDAT~~ INFORM  
 NINFOM

Height contours are associated with line spatial objects, whereas spot heights are associated with point spatial objects.

Spatial objects associated with approximate contours or spot heights should be encoded using the attribute QUAPOS = 4 (approximate).

#### 4.7.3 Marsh (see S-4 – B-312.2)

If it is required to encode a marshy area behind the coastline, it must be done using a **LNDRGN** object, with attribute CATLND = 2 (marsh).

If the seaward edge of a marsh area is coincident with the coastline, the coastline should be encoded as a **COALNE** object, with attribute CATCOA = 8 (marshy shore), and the coastline's spatial object should have the attribute QUAPOS = 4 (approximate) for the visible coastline.

#### 4.7.4 Dunes, sand hills (see S-4 – B-312.3)

If it is required to encode a dune or sand hill, it must be done using the object class **SLOGRD**.

Geo object: Sloping ground (**SLOGRD**) (P,A)  
 Attributes: CATSLO - 3 - dune.  
                   4 - hill.  
                   COLOUR CONRAD CONVIS ~~NATCON~~ ~~NATQUA~~ NATSUR NOBJNM  
                   OBJNAM INFORM NINFOM

If these features are positioned along the coastline, a **COALNE** object must also be created.

If it is required to encode the height of one of these features, a **LNDELV** object must also be created.

Remarks:

- **SLOGRD** objects of type area and having attributes CATSLO ≠ 6 (cliff) and CONRAD ≠ 1 (radar conspicuous); or CATSLO = empty (null) value, do not display in ECDIS. Encoders wishing to display these objects in ECDIS must consider alternate encoding options (e.g. using **LNDMRK**, or encoding a point-type **SLOGRD**).

#### 4.7.5 Cliffs (see S-4 – B-312.1)

If it is required to encode a cliff, it must be done using a **SLOGRD** object (see clause 4.7.4), with attribute CATSLO = 6 (cliff) and / or using the object class **SLOTOP**.

Geo object: Slope topline (**SLOTOP**) (L)  
 Attributes: CATSLO - 6 - cliff.  
                   COLOUR CONRAD CONVIS ELEVAT ~~NATCON~~ ~~NATQUA~~ NATSUR  
                   NOBJNM OBJNAM ~~VERACC~~ ~~VERDAT~~ INFORM NINFOM

For example:

**SLOGRD** may be used at large scale to indicate the horizontal extent of the cliff.

**SLOTOP** should be used on its own to encode cliffs at small scale, or in conjunction with **SLOGRD** to indicate the crest line of the cliff:

- when it is useful to know its elevation;
- to encode a cliff on land distant from the coastline.

Remarks:

- When the cliff is coincident with the coastline, a **COALNE** object, with attribute CATCOA = 1 (steep coast) should be encoded, and there should be no **SLOTOP** or **SLOGRD** encoded.

#### 4.7.6 Rivers (see S-4 – B-353)

If it is required to encode a river, it must be done using the object class **RIVERS**.

Geo object: River (**RIVERS**) (L,A)  
 Attributes: NOBJNM OBJNAM  
 STATUS - 5 - intermittent.  
 INFORM NINFOM

Remarks:

- If the river is navigable at compilation scale, it must be encoded using the object classes **DEPARE** or **DRGARE** (see clause 5.4.8), and the river banks must be encoded using the object classes **COALNE** or **SLCONS**. The river must not be encoded as a **RIVERS** object. If it is required to encode the name of the river, it must be done using a **SEAARE** object with attribute CATSEA = 53 (river).
- If it is required to encode a river that is not navigable at compilation scale, it must be done using **RIVERS**, covered by a **LNDARE** or **UNSARE** object. The name of the river should be encoded using the attribute OBJNAM on the **RIVERS** object.
- Some dry riverbeds, known as Wadis, may be prominent topographic features. If it is required to encode a Wadi, it should be done using a **LNDRGN** object (see clause 4.7.1), with the name of the Wadi encoded using the attribute OBJNAM.
- Use of the object class **RIVBNK** is prohibited.

#### 4.7.7 Rapids, waterfalls (see S-4 – B-353.5)

##### 4.7.7.1 Rapids

If it is required to encode rapids within a river, it must be done using the object class **RAPIDS**.

Geo object: Rapids (**RAPIDS**) (P,L,A)  
 Attributes: NOBJNM OBJNAM ~~VERACC~~ VERLEN INFORM NINFOM

The area covered by rapids must also be covered by a **RIVERS** object, and a **LNDARE** or **UNSARE** object.

Remarks:

- **RAPIDS** objects of type point do not display in ECDIS. Encoders wishing to display these objects in ECDIS must consider alternate encoding options (e.g. using **LNDMRK**, or encoding a short line-type **RAPIDS** object).

##### 4.7.7.2 Waterfalls

If it is required to encode a waterfall within a river, it must be done using the object class **WATFAL**.

Geo object: Waterfall (**WATFAL**) (P,L)  
 Attributes: CONVIS NOBJNM OBJNAM ~~VERACC~~ VERLEN INFORM NINFOM

The area covered by a waterfall must also be covered by a **RIVERS** object, and a **LNDARE** or **UNSARE** object.

Remarks:

- **WATFAL** objects of type point do not display in ECDIS. Encoders wishing to display these objects in ECDIS must consider alternate encoding options (e.g. using **LNDMRK**, or encoding a short line-type **WATFAL** object).

#### 4.7.8 Lakes (see S-4 – B-353.6)

If it is required to encode a lake, it must be done using the object class **LAKARE**.

Geo object: Lake (**LAKARE**) (A)  
 Attributes: ELEVAT NOBJNM OBJNAM ~~VERACC~~ ~~VERDAT~~ INFORM NINFOM

Remarks:

- If the lake is navigable at compilation scale, it must be encoded using the object classes **DEPARE** or **DRGARE** (see clause 5.4.8), and the lake shore must be encoded using the object classes **COALNE** or **SLCONS**. The lake must not be encoded as a **LAKARE** object. If it is required to

encode the name of the lake, it must be done using a **SEAARE** object, with attribute CATSEA = 52 (lake).

- If it is required to encode a lake that is not navigable at compilation scale, it must be done using **LAKARE**, covered by a **LNDARE** or **UNSARE** object. The name of the lake should be encoded using the attribute OBJNAM on the **LAKARE** object.
- Use of the object class **LAKSHR** is prohibited.

#### 4.7.9 Salt pans (see S-4 – B-353.7)

If it is required to encode a saltpan area, it must be done using a **LNDRGN** object, with attribute CATLND = 15 (salt pan) covered by a **LNDARE** object (i.e. the saltpan does not form a hole in the land area).

If the seaward edge of an encoded saltpan area is coincident with the coastline, it should be encoded using a **COALNE** object, with attribute CATCOA = 2 (flat coast).

#### 4.7.10 Glaciers (see S-4 – B-353.8)

If it is required to encode the portion of a glacier that is on land, it must be done using an **ICEARE** object, with attribute CATICE = 5 (glacier) covered by a **LNDARE** object (i.e. the glacier does not form a hole in the land area).

If the seaward edge of an encoded glacier is coincident with the coastline, this edge should be encoded using a **COALNE** object, with attribute CATCOA = 6 (glacier (seaward end)).

**ICEARE** objects that are located in the sea must be covered by a **LNDARE** or **UNSARE** object, if the depth of water beneath them is unknown, or covered by a **DEPARE** object, if the depth is known.

#### 4.7.11 Vegetation (see S-4 – B-312.4, B-352.4 and B-354)

If it is required to encode vegetation, it must be done using the object class **VEGATN**.

Geo object: Vegetation (**VEGATN**) (P,L,A)  
 Attributes: CATVEG CONVIS ELEVAT  
 HEIGHT - approximate altitude of the highest point of the top of the vegetation.  
 NOBJNM OBJNAM ~~VERACC~~ ~~VERDAT~~ VERLEN INFORM NINFOM

If it is required to encode an isolated tree used as a landmark, it must be done using a **VEGATN** object, with attribute CATVEG = 13 to 21.

If it is required to encode a mangrove area, it must be done using a **VEGATN** object, with CATVEG = 7 (mangroves).

The seaward edge of an encoded mangrove area should be encoded using a **COALNE** object, with attribute CATCOA = 7 (mangrove), and the mangrove area's spatial object should have the attribute QUAPOS = 4 (approximate).

Remarks:

- **VEGATN** objects of type point or area and having attribute CATVEG = 1 (grass), 10 (mixed crops), 11 (reed), 12 (moss) or empty (null) value do not display in ECDIS. Encoders wishing to display these objects in ECDIS must consider alternate encoding options (e.g. using **LNDMRK**, or encoding a short line-type **VEGATN** object).
- Where the source indicates that a mangrove area is in the intertidal area, a **VEGATN** object, with attribute CATVEG = 7 (mangroves) should be encoded on top of the intertidal area (**DEPARE** with attributes DRVAL1 = -H and DRVAL2 = 0 – see clause 5.4). The seaward edge of the mangrove area should be encoded using a **COALNE** object, with attribute CATCOA = 7 (mangrove), and the corresponding spatial edge(s) should have the spatial attribute QUAPOS = 4 (approximate). The landward edge of the mangrove area should be encoded as **COALNE**, having no value populated for CATCOA and no value for QUAPOS on the related spatial edge(s). Where this guidance has been followed, S-58 ENC validation Errors/Warnings related to this encoding should be ignored.



#### 4.7.12 Lava flow (see S-4 – B-355)

If it is required to encode a lava flow, it must be done using a **LNDRGN** object, with attribute **CATLND = 14** (lava flow).

### 4.8 Artificial features

#### 4.8.1 Canals (see S-4 – B-361)

If it is required to encode a canal, it must be done using the object class **CANALS**.

Geo object: Canal (**CANALS**) (L,A)  
 Attributes: CATCAN CONDTN DATEND DATSTA  
 HORACC - applies only to HORCLR.  
 HORCLR HORWID NOBJNM OBJNAM STATUS INFORM NINFOM

Remarks:

- If the canal is navigable at compilation scale, it must be encoded using the object classes **DEPARE** or **DRGARE** (see clause 5.4.8), and the canal banks must be encoded using the object classes **COALNE** or **SLCONS**. The canal must not be encoded as a **CANALS** object. If it is required to encode the name of the canal, it must be done using a **SEAARE** object, with attribute **CATSEA = 51** (canal).
- If it is required to encode a canal that is not navigable at compilation scale, it must be done using **CANALS**, covered by a **LNDARE** or **UNSARE** object. The name of the canal should be encoded using the attribute **OBJNAM** on the **CANALS** object.
- Use of the object class **CANBNK** is prohibited.

#### 4.8.2 Railways (see S-4 – B-362)

If it is required to encode a railway, it must be done using the object class **RAILWY**.

Geo object: Railway (**RAILWY**) (L)  
 Attributes: CONDTN HEIGHT NOBJNM OBJNAM STATUS VERACC INFORM  
 NINFOM

Remarks:

- If it is required to encode a railway station, it must be done using a **BUISGL** object, with attribute **FUNCTN = 8** (railway station).

#### 4.8.3 Tunnels (see S-4 – B-363.1)

If it is required to encode a tunnel, it must be done using the object class **TUNNEL**.

Geo object: Tunnel (**TUNNEL**) (P,L,A)  
 Attributes: ~~BURDEP~~ CONDTN  
 HORACC - applies only to HORCLR.  
 HORCLR NOBJNM OBJNAM  
 VERACC - applies only to VERCLR.  
 VERCLR STATUS INFORM NINFOM

Remarks:

- If there is a waterway inside the tunnel, and the waterway is navigable at compilation scale, it must be encoded as if it were a navigable canal (see clause 4.8.1), using the object classes **DEPARE** or **DRGARE** in conjunction with the **TUNNEL** object. There must be no **LNDARE** object in the area covering the waterway.
- If it is required to encode a waterway inside a tunnel that is not navigable at compilation scale, it must be done using the object class **CANALS** in conjunction with the **TUNNEL** object. A **LNDARE** object must cover the tunnel. The attributes **HORACC**, **HORCLR**, **VERACC** and **VERCLR** must not be encoded on the **TUNNEL** object in this case.

- If it is required to encode a tunnel that has no waterway inside it (but a railway, road etc), only the **TUNNEL** object must be encoded (not the railway or the road), covered by **LNDARE**, **DEPARE**, **DRGARE** or **UNSARE** objects as appropriate.
- **TUNNEL** objects of type point do not display in ECDIS. Encoders wishing to display these objects in ECDIS must consider alternate encoding options (e.g. encoding a short line-type **TUNNEL** object).

#### 4.8.4 Cuttings and embankments (see S-4 – B-363.2 and B-364.1)

If it is required to encode cuttings and embankments, this must be done in the same way as cliffs; using **SLOGRD** and / or **SLOTOP** objects (see clause 4.7.5), with attribute CATSLO = 1 (cutting) or 2 (embankment).

#### 4.8.5 Dams (see S-4 – B-364.2)

If it is required to encode a dam, it must be done using the object class **DAMCON**.

Geo object: Dam (**DAMCON**) (P,L,A)  
 Attributes: CATDAM COLOUR COLPAT CONDTN CONRAD CONVIS DATEND  
 DATSTA HEIGHT NATCON NOBJNM OBJNAM VERACC VERDAT  
 VERLEN INFORM NINFOM

Remarks:

- When a **DAMCON** object is of type area, it must be covered by a **LNDARE** object.
- If it is required to encode a dam whose seaward edge is coincident with the coastline, it must be done using **DAMCON**, with a **SLCONS** object of type line along its seaward edge, with no value populated for attribute CATSLC.
- The geometry of the dam includes any gates. Gates should be encoded as separate **GATCON** objects.
- If it is required to encode a submerged weir, it should be done using an **OBSTRN** object (see clause 6.2.2), with attribute INFORM = *Submerged weir*.
- **DAMCON** objects of type point and having attribute CATDAM = 1 (weir) or 2 (dam) do not display in ECDIS. Encoders wishing to display these objects in ECDIS must consider alternate encoding options (e.g. using **LNDMRK**, **OBSTRN**, **SLCONS**, or encoding a short line-type **DAMCON** object).

#### 4.8.6 Flood barrages (see S-4 – B-326.7)

If it is required to encode the fixed part of a flood barrage, and the flood barrage is inside an area which is navigable at compilation scale, it must be done using a **DAMCON** object, with attribute CATDAM = 3 (flood barrage), and must be covered by a **LNDARE** object. If it is required to encode the opening part of the flood barrage, it must be done using a **GATCON** object, with attribute CATGAT = 2 (flood barrage gate), and must be covered by a **DEPARE** object.

When an encoded flood barrage is inside an area that is not navigable at compilation scale, the gates need not be encoded. In this case, the **DAMCON** object must go all the way across the river or lake.

#### 4.8.7 Dykes (see S-4 – B-313.1)

If it is required to encode a dyke, it must be done using the object class **DYKCON**.

Geo object: Dyke (**DYKCON**) (L,A)  
 Attributes: CONDTN CONRAD DATEND DATSTA HEIGHT NATCON VERACC  
 VERDAT VERLEN INFORM NINFOM

Remarks:

- If it is required to encode a dyke whose seaward edge is coincident with the coastline, it must be done using **DYKCON**, and with a **SLCONS** object of type line along its seaward edge, with no value populated for attribute CATSLC.
- When a **DYKCON** object is of type area, it must be covered by a **LNDARE** object.

- At large compilation scales, the dyke crown (the topline of the dyke) may be encoded as a **SLOTOP** object, with attribute CATSLO = 2 (embankment).

#### 4.8.8 Roads and tracks (see S-4 – B-365)

If it is required to encode a road or track, it must be done using the object class **ROADWY**.

Geo object: Road (**ROADWY**) (P,L,A)  
 Attributes: CATROD CONDTN NATCON NOBJNM OBJNAM STATUS INFORM  
 NINFOM

Remarks:

- Road crossings (attribute CATROD = 7) should not be encoded.
- **ROADWY** objects of type point do not display in ECDIS. Encoders wishing to display these objects in ECDIS must consider alternate encoding options (e.g. using **LNDMRK**, **OBSTRN**, **SLCONS**, or encoding a short line-type **ROADWY** object).

#### 4.8.9 Causeways (see S-4 – B-313.3)

If it is required to encode a causeway, it must be done using the object class **CAUSWY**.

Geo object: Causeway (**CAUSWY**) (L,A)  
 Attributes: CONDTN NATCON NOBJNM OBJNAM STATUS WATLEV INFORM  
 NINFOM

#### 4.8.10 Bridges (see S-4 – B-381)

If it is required to encode a bridge, it must be done using the object class **BRIDGE**.

Geo object: Bridge (**BRIDGE**) (P,L,A)  
 Attributes: CATBRG - mandatory over navigable waters.  
 COLOUR COLPAT CONDTN CONRAD CONVIS DATEND DATSTA  
 HORACC - applies only to HORCLR.  
 HORCLR NATCON NOBJNM OBJNAM  
 VERACC - applies only to VERCCL, VERCLR, VERCOP.  
VERCCL - mandatory for opening bridges.  
VERCLR - mandatory for non-opening bridges.  
VERCOP - mandatory for opening bridges with limited clearance.  
 VERDAT - applies only to VERCCL, VERCLR, VERCOP.  
 INFORM NINFOM

Remarks:

- Water under a bridge must be encoded using the object class **DEPCNT** and the object classes **DEPARE**, **DRGARE** or **UNSARE** if the waterway is navigable at compilation scale, or using the object classes **LNDARE** or **UNSARE** if the waterway is not navigable at compilation scale.
- In navigable water, bridge supports must be encoded, where possible, using a **PYLONS** object (see clause 4.8.18), with attribute CATPYL = 4 (bridge/pylon tower) or 5 (bridge pier).
- It is not mandatory to encode roads or railways on bridges.
- The mandatory attributes apply only for bridges encoded over navigable water. In all other cases there are no mandatory attributes.
- **BRIDGE** objects of type point do not display in ECDIS. Encoders wishing to display these objects in ECDIS must consider alternate encoding options (e.g. using **LNDMRK**, **OBSTRN**, **SLCONS**, or encoding a short line-type **BRIDGE** object).

#### 4.8.11 Conveyors (see S-4 – B-382.3)

If it is required to encode a conveyor, it must be done using the object class **CONVYR**.

Geo object: Conveyor (**CONVYR**) (L,A)  
 Attributes: CATCON COLOUR COLPAT CONDTN CONRAD CONVIS DATEND  
 DATSTA HEIGHT LIFCAP NOBJNM OBJNAM PRODC STATUS  
 VERACC - applies only to VERCLR (not HEIGHT).  
 VERCLR - mandatory over navigable waters.  
 VERDAT - applies only to VERCLR (not HEIGHT).  
 VERLEN INFORM NINFOM

#### 4.8.12 Airfields (see S-4 – B-366)

At large scale, an airport should be encoded using a combination of the following objects: **AIRARE** (area), **RUNWAY** (area or line), **BUISGL** (area or point) and **LNDMRK** (area or point). At least one **AIRARE** or **RUNWAY** must be in this set of objects. Where it is necessary to establish a relationship between these objects, they should be associated using the collection object **C\_ASSO** (see clause 15).

At small scale, an airport should be encoded as an **AIRARE** of type point.

Geo object: Airport / airfield (**AIRARE**) (P,A)  
 Attributes: CATAIR CONDTN CONVIS NOBJNM OBJNAM STATUS INFORM  
 NINFOM

Geo object: Runway (**RUNWAY**) (P,L,A)  
 Attributes: CATRUN CONDTN CONVIS NATCON NOBJNM OBJNAM PEREND  
 PERSTA STATUS INFORM NINFOM

#### Remarks:

- If individual buildings are visually conspicuous, they must be encoded as separate objects.
- Two or more crossing runways may be encoded as one area.
- If it is required to encode the control tower, it must be done using a **LNDMRK** object, with attributes FUNCTN = 39 (control) and CATLMK = 17 (tower). If it is required to encode other buildings, this must be done using the object class **BUISGL**.
- If it is required to encode a seaplane landing area, it must be done using the object class **SPLARE** (see clause 11.12).
- **RUNWAY** objects of type point do not display in ECDIS. Encoders wishing to display these objects in ECDIS must consider alternate encoding options (e.g. using **LNDMRK**, or encoding a short line-type **RUNWAY** object).

#### 4.8.13 Production and storage areas (see S-4 – B-328.2, B-367 and B-374.6)

If it is required to encode production or storage area, it must be done using the object class **PRDARE**.

Geo object: Production / storage area (**PRDARE**) (P,A)  
 Attributes: CATPRA CONDTN CONRAD CONVIS DATEND DATSTA ELEVAT  
 HEIGHT NOBJNM OBJNAM PRODC STATUS VERACC VERDAT  
 VERLEN INFORM NINFOM

#### Remarks:

- If there are individual buildings or equipment objects contained within this area, they should be encoded as separate objects such as **BUISGL**, **CRANES**, **LNDMRK** or **SILTNK** within the **PRDARE** area object.
- If visible from seaward, a quarry face should be encoded in a similar way to a cliff (see clause 4.7.5), with attribute CATSLO = 6 (cliff).
- **PRDARE** objects of type point and having attribute CATPRA = empty (null) value do not display in ECDIS. Encoders wishing to display these objects in ECDIS must consider alternate encoding options (e.g. using **BUISGL**, **LNDMRK**, **OBSTRN**, or populating a value for CATPRA from the enumerate list).

#### 4.8.14 Built-up areas (see S-4 – B-370)

If it is required to encode a built-up area, it must be done using the object class **BUAARE**.

Geo object: Built-up area (**BUAARE**) (P,A)  
 Attributes: CATBUA CONDTN CONRAD CONVIS HEIGHT NOBJNM OBJNAM  
 VERACC VERDAT INFORM NINFOM

## Remarks:

- A built-up area crossed by line objects (e.g. roads, streets, railways) should not be divided into multiple objects, unless separate sections of the built-up area have at least one different attribute value.
- However, for presentation purposes, a built up area of type area crossed by a river or canal of type area must be divided into several objects, with the built-up area objects not overlapping the river or canal object. A built up area of type area should not overlap a lake, dock or lock basin object of type area.
- Use of the object class **SQUARE** is prohibited.
- Several buildings or built-up areas may be referred to by the same settlement, village or town name on the source. In such cases, the individual buildings or built-up areas should be encoded as separate unnamed objects, using the object classes **BUISGL** or **BUAARE**, and additionally, an **ADMARE** object (see clause 14) covering the whole named area should be created with the name encoded using the attribute OBJNAM. The encoded **ADMARE** object should also have the attribute JRSDTN = 3 (national sub-division).

#### 4.8.15 Buildings, landmarks, tanks, silos (see S-4 – B-370 to B-376 and B-378)

If it is required to encode buildings, landmarks, tanks or silos, they must be done using the object classes **BUISGL**, **LNDMRK** or **SILTNK**, depending on their shape and use. The following table describes the way to encode these objects.

Geo object: Building, single (**BUISGL**) (P,A)  
 Attributes: BUISHP COLOUR COLPAT CONDTN CONRAD CONVIS ELEVAT  
 FUNCTN HEIGHT NATCON NOBJNM OBJNAM STATUS VERACC  
 VERDAT VERLEN INFORM NINFOM

Geo object: Landmark (**LNDMRK**) (P,L,A)  
 Attributes: CATLMK COLOUR COLPAT CONDTN CONRAD CONVIS ELEVAT  
 HEIGHT NATCON NOBJNM OBJNAM STATUS FUNCTN VERACC  
 VERDAT VERLEN INFORM NINFOM

Geo object: Silo / tank (**SILTNK**) (P,A)  
 Attributes: BUISHP CATSIL COLOUR COLPAT CONDTN CONRAD CONVIS  
 ELEVAT HEIGHT NATCON NOBJNM OBJNAM PRODC T STATUS  
 VERACC VERDAT VERLEN INFORM NINFOM

In the following table, the symbol '/' indicates that this attribute does not exist for that particular object class. A blank indicates that the encoder may choose a relevant value for the attribute. The table contains the most common examples of coding; other coding combinations are possible.

Feature	INT1	Object-class	FUNCTN	CATLMK	BUISHP	PRODC T	CATSIL
Administrative		<b>BUISGL</b>	18	/		/	/
Bank office		<b>BUISGL</b>	13	/		/	/
Buddhist temple	E16	<b>BUISGL</b>	25	/		/	/
Bus station		<b>BUISGL</b>	42	/		/	/
Cairn	Q100	<b>LNDMRK</b>	/	1	/	/	/
Cemetery	E19	<b>LNDMRK</b>		2	/	/	/
Chapel	E11	<b>BUISGL</b>	21	/		/	/
Chimney	E22	<b>LNDMRK</b>		3		/	
Church	E10.1	<b>BUISGL</b>	20	/		/	/

Feature	INT1	Object-class	FUNCTN	CATLMK	BUIHP	PRODCT	CATSIL
Church dome, Cupola	E10.4	LNDMRK	20	15	/	/	/
Church spire	E10.3	LNDMRK	20	20	/	/	/
Church tower	E10.2	LNDMRK	20	17	/	/	/
Clock tower		LNDMRK	38	17	/	/	/
Column	E24	LNDMRK	/	10	/	/	/
Communication mast		LNDMRK	29	7	/	/	/
Communication tower		LNDMRK	29	17	/	/	/
Control tower		LNDMRK	39	17	/	/	/
Cooling tower		LNDMRK	35	17	/	/	/
Cross, Calvary	E12	LNDMRK		14	/	/	/
Custom office	F61	BUISGL	3	/		/	/
Dish aerial	E31	LNDMRK		4	/	/	/
Dome or cupola, part of a building		LNDMRK		15	/	/	/
Educational facility		BUISGL	19	/		/	/
Factory		BUISGL	16	/		/	/
Flagstaff, Flagpole	E27	LNDMRK		5	/	/	/
Flare stack	E23	LNDMRK		6	/	/	/
Grain elevator		SILTNK	/	/		22	3
Harbour-master's office	F60	BUISGL	2	/		/	/
Headquarters for district control		BUISGL	14	/		/	/
Health office	F62.1	BUISGL	4	/		/	/
Hospital	F62.2	BUISGL	5	/		/	/
Hotel	D6	BUISGL	7	/		/	/
House, Building	D5	BUISGL		/		/	/
Large rock or boulder on land		LNDMRK	/	21	/	/	/
Light house (tower)	P1	LNDMRK	33	17	/	/	/
Light house (other shapes)	P1	BUISGL	33	/		/	/
Lookout station in general		BUISGL	28	/		/	/
Lookout tower		LNDMRK	28	17	/	/	/
Marabout	E18	BUISGL	27	/		/	/
Mast in general		LNDMRK		7	/	/	/
Memorial plaque		LNDMRK		11	/	/	/
Microwave tower		LNDMRK	34	17	/	/	/
Minaret	E17	LNDMRK	26	20	/	/	/
Monument	E24	LNDMRK		9	/	/	/
Mooring mast		LNDMRK	40	7	/	/	/
Mosque	E17	BUISGL	26	/		/	/
Obelisk	E24	LNDMRK	/	12	/	/	/

Feature	INT1	Object-class	FUNCTN	CATLMK	BUIHP	PRODCT	CATSIL
Observation tower		LNDMRK	36	17	/	/	/
Pagoda	E14	BUISGL	23	/		/	/
Pilot lookout	T2	BUISGL	12	/		/	/
Pilot office	T3	BUISGL	11	/		/	/
Police station		BUISGL	9	/		/	/
Post office	F63	BUISGL	6	/		/	/
Power station		BUISGL	17	/		/	/
Radar dome	E30.4	LNDMRK	32	15	/	/	/
Radar mast	E30.1	LNDMRK	32	7	/	/	/
Radar scanner	E30.3	LNDMRK		16	/	/	/
Radar tower	E30.2	LNDMRK	32	17	/	/	/
Radio mast	E28	LNDMRK	31	7	/	/	/
Radio tower	E29	LNDMRK	31	17	/	/	/
Railway station	D13	BUISGL	8	/		/	/
Shinto shrine	E15	BUISGL	24	/		/	/
Silo	E33	SILTNK	/	/			1
Spire, part of a building		LNDMRK		20	/	/	/
Stadium		BUISGL	41	/		/	/
Statue	E24	LNDMRK		13	/	/	/
Tank	E32	SILTNK	/	/			2
Television mast	E28	LNDMRK	30	7	/	/	/
Television tower	E29	LNDMRK	30	17	/	/	/
Temple	E13	BUISGL	22	/		/	/
Timeball tower		LNDMRK	37	17	/	/	/
Tower	E20	LNDMRK		17	/	/	/
Tower, part of a building		LNDMRK		17	/	/	/
Transit shed, Warehouse	F51	BUISGL	15	/		/	/
Water tower	E21	SILTNK	/	/	/	3 or 8	4
Water-police station		BUISGL	10	/		/	/
Windmill	E25	LNDMRK		18	/	/	/
Windmotor on land	E26.1	LNDMRK		19	/	/	/

table 4.1

## Remarks:

- A ruined building or landmark should be encoded in the same way as the feature in good condition, but with attribute CONDTN = 2 (ruined).
- When a building is shown as an area, indicating its true shape, and it is required to encode a prominent feature such as a tower or spire that is part of the structure, two objects must be created (see Figure 3 b):
  - a **BUISGL** object of type area for the main building,
  - a **LNDMRK** object of type point for the prominent feature.

- For covered boathouses, any associated objects should be encoded as they exist in the "real world"; e.g. jetties as **SLCONS**, pontoons as **PONTON**, mooring posts as **MORFAC**. The roofed area may be covered by a **BUISGL** object of type area, with attribute **INFORM** = *Boathouse* or *Boatshed*. If the service being provided by the structure is known, object classes **SMCFAC** (see clause 4.6.5) or **HRBFAC** (see clause 4.6.1) may also be encoded.
- If it is required to encode an offshore building, landmark or silo/tank, an ECDIS Base Display object (e.g. **PILPNT**, **LNDARE**, **PONTON**) must also be encoded coincident to ensure the feature is always displayed on the ECDIS. Where fitted, lights should be encoded as described in clause 12.8, with the **BUISGL**, **LNDMRK** or **SILTNK** being used as the structure object for the **LIGHTS** equipment object(s) (see clause 12.1.1).
- For encoding offshore windmotors, see clause 11.7.4.
- The S-57 definition for attribute value **CATLMK** = 7 (mast) should be interpreted as any relatively tall structure usually held vertical by guy lines.
- The S-57 definition for attribute value **CATLMK** = 17 (tower) should be interpreted as any relatively tall, self-supporting structure.
- Not all landmarks are visually conspicuous. If a feature is visually conspicuous (i.e. it is distinctly and noticeably visible from seaward), the attribute **CONVIS** = 1 (visually conspicuous) must be encoded (see S-4 – B-340).

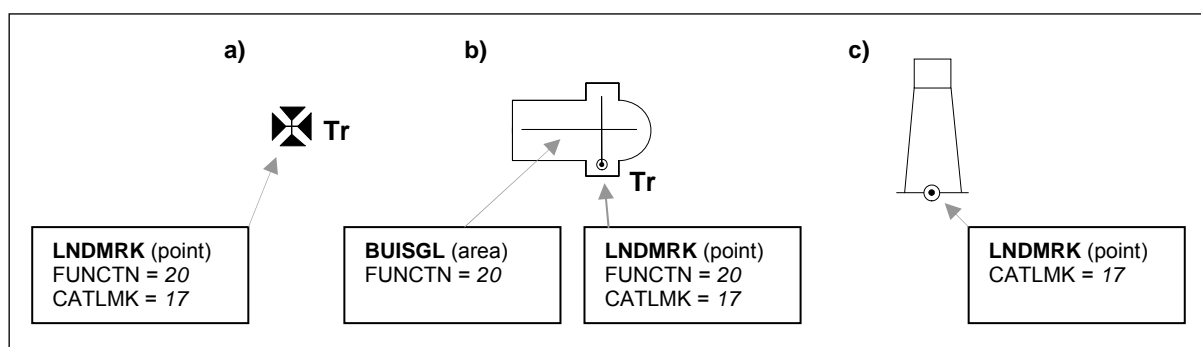

Figure 3 - Landmarks

#### 4.8.16 Fences and walls

If it is required to encode a fence or wall, it must be done using the object class **FNCLNE**.

Geo object:	Fence/wall ( <b>FNCLNE</b> )	(L)					
Attributes:	CATFNC	COLOUR	COLPAT	CONDTN	CONRAD	CONVIS	ELEVAT
	HEIGHT	NATCON	NOBJNM	OBJNAM	STATUS	VERACC	VERDAT
	VERLEN	INFORM	NINFOM				

#### 4.8.17 Fortified structures (see S-4 – B-379)

If it is required to encode a fortified structure, it must be done using the object class **FORSTC**.

Geo object:	Fortified structure ( <b>FORSTC</b> )	(P,L,A)					
Attributes:	CATFOR	CONDTN	CONRAD	CONVIS	HEIGHT	NATCON	NOBJNM
	OBJNAM	VERACC	VERDAT	VERLEN	INFORM	NINFOM	

Remarks:

- A **FORSTC** object with attribute **CATFOR** = 5 (Martello tower) should be used to encode any fortified tower or small round fort used for coastal defence.
- If it is required to encode an offshore fortified structure, an ECDIS Base Display object (e.g. **PILPNT**, **LNDARE**) must also be encoded coincident to ensure the feature is always displayed on the ECDIS. Where fitted, lights should be encoded as described in clause 12.8, with the **FORSTC** being used as the structure object for the **LIGHTS** equipment object(s) (see clause 12.1.1).



#### 4.8.18 Pylons and bridge supports (see S-4 – B-381)

If it is required to encode a pylon or bridge support, it must be done using the object class **PYLONS**.

Geo object: Pylon / bridge support (**PYLONS**) (P,A)  
 Attributes: CATPYL COLOUR COLPAT CONDTN CONRAD CONVIS DATEND  
 DATSTA HEIGHT NATCON NOBJNM OBJNAM ~~VERACC~~ VERDAT  
 VERLEN WATLEV INFORM NINFOM

Remarks:

- A **PYLONS** object of type area with attribute WATLEV = 1, 2 or 6 must be covered by a **LNDARE** object of type area (see clause 4.8.10).

#### 4.8.19 Oil barriers (see S-4 – B-449.2)

If it is required to encode an oil barrier, it must be done using the object class **OILBAR**.

Geo object: Oil barrier (**OILBAR**) (L)  
 Attributes: CATOLB CONDTN DATEND DATSTA NOBJNM OBJNAM STATUS  
 INFORM NINFOM

#### 4.8.20 Views and sketches, viewpoints

If it is required to indicate a drawing or a photograph, the attribute PICREP must be used to indicate the file name (without the path) of the external graphical file. Picture files that form part of the ENC must be in Tagged Image File (TIF) format.

Consideration should be given to the addition of the “information” symbol in some ECDIS display settings where PICREP is populated, which may contribute to ECDIS screen clutter. PICREP should therefore only be populated where the inclusion of the information in ENC, rather than in other nautical publications, is considered important in terms of safety of navigation and protection of the marine environment.

Encoders should also consider, when including a reference to an external graphics file, whether the file is appropriate in terms of:

- Size of the file: Graphics files should be kept to a minimum file size, and should be considered in relation to the maximum allowable size of an ENC data set (5Mb). Therefore, for example, a graphic file of 100Mb should be considered to be inappropriate. Using the following values as a guideline will ensure acceptable size files:

Recommended Resolution:	96 DPI
Minimum Size x,y:	200,200 pixels
Maximum Size x,y:	800,800 pixels
Bit Depth:	8 Bit Indexed Colour
Compression:	LZW
Format:	Tiff 6.0

table 4.2

- Content of the graphic: The information contained in the graphic should supplement, in terms of navigational relevance, the encoding of the associated object. For example, an image of a standard IALA special purpose buoy that duplicates the attribution of the associated **BOYSPP** provides no relevant supplementary information to the mariner (and may be considered to be double encoding), and therefore should not be included.
- Aspect: Graphics should provide perspective relevant to the view of the mariner. For example, an image of the top of a bridge derived from a photograph taken from the top of a bridge tower or nearby building does not provide the mariner with any information relevant to their location, and should not be included. However, an image derived from a photograph taken from a vessel approaching the bridge may be considered relevant.
- Suitability for display in ECDIS: Graphics should be such that all the information in the graphic is legible in the ECDIS display. For example, text included in diagrams or tables must be large

enough so as to be legible when the file is opened in the ECDIS display. Images included in a graphical file should also be appropriately scaled such that they comfortably fit in the picture display window on the ECDIS (i.e. do not only take up a very small area of the window; or are so large that the image needs to be panned to see the entire image). Consideration must also be given to variation in ships' bridge lighting conditions. It is recommended that, where possible, associated files are tested by opening the file in an ECDIS prior to publication of the ENC.

Remarks:

- Clause 5.4.1 of the ENC Product Specification (S-57 Appendix B.1) specifies the content of an ENC exchange set, including the option to include picture files. The clause mandates the use of TIF as the format to be used for these files, but states additionally that "Files in other formats (including application files that may be used to manipulate text or picture files) may be included in an exchange set by private agreement between the producer and the receiver". Additionally, clause 5.6.4 also mandates the use of TIF file formats for picture files, but states additionally "Files in other formats, provided through private agreements, should follow the same general naming convention and use the appropriate file extension to indicate their format".

Many Type Approved ECDIS's have been developed to accept only TIF files when generating the SENC as mandated in the ENC Product Specification. This has resulted in these ECDIS's failing to load picture files in formats other than TIF.

When creating ENC exchange sets for general navigational distribution, picture files must be included **only in TIF (.TIF) format**.

#### 4.8.21 Signs and Notice boards

If it is required to encode a fixed or floating sign or notice board, it must be done using a **BCNSPP** object (see clause 12.3.1) or **BOYSPP** object (see clause 12.4.1), with attribute CATSPM = 18 (notice mark), or using the object class **DAYMAR** (see clause 12.3.3).

Remarks:

- If it is required to encode a sign or notice board that has more than one colour, the attributes COLOUR and COLPAT must be used, according to the rules laid out in clause 2.4.
- If it is required to encode any text shown on a notice board or sign, it must be done using the attribute INFORM.
- If it is required to encode the shape and colour of a notice board, it must be done by encoding the board as a **DAYMAR** object.

## 5 Depth

### 5.1 Sounding datum

See clause 2.1.3.

### 5.2 Depth contours (see S-4 – B-411)

Geo object: Depth contour (**DEPCNT**) (L)  
 Attributes: VALDCO - value of depth contour  
 (negative value for drying contours).  
~~VERDAT~~ INFORM NINFOM

The boundary of a drying rocky area (see INT1 - J20) or coral reef (see INT1 - J22) may be coincident with the zero metre contour (see (fg) in Figure 4). If it is required to encode this boundary, it must be done using the object class **DEPCNT** with the attribute VALDCO = 0.

On paper charts, the presentation of contours in areas of steep slope is sometimes generalised so that closely spaced contours are removed to leave a single contour (see (ab) in Figure 4). In such cases, this contour must be encoded using the shallowest depth of the slope.

Wherever possible, contours must be closed, or connected to the border of the cell, a coastline feature or another contour, in order to define closed areas.

Spatial objects associated with approximate contours should be encoded using the attribute QUAPOS = 4 (approximate).

Remarks:

- Producing Authorities should, as a minimum, use standardised depth contour intervals (refer S-4 – B-411). Additional depth contours may be added, where required.

### 5.3 Soundings (see S-4 – B-412 and B-413.1)

Geo object: Sounding (**SOUNDG**) (P)  
 Attributes: EXPSOU - indicates objects with a “value of sounding” within or not within the range of depth of the surrounding area (but see **NOTE** below).  
NOBJNM OBJNAM  
QUASOU - see table 5.1 below.  
SOUACC - see use of the meta object **M\_QUAL** (clauses 2.2.3.1 and 2.2.3.4).  
STATUS - 18 - existence doubtful.  
TECSOU - only for lower reliability soundings.  
~~VERDAT~~ INFORM NINFOM  
SORDAT - see table 5.1 below.

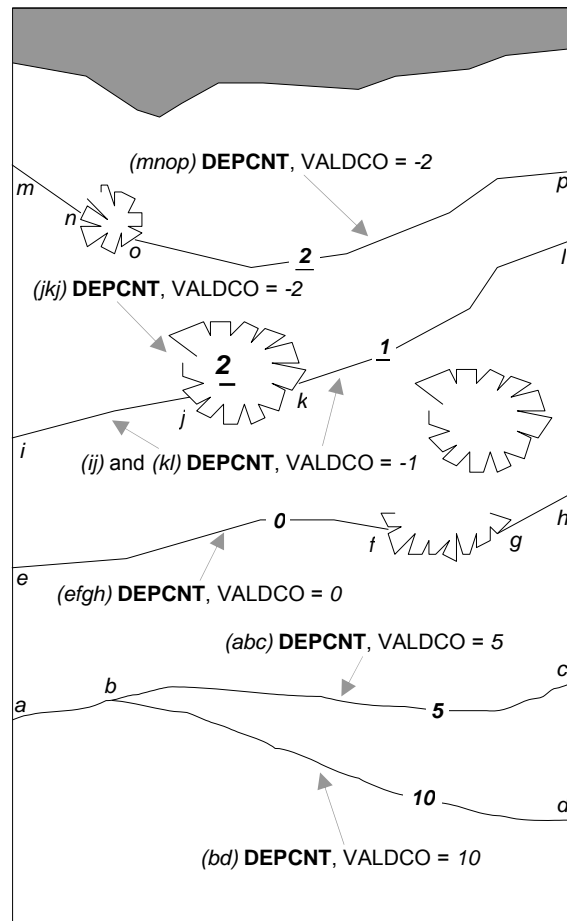

Figure 4 – Depth contours

Sounding	S-4	INT 1	QUAPOS	QUASOU	Remarks
In true position	B-412.1	I10		1	Should be encoded using QUAPOS = 10
Out of position on paper chart	B-412.2	I11 I12		1	Spatial object must be encoded at the true position. There is no "sounding, out of position" in an ENC.
No bottom found	B-412.3	I13		5	For "no bottom found" soundings, where the value of the sounding is less than the depth of the surrounding depth area, the value EXPSOU = 2 (shoaler than the depth of the surrounding depth area) should be populated (valid exception to <b>NOTE</b> below).
Lower reliability	B-412.4	I14	4	4	
Drying	B-413.2	I15		1	Negative value
Doubtful	B-424.4	I2		3	Existence doubtful should be encoded using STATUS = 18
Reported but not confirmed	B-424.5 C-404.3	I3 I4	8	9	If available, the year of report must be encoded using the attribute SORDAT

table 5.1

A sounding associated with a rock or coral pinnacle which is an obstruction to navigation must be encoded using the object class **UWTROC** (INT1 – K14) with attribute VALSOU populated with the value of the sounding.

The geometry of soundings is held in a 3 dimensional array (latitude, longitude, depth). In the interests of efficiency, multiple soundings should be encoded in one spatial object, provided that all the spatial and geo object attributes are common to the group.

As the sounding multiplication factor (SOMF) for ENC is always 10, soundings must only be encoded to one decimal place of a metre. Drying soundings must be indicated by a negative value.

For soundings surrounded by a danger line, see clause 6.3.

**NOTE:** Use of the attribute EXPSOU indicates whether the "value of sounding" is within or not within the range of depth of the surrounding depth/dredged area. This allows a **SOUNDG** object having a shoaler "value of sounding" than the depth/dredged area in which it lies, to be encoded on an ENC. The object class **SOUNDG** is not included in the list of SENC information to be displayed in either the Base Display or the Standard Display modes on the ECDIS unless requested by the operator through menu selection. Therefore soundings shoaler than a vessels safety depth, as set on the ECDIS, will not be displayed when using the Base Display or Standard Display settings. In addition, there is no guarantee that the ECDIS anti-grounding system will detect such soundings either in route planning or passage monitoring modes. This may result in a potential hazard to navigation being undetected by the mariner or the system in use.

It is therefore strongly advised not to use the attribute EXPSOU = 2 (shoaler than the range of depth of the surrounding depth area) for **SOUNDG** objects. Where a sounding is encountered that is shoaler than the range of depth of the surrounding depth/dredged area, encoders are strongly advised to conduct further investigation of source material in order to encode additional depth contour and depth area information more relevant to the sounding. Alternatively, encoders should consider using an alternate object class from **SOUNDG** (e.g. **OBSTRN** – see clause 6.2.2) to encode the depth. For additional guidance on encoding shoal depths in dredged areas, see clause 5.5.

## 5.4 Depth areas

### 5.4.1 Geo object depth areas

The sea area, the intertidal area and the navigable parts of rivers, lakes and canals must be divided into depth areas, each of them having a range of depth.

As many depth areas as possible must be created using encoded depth contours.

There is no longer a requirement to encode **DEPARE** of type line in ENC. **DEPARE** of type line in existing data sets will be treated as redundant data and must be removed at the next edition of the ENC.

**DEPARE** objects of type area are part of Group 1.

Geo object: Depth area (**DEPARE**) (A)  
 Attributes: DRVAL1 - (see clause 5.4.3).  
DRVAL2 - (see clause 5.4.3).  
 QUASOU SOUACC VERDAT INFORM NINFOM

### 5.4.2 Geometry of depth areas

Where areas are not closed on the source, it may be necessary to close these areas using edges without associated line objects. This is mandatory at the boundary of a cell (see Figure 5).

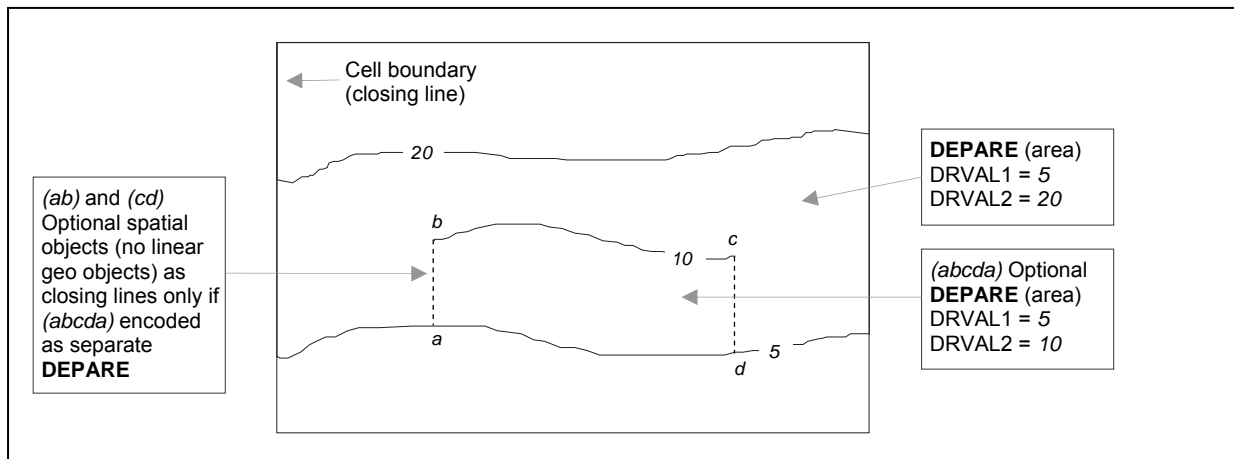

Figure 5 – Geometry of depth areas

Remarks:

- For short isolated sections of **DEPCNT** objects such as  $(bc)$ , it is up to the Producing Authority to determine whether to encode the small area  $(abcd)$  as a separate **DEPARE** object of type area, or to encode only the line  $(bc)$  as a “floating” **DEPCNT** object within a single **DEPARE** area having attributes  $DRVAL1 = 5$  and  $DRVAL2 = 20$ .

### 5.4.3 Use of attributes DRVAL1 and DRVAL2 for depth areas in general

For each depth area of type area, **DRVAL1** and **DRVAL2** should be encoded with the values corresponding to the shallowest and deepest depths in that area. These values, except for the shallowest and deepest areas, should be chosen from the values of the depth contours encoded in the data set.

A drying area, within which a drying height is indicated without a true position, should be encoded using a **DEPARE** object, with **DRVAL1** set to the value of the drying height and **DRVAL2** set to a data set contour value (usually zero). Alternatively, **DRVAL1** for the **DEPARE** may be set to  $-H$  (see NOTE (a) associated with Figure 6 below for definition of  $H$ ), with the drying height encoded using the attribute **INFORM** on the **DEPARE** object (e.g. *Dries 1.4*).

If a depth area is adjacent to a non-navigable waterway, a closing line (i.e. no linear geo object) should be encoded at the boundary between navigable and non-navigable waters. See clause 5.4.8.

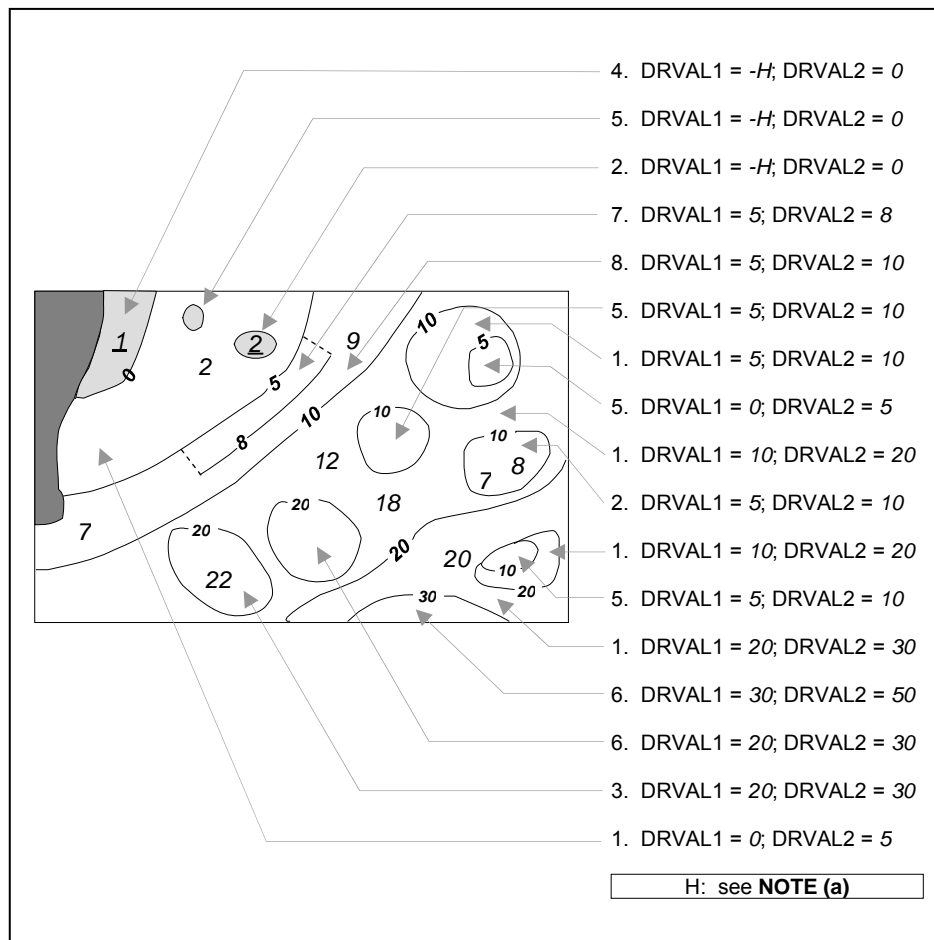

**Figure 6 – Depth areas**

**NOTE (a):** H = Height of the coastline datum above sounding datum, or a rounded value (e.g. (1) the value of the highest drying contour indicated on the source document; or (2) zero, if the coastline datum is the same as the sounding datum).

In the following clauses, the paragraph numbers refer to the item numbers in Figure 6. These clauses do not cover all encoding scenarios.

1. If the depth area is bounded by two or more depth contours:
  - DRVAL1 should take the value of the data set depth contour immediately shallower than the value of DRVAL2.
  - DRVAL2 should take the value of the deepest depth contour bounding the area.
2. If the deepest depth is shown by a depth contour, and the shallowest depth is shown by a sounding (a shoal):
  - DRVAL1 should take the value of the data set depth contour immediately shallower than the value of the sounding or -H.
  - DRVAL2 should take the value of the depth contour.
3. If the deepest depth is shown by a sounding and the shallowest depth is shown by a depth contour (a deep):
  - DRVAL1 should take the value of the depth contour.
  - DRVAL2 should take the value of the data set depth contour immediately deeper than or equal to the value of the sounding.

4. If the shallowest depth is defined by the coastline:
  - DRVAL1 should take the value of -H.
  - DRVAL2 should take the value of the shallowest data set depth contour bounding the area.
5. If the depth area is bounded by only one depth contour, contains no soundings, and is a shoal:
  - DRVAL1 should take the value of the data set depth contour immediately shallower than the value of the depth contour, or -H.
  - DRVAL2 should take the value of the depth contour.
6. If the depth area is bounded by only one depth contour, contains no soundings, and is a deep:
  - DRVAL1 should take the value of the depth contour.
  - DRVAL2 should take the value of the data set depth contour immediately deeper than the value of the depth contour.
7. If the depth area is bounded by an incomplete depth contour on one side (such as in incompletely surveyed area), and a complete depth contour on the other:
  - This area is optional. See clause 4.5.2 and Figure 5.
8. If the depth area is bounded by complete depth contours, but contains an incomplete (floating) depth contour:
  - DRVAL1 should take the value of the shallowest depth contour.
  - DRVAL2 should take the value of the deepest depth contour.

NOTE: This encoding is mandatory whether the optional depth area in paragraph 7 above is encoded or not.

#### 5.4.4 Not currently used

#### 5.4.5 Not currently used

#### 5.4.6 Not currently used

#### 5.4.7 Not currently used

#### 5.4.8 Rivers, canals, lakes, basins

Where these areas are navigable at compilation scale, they must be encoded using the Group 1 object classes **DEPARE**, **DRGARE** or **UNSARE**, and coastline-type object classes **COALNE** or **SLCONS**. If it is required to encode the nature and name of the area, it must be done using the object class **SEAARE**.

Where these areas are required and are not navigable at compilation scale, they must be encoded using the object classes **RIVERS**, **CANALS**, **LAKARE**, **DOCARE** or **LOKBSN**. These objects must be covered by **LNDARE** or **UNSARE** objects. Use of the object classes **CANBNK**, **LAKSHR** and **RIVBNK** is prohibited.

### 5.5 Dredged areas (see S-4 – B-414)

If it is required to encode dredged areas, this must be done using the object class **DRGARE**.

Geo object: Dredged area (**DRGARE**) (A)  
 Attributes: DRVAL1 - depth of dredging.  
               DRVAL2 - depth of dredging (if different to DRVAL1).  
               NOBJNM     OBJNAM  
               QUASOU - 10 - maintained depth.  
                           11 - not regularly maintained.  
                           If encoded, the value of QUASOU must be one of the above.  
               RESTRN  
               SOUACC - see use of **M\_QUAL** (clause 2.2.3.1).  
               TECSOU    ~~VERDAT~~    INFORM    NINFOM  
               SORDAT - date of dredging or last control survey.

## Remarks:

- **DRGARE** objects of type area are part of Group 1.
- The boundary of a dredged area should not have coincident linear geo objects encoded, unless part of the boundary corresponds to the shoreline (see clause 4.5).
- Dredged areas are often subject to siltation, resulting in shoaler depths being identified in the dredged area than the designed dredged depth. Where a **SOUNDG** object is encoded in a dredged area to indicate shoaler depths, the attribute value EXP SOU = 2 (shoaler than the depth of the surrounding depth area) should not be populated (see clause 5.3). Where required, the shoal depths should be encoded using **SOUNDG**, with the appropriate underlying depth information (**DEPARE** and, if required, **DEPCNT**) to support the depths. Alternatively, the attribute DRVAL2 for the **DRGARE** may be set to the designed dredged depth for the dredged area, and the attribute DRVAL1 set to the value of the shoalest depth, or a **CTNARE** object may be encoded covering the shoaler depth area with the depth information provided using the attribute INFORM. Where the shoal depths are close to the edge of the dredged area, the dredged area limit may be adjusted to exclude the shoal depths from the area. See also S-4 – B-414.5.
- The attribute SORDAT may be used to encode the year of the latest control survey for dredged areas where the dredged depth is not maintained. For dredged areas where the dredged depth is maintained, it is not required to indicate the year of dredging.

## 5.6 Swept areas (see S-4 – B-415)

If it is required to encode a swept area, it must be done using the object class **SWPARE**.

Geo object: Swept area (**SWPARE**) (A)  
 Attributes: DRVAL1 - swept depth.  
 QUASOU SOUACC  
 TECSOU - 6 - swept by wire-drag.  
 8 - swept by vertical acoustic system.  
 13 - swept by side scan sonar.  
 If encoded, the value of TECSOU must be one of the above.  
~~VERDAT~~ INFORM NINFOM  
 SORDAT - date of sweeping.

Spot soundings and depth contours shown in these areas must be encoded using **SOUNDG** and **DEPCNT** objects. Attributes QUASOU, SOUACC and TECSOU encoded on **SWPARE** apply to the swept area only. When it is required to encode the quality of spot soundings and depth contours, it must be done using the meta object **M\_QUAL** (see clause 2.2.3.1).

Even if the area contains no spot soundings or depth contours, a **SWPARE** object must overlap **DEPARE** or **DRGARE** objects. If there is insufficient depth information to allow the attributes DRVAL1 and DRVAL2 to be encoded on a **DEPARE** or **DRGARE** object, DRVAL1 should be set to the swept depth and DRVAL2 should be set to an empty (null) value.

## Remarks:

- When a swept area occupies an entire **M\_QUAL** area object and a **SWPARE** object is not defined separately, DRVAL1 for the **M\_QUAL** object must be used to encode the swept depth. The attribute SOUACC may be used on the **M\_QUAL** object to specify the accuracy of the swept depth defined by DRVAL1 - the attribute POSACC must not be used. There must be no depth or positional accuracy information provided for any underlying soundings within the swept area.
- When a swept area occupies an entire **M\_QUAL** area object and a **SWPARE** object is defined separately, the DRVAL1 value encoded on the **M\_QUAL** object must be the same as the DRVAL1 value encoded on the **SWPARE** object. SOUACC may be used on the **M\_QUAL** object to specify the accuracy of the swept depth - POSACC must not be used. There must be no depth or positional accuracy information provided for any underlying soundings within the swept area.
- When a **SWPARE** object exists within a **M\_QUAL** object, SOUACC must only be used on the **M\_QUAL** object if the same depth accuracy applies to the swept depth and to the soundings outside the swept area. POSACC must only be used to encode the accuracy of depths falling outside the boundaries of the swept area. There must be no depth or positional accuracy information provided for any underlying soundings within the swept area.



- **SWPARE** objects should not overlap.

## 5.7 Areas of continual change (see S-4 – B-416)

If it is required to encode an area of continually changing depth, it must be done using the object class **CTNARE** (see clause 6.6). Caution notes in such areas must be encoded using the attributes **INFORM** or **TXTDSC**.

Such areas must always overlap **DEPARE** objects.

An area on the source with the indication "Less water" should be encoded using this method.

If it is required to encode sandwaves, this must be done using the object class **SNDWAV** (see clause 7.2.1).

## 5.8 Areas with inadequate depth information (see S-4 – B-417 and B-418)

### 5.8.1 Unsurveyed areas

Areas with no bathymetric survey information, and falling within a meta object **M\_COVR** area with attribute **CATCOV = 1** (coverage available), must be encoded using the object class **UNSARE** (see clause 5.8.1.1 below for exception).

Geo object:    Unsurveyed area (**UNSARE**)        (A)  
Attributes:    **INFORM**    **NINFOM**

Remarks:

- **UNSARE** objects of type area are part of Group 1.

#### 5.8.1.1 Satellite imagery as source information (see S-4 – B424.7)

In some areas source information may be limited to shallow water depth information derived from satellite imagery. Where defined depths can be interpolated from satellite imagery (e.g. the drying line, 5 metre or 10 metre depth contours), and little or no reliable source survey information exists in the area, consideration should be given to showing this information in ENCs.

If it is required to encode shoal areas which have been derived from satellite imagery, **DEPARE** and **DEPCNT** objects of an appropriate depth range should be used. This should only be done in areas which have not been systematically surveyed. Areas of depth information derived from satellite imagery should be covered by **M\_QUAL** meta objects (see clause 2.2.3.1) having the appropriate value for the attribute **CATZOC** (i.e. 4 (zone of confidence C) or 5 (zone of confidence D)), and having attribute **TECSOU** populated as *11* (satellite imagery).

### 5.8.2 Incompletely surveyed areas

An incompletely surveyed area should be encoded using either an **UNSARE** object, within which soundings and contours may be encoded (but not depth areas), or using **DEPARE** objects. The attributes **DRVAL1** and **DRVAL2** for such depth areas should have explicit values.

The area must also be covered by **M\_QUAL** meta objects (see clause 2.2.3.1), with suitably defined attribute **CATZOC** values. Further information may be given using the meta object **M\_SREL** (see clause 2.2.3.2), where appropriate.

A cautionary note should also be encoded using a **CTNARE** object of type area (see clause 6.6).

### 5.8.3 Bathymetry in areas of minimal depiction of detail on paper charts

Where areas of little or no depth information exist within a specified ENC usage, they should be encoded using one of the following options:

### 5.8.3.1 Areas of omitted bathymetry

Encoders are advised that when encoding areas of bathymetry from paper charts containing minimal depth detail at scales that correspond to the ENC Navigation Purpose, to consult larger scale paper charts or ENC Navigation Purpose cells and generalise the bathymetry from this data. This is done to ensure that sufficient information is encoded so as not to conflict with larger scale coverage. The following is the recommended minimum encoding requirement in such cases:

Where larger compilation scale ENC coverage is available, the larger compilation scale cells should be examined to determine the shallowest **DEPARE** object, other than the intertidal area, within the whole of the area. Intertidal areas should then be generalised from the larger scale coverage, and one **DEPARE** object may then be created, with attributes DRVAL1 and DRVAL2 encoded from the values obtained from the larger scale, corresponding to the remaining area of bathymetry.

Where larger scale coverage does not exist, a single **DEPARE** object may be created to cover the area of omitted bathymetry. The DRVAL1 value of the **DEPARE** object should be set to the shallowest value appropriate to the colour tint that is applied to it (e.g. if blue tint is used for 5-20m areas, the DRVAL1 value for the area of omitted bathymetry should be set to 5). The DRVAL2 value should be set to the shallowest value of the surrounding Group 1 polygons.

In either case, the areas should be covered by a **CTNARE** object, the boundary of which follows exactly the surrounding Group 1 objects (see clause 2.8.2).

Encoders should consider the effect of over-generalising areas of omitted bathymetry on the ECDIS display as the mariner “zooms out” through the ENC Navigational Purposes.

### 5.8.3.2 Areas of very simplified bathymetry

In these areas, information relating to bathymetry (e.g. depth contours, dangers, rocky areas, isolated rocks, nature of the seabed, dredged areas, unsurveyed areas) should be individually encoded as normal.

A **CTNARE** object should be created covering the **DEPARE** objects of type area, within the area of simplified bathymetry, in order to encode a cautionary note (see clause 2.8.2).

### 5.8.4 Depth discontinuities between surveys (see S-4 – B-416.1)

Depth discontinuities between adjoining or overlapping source bathymetric surveys may be caused by:

- Surveys in areas of continually changing depth (see clause 5.7) conducted with a significant time gap between the surveys; or
- Adjoining areas having significant differences in the quality of bathymetric data (see clause 2.2.3.1).

It may not be possible to safely resolve significant depth discontinuity by interpolating approximate depth contours, which may compromise the ability for the compiler to adequately encode complete, non-overlapping Group 1 coverage of the area of the ENC cell covered by data. Where it is required to indicate these significant depth discontinuities, it should be done by encoding a “very narrow” **UNSARE** object (see clause 5.8.1).

The “very narrow area” should be about 0.2mm in width at ENC compilation scale (see clause 2.2.6).

Remarks:

- An indication of the purpose of the **UNSARE** may be done by population of the attribute INFORM, e.g. *Discontinuity between surveys*.
- In order to provide an indication to the mariner of the more reliable encoded bathymetry in an area of continually changing depth, the attribute CATZOC should be downgraded for the **M\_QUAL** object (see clause 2.2.3.1) corresponding to the less reliable (or older) data.

## 6 Dangers

### 6.1 Rocks and coral reefs (see S-4 – B-421)

Due to possible ECDIS display issues isolated dangers of type point (object classes **UWTROC**, **WRECKS** and **OBSTRN**) should be encoded as isolated nodes, i.e. they should not be encoded on connected nodes.

#### 6.1.1 Rocks which do not cover (islets)

An area feature must be encoded using:

- A **LNDARE** object of type area (mandatory)
- **COALNE** or **SLCONS** objects of type line (mandatory)
- **LNDELV** objects of type line and/or point (optional)

A line feature must be encoded using:

- A **LNDARE** object of type line (mandatory)
- **LNDELV** objects of type point (optional)

A point feature must be encoded using:

- A **LNDARE** object of type point (mandatory)
- A **LNDELV** object of type point (optional)

#### 6.1.2 Rocks which may cover

These rocks may cover and uncover, may be awash, or may be always underwater.

Geo object: Underwater / awash rock (**UWTROC**) (P)  
 Attributes: EXPSOU - indicates objects with a “value of sounding” within or not within the range of depth of the surrounding area.  
 NATQUA  
 NATSUR - 9 - rock.  
           14 - coral.  
           18 - boulder.  
 NOBJNM OBJNAM  
 QUASOU - see table 6.1 below.  
 SOUACC - see use of the meta object **M\_QUAL** (clause 2.2.3.1).  
 STATUS - 18 - existence doubtful.  
 TECSOU  
 VALSOU - see table 6.1 below.  
~~VERDAT~~  
 WATLEV - see table 6.1 below.  
 INFORM NINFOM  
 SORDAT - year of report, for reported but not confirmed danger.

Rock or coral reef	INT 1	WATLEV	QUASOU	Comment
Covers and uncovers, depth unknown	K11	4	2	See Remarks below for population of the attribute EXPSOU
Covers and uncovers, depth known	K11	4	any value except 2	Negative value for VALSOU
Awash	K12	5		
Underwater rock, depth unknown	K13	3	2	See Remarks below for population of the attribute EXPSOU
Underwater rock, depth known	K14	3	any value except 2	

Rock or coral reef	INT 1	WATLEV	QUASOU	Comment
Reported, not confirmed	I3.1,3.2	3,4 or 5	9	If available, the year reported should be encoded in SORDAT. The attribute QUAPOS should be set to 8 (reported, not confirmed).

table 6.1

## Remarks:

- All **UWTROC** objects should be encoded using one of the above combinations of attributes.
- A rock represented by a spot sounding and an associated nature of seabed (underwater rock not dangerous to surface navigation) may be encoded using a single **UWTROC** object.
- For area rock and coral reef features, see clause 7.1.
- When a group of rocks is surrounded by a danger line, each rock should be encoded as a separate **UWTROC** object covered by an obstruction area object (**OBSTRN** – see clause 6.2.2).
- If it is required to encode an **UWTROC** object where the attribute VALSOU is populated with an empty (null) value, but the source information indicates the depth of the object is within the range of the surrounding depth area, the value EXPSON = 1 (within the range of the surrounding depth area) should be populated in order to avoid the unnecessary display of isolated danger symbols in ECDIS.

## 6.2 Wrecks, foul ground and obstructions (see S-4 – B-422)

### 6.2.1 Wrecks

If it is required to encode a wreck, it must be done using the object class **WRECKS**.

Geo object: Wreck (**WRECKS**) (P,A)

Attributes: CATWRK - see table 6.2 and Remarks 2<sup>nd</sup> bullet point below.

CONRAD CONVIS

EXPSON - indicates objects with a “value of sounding” within or not within the range of depth of the surrounding area.

HEIGHT - only if WATLEV = 1 or 2.

NOBJNM OBJNAM

QUASOU - see table 6.2 below.

SOUACC - see use of the meta object **M\_QUAL** (clause 2.2.3.1).

STATUS - 13 - for historic wrecks.

18 - for existence doubtful.

If encoded the value of STATUS must be one of the above.

TECSOU - see table 6.2 below.

VALSOU ~~VERACC~~ ~~VERDAT~~ ~~VERLEN~~

WATLEV - see table 6.2 below.

INFORM NINFOM

In the following table, the symbol ‘/’ indicates that this attribute must not be encoded. A blank indicates that the encoder may choose a relevant value for the attribute.

Wrecks...	S-4	INT 1	CATWRK	WATLEV	QUASOU	TECSOU
Showing any part of hull or superstructure	B-422.2	K24 K20	5	1,2 or 4	/	/
Covers and uncovers	B-422.2	K24 K21	4 or 5	4		
Awash				5		
The mast only is visible at high water	B-422.2	K25	4 or 5	2	/	/
The mast only is visible at low water	B-422.2	K25	4	4		

Wrecks...	S-4	INT 1	CATWRK	WATLEV	QUASOU	TECSOU
Measured depth	B-422.4	K26		3	1 or 6	
Depth measured and swept by wire drag	B-422.3	K27		3	6	6
Depth measured by diver	B-422.3	K27		3	1 or 6	4
Depth unknown, considered dangerous by the responsible Producing Authority	B-422.6	K28	2	3	2*	/
Depth unknown, not considered dangerous by the responsible Producing Authority	B-422.6	K29	1	3	2*	/
Depth unknown, with a safe clearance	B-422.5	K30		3	7	/
Distributed remains of wreck	B-422.8	K31	3			
Reported, not confirmed	B-424.5	I3.1,3.2			9	

table 6.2

All wrecks should be encoded using one of the above combinations of attributes.

\* For a wreck where the least depth is unknown, the attribute value 2 (depth or least depth unknown) for QUASOU does not apply to the depth of the sea bottom near the wreck.

The provision of more quantitative information for wrecks where possible is particularly important in terms of the portrayal of wrecks in ECDIS. Conditional Symbology Procedures in the IHO Specifications for Chart Content and Display Aspects of ECDIS (S-52) Annex A – ECDIS Presentation Library, do not take into account the classification of wrecks as “dangerous” or “non-dangerous” when symbolising. This often results in wrecks being symbolised as an obstruction to navigation where they are actually non-dangerous. Where the depth of the wreck is unknown, compilers should consider determining an estimated safe clearance value (see S-4 – B-422.5) and populating QUASOU = 7 (least depth unknown, safe clearance at value shown).

Where a wreck is shown with its true shape (large scale chart), soundings and heights are often given inside a wreck to show the highest points of the hull or superstructure (e.g. mast, funnel). If it is required to encode such features, they must be done using:

- A **WRECKS** object of type area with all populated attributes applying to the highest point of the wreck.
- **LNDELV** objects of type point to encode the features of the wreck that are always dry; the type of each feature (e.g. mast, funnel) may be encoded using the attributes INFORM and NINFOM.
- **SOUNDG** objects to encode the features of wrecks which are always submerged, or cover and uncover; the type of each feature (e.g. mast, funnel) may be encoded using INFORM and NINFOM, which means that these soundings must be encoded individually.

Remarks:

- A **WRECKS** object of type area must be covered by an area object from Group 1 as appropriate.
- When encoding a **WRECKS** object, the attributes populated should adhere to the guidance in S-4 Clause B-422. Where possible, this includes the population of the attributes VALSOU and QUASOU where the depth of a wreck is known, or the depth is unknown but an estimated safe clearance can be determined. Where the depth is known, or the depth is unknown but an estimated safe clearance has been determined, it is not required to populate the attribute CATWRK = 1 (non-dangerous wreck) or 2 (dangerous wreck), as the mariner has the quantitative information in order to determine whether the wreck may be dangerous to their type of vessel.
- If it is required to encode a **WRECKS** object where the attribute VALSOU is not populated or is populated with an empty (null) value, but the source information indicates the depth of the object is within the range of the surrounding depth area, the value EXPSOU = 1 (within the range of the surrounding depth area) should be populated in order to avoid the unnecessary display of isolated danger symbols in ECDIS.

### 6.2.2 Obstructions, foul areas and foul ground

If it is required to encode snags, stumps, wellheads, diffusers, cribs, fish havens, foul areas, foul grounds, booms, ice booms, sites of cleared platforms or ground tackle, it must be done using the object class **OBSTRN**.

Geo object: Obstruction (**OBSTRN**) (P,L,A)  
 Attributes: CATOBS CONDTN  
 EXPSON - indicates objects with a “value of sounding” within or not within the range of depth of the surrounding area.  
 HEIGHT - only if WATLEV = 1 or 2.  
 NATCON NATQUA NATSUR NOBJNM OBJNAM  
 PRODCAT - only used for wellheads.  
 QUASOU - see table 6.3 below.  
 SOUACC - see use of the meta object **M\_QUAL** (clause 2.2.3.1).  
 STATUS - 18 - existence doubtful.  
 TECSOU - see table 6.3 below.  
 VALSOU VERACC VERDAT  
 VERLEN - distance above the seabed.  
 WATLEV - see table 6.3 below.  
 INFORM NINFOM

In the following table, the symbol ‘/’ indicates that this attribute must not be encoded. A blank indicates that the encoder may choose a relevant value for the attribute.

Obstruction...	INT 1	WATLEV	QUASOU	TECSOU
Depth unknown	K40	3 or 4	2*	/
Least depth known	K41	3 or 4	1 or 6	
Swept by wire to the depth shown	K42	3	6	6
Measured by diver	K42	3	1 or 6	4

table 6.3

All obstructions should be encoded using one of the above combinations of attributes.

\* For an obstruction where the least depth is unknown, the attribute value 2 (depth or least depth unknown) for QUASOU does not apply to the depth of the sea bottom near the obstruction.

It is important when encoding obstructions to be aware of the distinction between attribute values CATOBS = 6 (foul area) and CATOBS = 7 (foul ground):

Foul areas are defined as areas of numerous uncharted dangers to navigation, and on paper charts this is represented using a danger line (see clause 6.6.3 and INT1 – K1), normally supported by shallow water blue tint and little, if any, additional depth information covering the area. When encoded on ENC, **OBSTRN** objects of type area with attribute CATOBS = 6 (foul area) will display in the ECDIS “base display” as an obstruction to navigation, with all associated alarms to indicate that it is unsafe for vessels to enter or transit the area.

Foul ground is defined as an area over which it is safe to navigate but which should be avoided for anchoring, taking the ground or ground fishing. On paper charts, this is represented using the maritime limit in general dashed black line, interspersed with foul ground “hash” symbols, or with an accompanying legend “Foul” (see INT1 – K31). The area is also covered by appropriate full depth representation. In some cases, the legend shown on the paper chart is expanded to “Foul Ground” or “Foul Area”. When encoded on ENC, **OBSTRN** objects of type area with attribute CATOBS = 7 (foul ground) will display in the ECDIS “other” display as a “foul area of seabed safe for navigation but not for anchoring”, indicating to the mariner that it is safe to enter or transit the area but hazardous to take the ground or undertake other subsurface activities.

In some cases the use of the paper chart legend “Foul Area” to indicate an area of foul ground has resulted in encoding in ENC of **OBSTRN** with CATOBS = 6 (foul area). This encoding has resulted in

the incorrect indication in the ECDIS that the area is unsafe for navigation, which is potentially confusing to the mariner.

Foul ground, over which it is safe to navigate but which should be avoided for anchoring, taking the ground or ground fishing, should be encoded using an **OBSTRN** object of type area or point, with attribute CATOBS = 7 (foul ground). Although the paper chart may depict a “Foul Area”, it should be determined whether it is in fact “Foul Ground” before encoding a value for the attribute Category of Obstruction (CATOBS).

Remarks:

- If the nature of a dangerous underwater object, dangerous underwater area, or floating object is not explicitly known, it must be encoded using **OBSTRN**.
- An **OBSTRN** object of type area must be covered by an area object from Group 1 as appropriate.
- If it is required to encode an **OBSTRN** object where the attribute VALSOU is populated with an empty (null) value, but the source information indicates the depth of the object is within the range of the surrounding depth area, the value EXPSOU = 1 (within the range of the surrounding depth area) should be populated in order to avoid the unnecessary display of isolated danger symbols in ECDIS.
- In certain circumstances where an obstruction is always dry (e.g. cribs), it may be covered by a **LNDARE** object.

## 6.3 Danger lines

### 6.3.1 Danger line around a point danger or an isolated sounding

In general terms, a danger line that surrounds a single symbol or sounding (e.g. INT1 - K28, K30, K40b, K41, K42 or K43.1b) should not be encoded as a separate area. However, when the danger line indicates the true shape of the feature, it should be encoded using **WRECKS** or **OBSTRN** objects of type area. A single sounding enclosed by a danger line should be encoded using an **OBSTRN** object of type point. The sounding value, in this case, must be encoded using the attribute VALSOU.

### 6.3.2 Danger line limiting an area of wrecks or obstructions

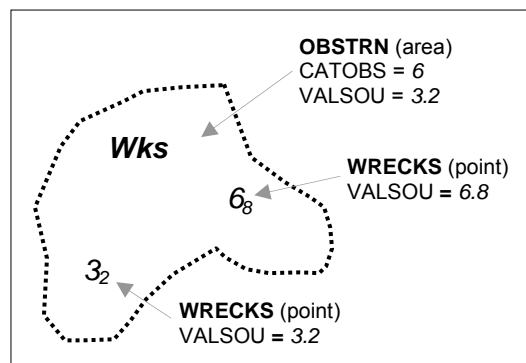

Figure 7 – Area of wrecks

The area enclosed by the danger line must be encoded using **WRECKS** or **OBSTRN** objects of type area, with the attribute values, when encoded, reflecting the characteristics of the shallowest point object encoded in the area. The area must also be covered by **DEPARE** or **UNSARE** objects as appropriate.

If it is required to encode one or more least depths in such an area, it must be done using a point object for each of the depths, in addition to the area object.

### 6.3.3 Danger line bordering an area through which navigation is not safe (see S-4 – B-420.1)

A danger line, bordering an area through which navigation is not safe, should be encoded using an **OBSTRN** object of type area, with attribute CATOBS = 6 (foul area).

## 6.4 Overfalls, races, breakers, eddies (see S-4 – B-423)

If it is required to encode a disturbance of water, it must be done using the object class **WATTUR**.

Geo object: Water turbulence (**WATTUR**) (P,L,A)  
 Attributes: CATWAT OBJNAM NOBJNM INFORM NINFOM

Remarks:

- If it is required to encode a breaker over an off-lying shoal, it must be done using a **WATTUR** object at the same position as the feature causing the breaker.
- A **WATTUR** object of type area must be covered by **DEPARE** or **UNSARE** objects as appropriate.

## 6.5 Doubtful dangers (see S-4 – B-424)

The fact that a danger is doubtful should be encoded using the feature attributes QUASOU and STATUS and the spatial attribute QUAPOS on the object:

	S-4	INT 1	QUAPOS	QUASOU	STATUS
Position approximate	B-424.1	B7	4		
Position doubtful	B-424.2	B8	5		
Existence doubtful	B-424.3	I1			18
Doubtful sounding	B-424.4	I2		3	
Reported danger	B-424.5	I3.1, 3.2	7 or 8	8 or 9	

table 6.4

Remarks:

- The same notions of approximate or doubtful positions and doubtful existence also apply to features other than dangers (e.g. landmarks, buoys).
- The text "Discoloured water" on the source indicates the probable existence of shallow water. This should be encoded using a **CTNARE** object with attribute INFORM or TXTDSC containing a cautionary note (see clause 6.6).

## 6.6 Caution areas

If it is required to identify an area in which the mariner must be aware of circumstances influencing the safety of navigation (e.g. an area of continually changing depths), and which cannot be encoded using existing feature objects, it must be done using the object class **CTNARE**. This object class may be required to identify a danger, a risk, a rule or advice that is not directly related to a particular object.

Geo Object: Caution area (**CTNARE**) (P,A)  
 Attributes: DATEND DATSTA PEREND PERSTA INFORM NINFOM TXTDSC  
 NTXTDS

Remarks:

- If the information applies to a specific area the **CTNARE** object should cover only that area.
- Information which may be of use to the mariner, but is not significant to safe navigation and cannot be encoded using existing feature objects, should be encoded using an **M\_NPUB** object (see clause 2.5), and using the attributes INFORM and/or TXTDSC (see clause 2.3). As **M\_NPUB** of type area do not display in ECDIS, such areas should be encoded to cover the entire area of data coverage for the cell. This encoding is intended to reduce the number of alarms or indications generated in the ECDIS due to the overuse of **CTNARE** objects.
- In order to ensure correct ECDIS display, **CTNARE** objects of type area should not share the geometry of objects such as **DEPCNT** and other objects with higher S-52 display priorities, as the **CTNARE** will appear to be "open ended", which may confuse the mariner. Where this occurs, the edge of the **CTNARE** should be extended outward to clear the "shared" edge, sufficient to avoid



“duplicate geometry” validation errors (i.e. about 0.2mm at the ENC compilation scale (see clause 2.2.6)).

## 7 Nature of the seabed

### 7.1 Description of the bottom (see S-4 – B-425 to B-427)

If it is required to encode an area of the sea where the nature of the bottom is homogeneous, it must be done using the object class **SBDARE**.

Geo object: Seabed area (**SBDARE**) (P,L,A)  
 Attributes: COLOUR NATQUA NATSUR  
 WATLEV NOBJNM OBJNAM  
 INFORM NINFOM

#### Remarks:

In the following clauses, the paragraph prefixes refer to the examples shown in Figure 8.

- (a) Mixed natures: The dominant nature of the seabed (NATSUR) should be given first. When there are qualifying terms (NATQUA) associated with the various natures of surface, the qualifying terms must be listed in the same order as the nature of surface list. Where a particular nature of surface has no qualifying term, the place in the list must be left empty and a delimiting comma must be encoded. For example, to encode a bottom quality such as "fine sand, mud and broken shells", the attributes NATSUR = 4,1,17 and NATQUA = 1,,4 must be encoded as shown. Where the last nature of surface in a list has no qualifying term, a trailing comma must be encoded. For example, "fine sand and mud" must be encoded with NATSUR = 4,1 and NATQUA = 1,.
- (b) Underlying material: Should be encoded in the same way as mixed natures, replacing the comma by a slash (/). The surface layer must be given first, followed by the underlying layers.
- (c) Coral reef, which is always covered, represented on paper charts as an area (INT1 - K16): An **OBSTRN** object of type area must be encoded with attributes CATOBS = 6 (foul area), NATSUR = 14 (coral) and WATLEV = 3 (always underwater/submerged). This object must be covered by a **DEPARE** or **UNSAARE** object as appropriate. In this area, some point dangers may be shown. An **UWTROC** object should be encoded for each individual point danger.
- (d) Hard bottom: The attribute NATQUA = 10 (hard) should be encoded, without being associated with NATSUR.
- (e) On the source, in the intertidal area or along the drying line, the nature of surface is sometimes shown by an open line rather than a closed area. In such cases, a **SBDARE** object of type line should be encoded, with attribute WATLEV = 4 (covers and uncovers).
- (f) If it is required to encode a rock pinnacle which is dangerous to navigation, it must be done using the object class **UWTROC**, while a rocky nature of seabed should be encoded using a **SBDARE** object of type point.
- (g) Where a **SBDARE** object of type area is located in an intertidal area, it should be encoded with WATLEV = 4 (covers and uncovers).

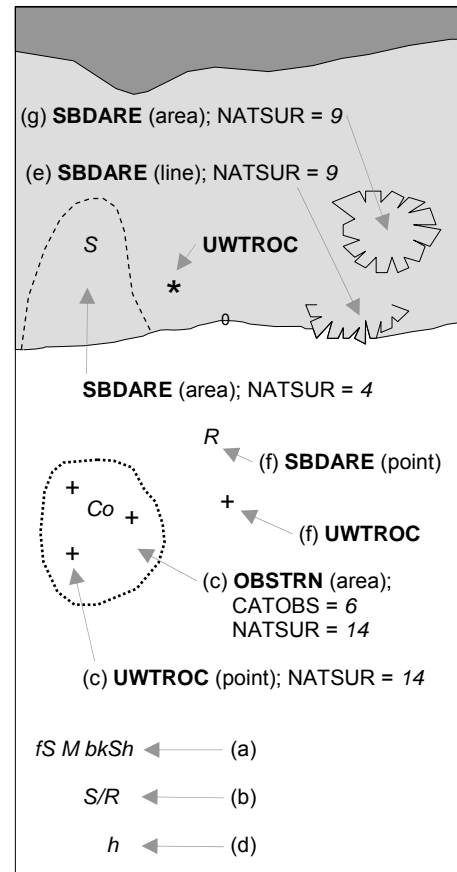

Figure 8 – Seabed areas

## 7.2 Special bottom types

### 7.2.1 Sandwaves (see S-4 – B-428.1)

If it is required to encode sandwaves, this must be done using the object class **SNDWAV**.

Geo object: Sandwaves (**SNDWAV**) (P,L,A)  
Attributes: ~~VERACC~~  
VERLEN - amplitude of the sandwave above the bottom.  
INFORM NINFOM

### 7.2.2 Weed - Kelp (see S-4 – B-428.2)

If it is required to encode marine weed or kelp, it must be done using the object class **WEDKLP**.

Geo object: Weed / kelp (**WEDKLP**) (P,A)  
Attributes: CATWED NOBJNM OBJNAM INFORM NINFOM

### 7.2.3 Springs in the seabed (see S-4 – B-428.3)

If it is required to encode a spring from the seabed, it must be done using the object class **SPRING**.

Geo object: Spring (**SPRING**) (P)  
Attributes: NOBJNM OBJNAM INFORM NINFOM

### 7.2.4 Tideways (see S-4 – B-413.3)

If it is required to encode a tideway, it must be done using the object class **TIDEWY**.

Geo object: Tideway (**TIDEWY**) (L,A)  
Attributes: NOBJNM OBJNAM INFORM NINFOM

Remarks:

- **TIDEWY** objects must be covered by **DEPARE**, **DRGARE** or **UNSARE** objects.

## 8 Sea areas (see S-4 – B-550)

Undersea features and sea areas in general, including intertidal areas, may be identified by their names and may be delimited by the spatial objects used by other geo objects (e.g. depth contours, coastlines). If it is required to encode these areas, this must be done using the object class **SEAARE**.

Geo object: Sea area (**SEAARE**) (P,A)  
Attributes: CATSEA NOBJNM OBJNAM INFORM NINFOM

### Remarks:

- This object class has a use similar to that of the object class **LNDRGN** (see clause 4.7.1), but for the sea.
- A **SEAARE** object of type area should be bounded, if possible, by existing lines used by other objects (e.g. **DEPCNT**, **COALNE**). If necessary, however, this area may be bounded by other lines created to close the area, or to describe a new area.
- For seas, oceans, gulfs and other types of sea area, where there is no specific value for the attribute **CATSEA**, the generic term 'Sea', 'Ocean', 'Gulf', etc may be included in the attributes **OBJNAM** and **NOBJNM**.
- **SEAARE** objects of type area may overlap.
- A **SEAARE** object of type area must be covered by objects from Group 1 (**DEPARE**, **DRGARE**, **UNSARE** etc).

## 9 Harbour regulations

### 9.1 Regulations within harbour limits

#### 9.1.1 Administrative harbour areas (see S-4 – B-430.1)

If it is required to encode an administrative harbour area, it must be done using the object class **HRBARE**.

Geo object: Harbour area (**HRBARE**) (A)  
 Attributes: NOBJNM OBJNAM STATUS INFORM NINFOM

Remarks:

- A masked line may be used to suppress the symbolisation of the boundary, where such symbolisation is considered inappropriate.

#### 9.1.2 Speed limits (see S-4 – B-430.2)

Speed is often limited inside harbours in order to prevent wakes. If it is required to encode this restriction, it must be done using a **RESARE** object (see clause 11.1) with the attribute CATREA = 24 (no wake area) or RESTRN = 13 (no wake). If it is required to encode cases where the speed limit is known, it must be done using RESTRN = 27 (speed restricted), with the speed limit and its unit of measurement encoded using the attribute INFORM (e.g. *Speed limit is 5 knots*).

If it is required to encode the buoys/beacons marking the **RESARE** object with speed limits, it must be done using **BCNSPP** or **BOYSPP** objects (see clauses 12.3.1, 12.4.1), with the attribute CATSPM = 24 (“reduced wake” mark) or 25 (speed limit mark). The speed limit and its unit of measurement should be encoded using the attribute INFORM (e.g. *Speed limit is 6 knots*).

## 9.2 Anchorages and prohibited/restricted anchorages; moorings

### 9.2.1 Anchorages (see S-4 – B-431.1; B-431.3 and B-431.7)

If it is required to encode an anchorage area, including anchorages for seaplanes, it must be done using the object class **ACHARE**.

Geo object: Anchorage area (**ACHARE**) (P,A)  
 Attributes: CATCH DATEND DATSTA NOBJNM  
 OBJNAM - name or number of the anchorage.  
 PEREND PERSTA RESTRN STATUS  
 INFORM - additional information about the category of anchorage.  
 NINFOM

Remarks:

- Individual reported anchorages without defined limits should be encoded as **ACHARE** objects of type point, with attributes CATCH = 1 (unrestricted anchorage), STATUS = 3 (recommended), and INFORM = *Reported anchorage*.
- For named **ACHARE** of type area, the name (when populated for the attribute OBJNAM) will not display in ECDIS. Where it is considered necessary to display the name of an anchorage area in ECDIS, a **SEAARE** object of type area should be encoded coincident with the **ACHARE** area. OBJNAM for the **SEAARE** should be populated with the name of the anchorage as has been populated for the **ACHARE**.
- Areas with numerous small craft moorings should be encoded as **ACHARE** objects of type area, with CATCH = 8 (small craft mooring area). For the encoding of mooring buoys, see clause 9.2.4.
- If it is required to encode an anchorage for seaplanes, it must be done using CATCH = 6 (seaplane anchorage).
- If it is required to encode an anchorage which may be used for a period of not more than 24 hours, it must be done using CATCH = 9 (anchorage for periods up to 24 hours).

- If it is required to encode an anchorage with a specific, limited time period, it must be done using **CATACH = 10** (anchorage for limited period of time). The specific limit of time should be encoded using the attribute **INFORM** (e.g. *Anchorage limited to 12 hours*).
- Areas where anchoring is prohibited must be encoded, where required, as **RESARE** (see clause 11.1) with attribute **RESTRN = 1** (anchoring prohibited).

### 9.2.2 Anchor berths (see S-4 – B-431.2)

If it is required to encode an anchor berth, it must be done using the object class **ACHBRT**.

Geo object: Anchor berth (**ACHBRT**) (P,A)  
 Attributes: **CATACH** **DATEND** **DATSTA** **NOBJNM**  
**OBJNAM** - name or number of the berth.  
**PEREND** **PERSTA**  
**RADIUS** - radius of the swinging circle in metres.  
**STATUS**  
**INFORM** - additional information about the category of anchorage.  
**NINFOM**

Remarks:

- If an anchor berth is defined by a centre point and a swinging circle, it should be of type point, with the radius of the swinging circle encoded using the attribute **RADIUS**.

### 9.2.3 Anchoring restricted (see S-4 – B-431.4)

If it is required to encode a restricted anchoring area, it must be done using a **RESARE** object, or using other objects with the attribute **RESTRN** (see clause 11.1), where **RESTRN = 1** (anchoring prohibited), **2** (anchoring restricted) or **7** (entry prohibited). Additional information about the restriction should be encoded using the attribute **INFORM** or **TXTDSC**.

### 9.2.4 Mooring buoys (see S-4 – B-431.5)

If it is required to encode a mooring buoy, it must be done using a **MORFAC** object (see clause 4.6.7.1), with attribute **CATMOR = 7** (mooring buoy).

### 9.2.5 Mooring trots (see S-4 – B-431.6)

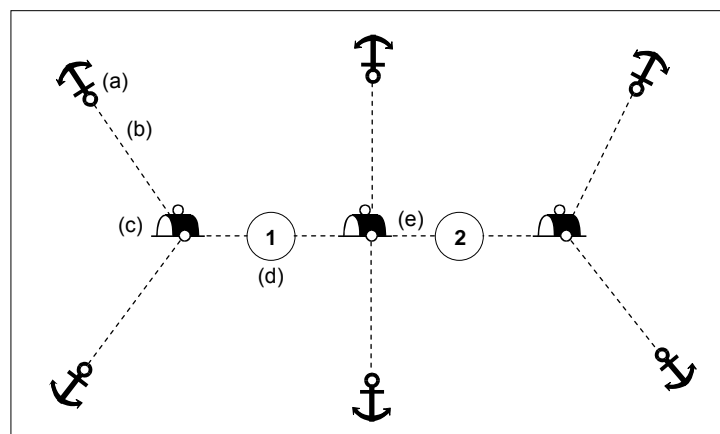

Figure 9 – Mooring trot

A complete mooring trot is composed of ground tackle, mooring cables, buoys and mooring berths on junction cables. The following remarks refer to the annotations in Figure 9 above:

- (a) Ground tackle should be encoded using **OBSTRN** objects (see clause 6.2.2), with attribute **CATOBS = 9** (ground tackle).
- (b) Mooring cables should be encoded using **CBLSUB** objects (see clause 11.5.1), with attribute **CATCBL = 6** (mooring cable/chain).

- (c) Buoys should be encoded using **MORFAC** objects (see clause 4.6.7.1), with attribute CATMOR = 7 (mooring buoy).
- (d) Mooring berths should be encoded using **BERTHS** objects (see clause 4.6.2).
- (e) Junction cables should be encoded using **MORFAC** objects (see clause 4.6.7.1), with attribute CATMOR = 6 (chain/wire/cable).

All these objects should be aggregated using the collection object **C\_AGGR** (see clause 15).

#### **9.2.6 Anchorage - relationships**

To encode an anchorage, objects such as **ACHARE**, **ACHBRT**, **MORFAC**, **RESARE**, **C\_AGGR** (mooring trots) and the anchorage's navigational aids objects may be associated using a collection object **C\_ASSO** (see clause 15).

## 10 Recommended tracks and routes

### 10.1 Leading, clearing and transit lines and recommended tracks (see S-4 – B-433 and B-434)

If it is required to encode leading, clearing and transit lines and recommended tracks, it must be done using the object classes **NAVLNE** and **RECTRC**, and related point navigational aids object classes. This applies for visual and radio navigational aids.

Relationships should be defined between these objects (see clauses 10.1.2 and 15)

NB. In North America the word “range” is used instead of “transit” and “leading line”.

#### 10.1.1 Navigation lines and recommended tracks

If it is required to encode a navigation line, it must be done using the object class **NAVLNE**.

Geo object: Navigation line (**NAVLNE**) (L)  
 Attributes: CATNAV DATEND DATSTA  
ORIENT - value of the bearing from seaward.  
 PEREND PERSTA STATUS  
 INFORM - legend as shown on the source.  
 NINFOM

If it is required to encode a recommended track, it must be done using the object class **RECTRC**.

Geo object: Recommended track (**RECTRC**) (L,A)  
 Attributes: CATTRK DATEND DATSTA  
DRVAL1 - minimum depth along the track.  
DRVAL2 NOBJNM OBJNAM ORIENT PEREND PERSTA QUASOU  
 SOUACC STATUS TECSOU TRAFIC VERDAT  
 INFORM - maximum authorised draft (e.g. *Maximum authorised draft = 14 metres*).  
 NINFOM

Remarks:

- The value 3 (recommended) should not be used on the attribute STATUS in this case because, by definition, **RECTRC** is recommended.
- The S-57 definition for attribute value CATTRK = 1 (based on a system of fixed marks) overlooks the possibility of a route being based on a single structure and a bearing, which is frequently the case. Therefore, **RECTRC** should also be used to encode a straight route which comprises a single structure or natural feature which may carry lights and/or top marks and a specified bearing which vessels can follow with safety.
- In the case of a two-way recommended track, only one value of orientation is encoded (in the attribute ORIENT); the other value can be deduced (i.e. the value in ORIENT +/- 180). The value of orientation encoded on the attribute ORIENT should be the value of the bearing from seaward. If it is not possible to define a seaward direction, the value that is less than 180° should be used.
- When the traffic flow along a recommended track of type line is one way (attribute TRAFIC = 1, 2 or 3), the resultant direction of the line (accounting for the direction of digitising and any subsequent reversal of the line) associated with the **RECTRC** must be the same as the direction of the traffic flow, in order to ensure the correct representation in the ECDIS of the direction to be followed.

The use of **NAVLNE** and **RECTRC** is defined in more detail in the following table, and in Figure 10 below:

Figure 10		NAVLNE	RECTRC	Navigational aids
1	Recommended track on a leading line	CATNAV = 3	CATTRK = 1	at least 2
2	Clearing line on marks in line	CATNAV = 1	none	at least 2



Figure 10		NAVLNE	RECTRC	Navigational aids
3	Transit line on marks in line	CATNAV = 2	none	at least 2
4	Recommended track on a bearing	CATNAV = 3	CATTRK = 1	1
5	Clearing line on a bearing	CATNAV = 1	none	1
6	Transit line on a bearing	CATNAV = 2	none	1
7	Recommended track not based on fixed marks	none	CATTRK = 2	none

table 10.1

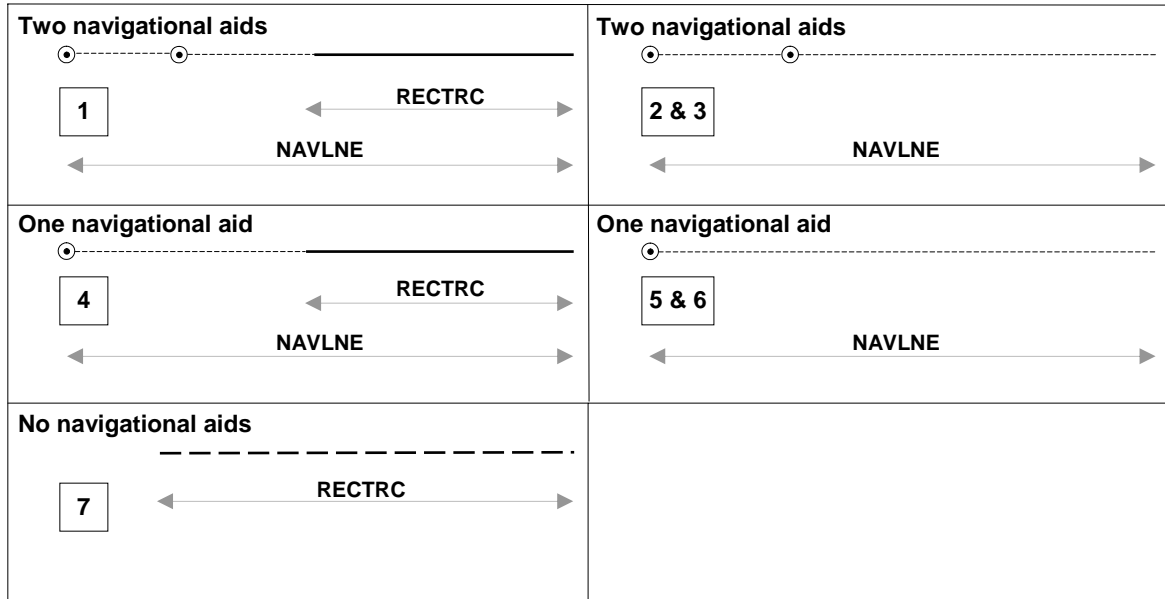

Figure 10 – Navigation lines and recommended tracks

Remarks:

- Even if, on the source, navigational aids are merged into only one symbol, one geo object must be created for each navigational aid.

### 10.1.2 Range systems - relationship

To encode a range system, the objects **NAVLNE**, **RECTRC** and the navigational aids objects should be aggregated using a collection object **C\_AGGR** (see clause 15).

This aggregation object may also be associated, using a collection object **C\_ASSO** (see clause 15), with the dangers (e.g. **OBSTRN**, **WRECKS**, **UWTROC** objects) marked by the clearing or transit line.

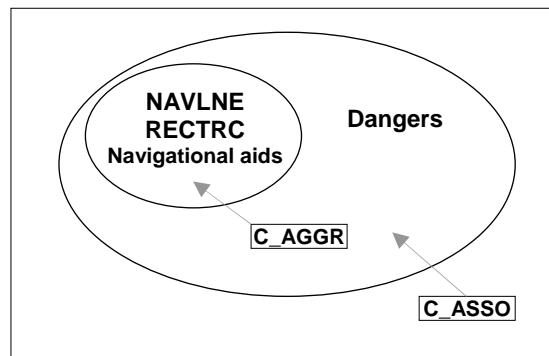

Figure 11 – Range systems

### 10.1.3 Measured distances (see S-4 – B-458)

If the track to be followed is on a leading line or a bearing, it must be encoded in the way described in table 10.1 and Figure 10 above (cases 1 or 4). If the track is not on a leading line or bearing, it must be encoded only as a **NAVLNE** object with the attribute CATNAV being set to an empty (null) value. In either case, if it is required to encode the measured distance, it must be done using the attribute INFORM (e.g. *Measured distance = 1450 metres*).

If it is required to encode the transit lines, they must be done using **NAVLNE** objects, with CATNAV = 2 (transit line).

If it is required to encode the beacons, they must be done using **BCNSPP** objects, with attribute CATSPM = 17 (measured distance mark).

Where the entire measured distance system exists within a single cell, each transit line with its beacons must be aggregated into a collection object **C\_AGGR** (see clause 15). These two aggregation objects and the track to be followed must be aggregated into another **C\_AGGR** object.

## 10.2 Routeing measures

### 10.2.1 Traffic separation schemes

If it is required to encode a traffic separation scheme, it must be done using **DWRTCL**, **DWRTPT**, **ISTZNE**, **PRCARE**, **TSELNE**, **TSEZNE**, **TSSBND**, **TSSCRS**, **TSSLPT**, **TSSRON** objects, and navigational aids objects.

The encoding of relationships between these objects is defined in clause 10.2.3.

For guidance on provision of advance notification of changes to traffic separation schemes, see clause 2.6.1.1.

#### 10.2.1.1 Traffic separation scheme lanes (see S-4 – B-435.1)

A complete traffic separation scheme lane consists of one or more areas within which the flow of traffic follows one defined direction. If it is required to encode these areas, this must be done using the object class **TSSLPT**.

Geo object: Traffic separation scheme lane part (**TSSLPT**) (A)  
 Attributes: CATTSS DATEND DATSTA  
ORIENT - direction of the traffic flow.  
 RESTRN STATUS INFORM NINFOM

Remarks:

- At junctions, other than crossings and roundabouts, a separate **TSSLPT** object must be encoded. For this object, the attribute ORIENT must be omitted, in order to avoid implying that one lane has priority over another (see INT1 – M22). Warning text may be encoded using the attribute INFORM or TXTDSC. In some cases, a precautionary area is established where routes meet or cross (see clause 10.2.1.8).

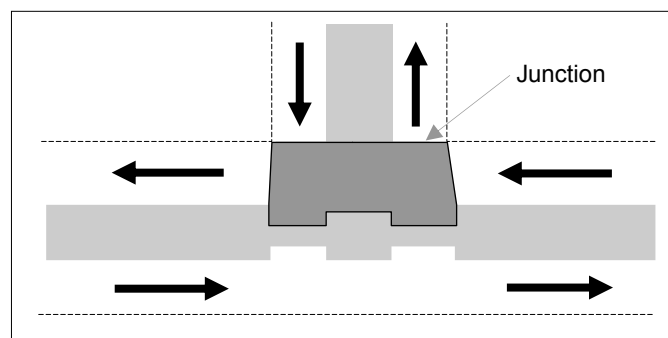

Figure 12 – Junction

- The orientation of the traffic separation scheme lane part is defined by the centreline of the part and is related to the general direction of traffic flow in the traffic separation scheme lane.

#### 10.2.1.2 Traffic separation scheme boundaries (see S-4 – B-435.1)

The object class **TSSBND** must only be used to encode the outer limits of traffic lanes or traffic separation scheme roundabouts.

Geo object: Traffic separation scheme boundary (**TSSBND**) (L)  
 Attributes: CATTSS DATEND DATSTA STATUS INFORM NINFOM

Remarks:

- **TSSBND** must not be used to encode the boundary between a traffic separation scheme lane or roundabout and a traffic separation zone; or a traffic separation zone and an inshore traffic zone.

#### 10.2.1.3 Traffic separation lines (see S-4 – B-435.1)

The object class **TSELNE** must only be used to encode the common boundary of two traffic lanes, or of one traffic lane and one inshore traffic zone.

Geo object: Traffic separation line (**TSELNE**) (L)  
 Attributes: CATTSS DATEND DATSTA STATUS INFORM NINFOM

#### 10.2.1.4 Traffic separation zones (see S-4 – B-435.1)

The object class **TSEZNE** must only be used to encode the separation areas between two traffic lanes, or of one traffic lane and one inshore traffic zone, or to encode the centre part of a roundabout.

Geo object: Traffic separation zone (**TSEZNE**) (A)  
 Attributes: CATTSS DATEND DATSTA STATUS INFORM NINFOM

#### 10.2.1.5 Traffic separation scheme crossings (see S-4 – B-435.1)

The object class **TSSCRS** must only be used to encode the area where at least four traffic lanes cross.

Geo object: Traffic separation scheme crossing (**TSSCRS**) (A)  
 Attributes: CATTSS DATEND DATSTA RESTRN STATUS INFORM NINFOM

Remarks:

- Junctions other than crossings and roundabouts should be encoded using the object class **TSSLPT** (see clause 10.2.1.1).
- A **TSSCRS** object must not overlap a **TSEZNE** object at its centre.
- In some cases, a precautionary area is established where routes meet or cross (see clause 10.2.1.8).

#### 10.2.1.6 Traffic separation scheme roundabouts (see S-4 – B-435.1)

The object class **TSSRON** must only be used to encode the area in which traffic moves in a counter-clockwise direction around a specified point or zone.

Geo object: Traffic separation scheme roundabout (**TSSRON**) (A)  
 Attributes: CATTSS DATEND DATSTA RESTRN STATUS INFORM NINFOM

Remarks:

- Junctions other than crossings and roundabouts should be encoded using the object class **TSSLPT** (see clause 10.2.1.1).
- A **TSSRON** object must not overlap a **TSEZNE** object at its centre.
- In some cases, a precautionary area is established where routes meet or cross (see clause 10.2.1.8).

### 10.2.1.7 Inshore traffic zones (see S-4 – B-435.1)

The object class **ISTZNE** must only be used to encode the designated area between the landward boundary of a traffic separation scheme and the adjacent coast.

Geo object: Inshore traffic zone (**ISTZNE**) (A)  
 Attributes: CATTSS DATEND DATSTA RESTRN STATUS INFORM NINFOM

### 10.2.1.8 Precautionary areas (see S-4 – B-435.2)

The object class **PRCARE** must only be used to encode an area, within defined limits, where ships must navigate with particular caution, and within which the direction of traffic flow may be recommended.

Geo object: Precautionary area (**PRCARE**) (P,A)  
 Attributes: DATEND DATSTA RESTRN STATUS INFORM NINFOM TXTDSC  
 NTXTDS

Remarks:

- A **PRCARE** object may overlap other objects encoded for the traffic separation scheme (e.g. **TSSRON**, **TSSLPT**, **TSSCRS**).

## 10.2.2 Deep water routes (see S-4 – B-435.3)

### 10.2.2.1 Deep water route parts

A complete deep water route (DW) consists of one or more areas within which the flow of traffic either follows one defined direction for one-way traffic, or follows one defined direction and its reciprocal for two-way traffic. If it is required to encode these areas, this must be done using the object class **DWRTPT**.

Geo object: Deep water route part (**DWRTPT**) (A)  
 Attributes: DATEND DATSTA  
DRVAL1 - minimum depth.  
DRVAL2 NOBJNM  
 OBJNAM - should only be used if the individual object is not aggregated in a collection object.  
ORIENT - direction of the traffic flow.  
QUASOU RESTRN SOUACC STATUS TECSOU TRAFIC VERDAT  
 INFORM NINFOM

Remarks:

- The route must be covered by **DEPARE** objects.
- A deep water route part may overlap a **TSSLPT** object.
- The orientation of the deep water route part is defined by the centreline of the part and is related to the general direction of traffic flow in the deep water route.
- To encode a complete deep water route, the **DWRTCL**, **DWRTPT** objects, and the navigational aids objects (if they are stated in the regulation defining the DW), may be aggregated using the collection object **C\_AGGR** (see clause 15). Where it is required to indicate the name of an aggregated DW, this should be done using a **SEAARE** object (see clause 8), or by populating OBJNAM for the most representative object in the DW. Where it is required to populate textual information for the DW, this should be done using a **M\_NPUB** object (see clauses 2.5), with attributes INFORM and/or TXTDSC (see clause 2.3), or if the information is considered essential for safe navigation, using a **CTNARE** object (see clause 6.6).
- Deep water routes may be included with other routing measures such as traffic separation schemes to comprise a complete traffic routing system. To encode the relationship between routing measures, the **C\_AGGR** defining each routing measure within the system (or the relevant object if the routing measure consists of a single object) may be aggregated using **C\_AGGR** to form a hierarchical relationship (see clause 15). The individual elements comprising different routing measures must not be aggregated into a single **C\_AGGR**.

### 10.2.2.2 Deep water route centrelines

If it is required to encode the centreline of a deep water route, the width of which is not explicitly defined, it must be done using the object class **DWRTCL**.

Geo object: Deep water route centreline (**DWRTCL**) (L)  
 Attributes: CATTRK DATEND DATSTA  
 DRVAL1 - minimum depth.  
 DRVAL2 NOBJNM  
 OBJNAM - should only be used if the individual object is not aggregated in a collection object or is the most representative object in a collection object (see clause 15).  
ORIENT QUASOU SOUACC STATUS TECSOU TRAFIC VERDAT  
 INFORM NINFOM

Remarks:

- In the case of a two-way deep water route centreline, only one value of orientation is encoded (in the attribute ORIENT); the other value can be deduced (i.e. the value in ORIENT +/- 180). The value of orientation encoded on the attribute ORIENT should be the value of the bearing from seaward. If it is not possible to define a seaward direction, the value that is less than 180° should be used.
- When the traffic flow is one way (attribute TRAFIC = 1, 2 or 3), the resultant direction of the line (accounting for the direction of digitising and any subsequent reversal of the line) associated with the **DWRTCL** must be the same as the direction of traffic flow, in order to ensure the correct representation in the ECDIS of the direction to be followed.

### 10.2.3 Traffic separation scheme systems

To encode a traffic separation scheme (TSS) system, the **DWRTCL**, **DWRTPT**, **ISTZNE**, **PRCARE**, **TSELNE**, **TSEZNE**, **TSSBND**, **TSSCRS**, **TSSLPT**, **TSSRON** objects, and the navigational aids objects (if they are stated in the regulation defining the TSS or DW), must be aggregated using the collection object **C\_AGGR** (see clause 15). Where it is required to indicate the name of the complete aggregated TSS, this should be done using a **SEAARE** object (see clause 8), or by populating OBJNAM for the most representative object in the TSS. Where it is required to populate textual information for the TSS, this should be done using a **M\_NPUB** object (see clauses 2.5), with attributes INFORM and/or TXTDSC (see clause 2.3), or if the information is considered essential for safe navigation, using a **CTNARE** object (see clause 6.6).

Remarks:

- Traffic separation scheme systems may be included with other routing measures such as deep water or two-way routes, or another traffic separation scheme system, to comprise a complete traffic routing system. To encode the relationship between routing measures, the **C\_AGGR** defining each routing measure within the system (or the relevant object if the routing measure consists of a single object) may be aggregated using **C\_AGGR** to form a hierarchical relationship (see clause 15). The individual elements comprising different routing measures must not be aggregated into a single **C\_AGGR**.

### 10.2.4 Recommended routes (see S-4 – B-435.4)

If it is required to encode the centreline of a recommended route, it must be done using the object class **RCRTCL**.

Geo object: Recommended route centreline (**RCRTCL**) (L)  
 Attributes: CATTRK DATEND DATSTA  
 DRVAL1 - minimum depth.  
 DRVAL2 NOBJNM OBJNAM ORIENT PEREND PERSTA QUASOU  
 SOUACC STATUS TECSOU TRAFIC VERDAT INFORM NINFOM

Remarks:

- In the case of a recommended route centreline, only one value of orientation is encoded (in the attribute ORIENT); the other value can be deduced (i.e. the value in ORIENT +/- 180). The value

of orientation encoded on the attribute ORIENT should be the value of the bearing from seaward. If it is not possible to define a seaward direction, the value that is less than 180° should be used.

- When the traffic flow is one way (attribute TRAFIC = 1, 2 or 3), the resultant direction of the line (accounting for the direction of digitising and any subsequent reversal of the line) associated with the **RCRTCL** must be the same as the direction of traffic flow, in order to ensure the correct representation in the ECDIS of the direction to be followed.

### 10.2.5 Recommended direction of traffic flow (see S-4 – B-435.5)

The object class **RCTLPT** should be used to encode areas with a recommended direction of traffic flow:

- between two TSS (INT1 - M26.1);
- in the entrance area of a TSS; or
- along the outside of a deep water route (INT1 - M26.2).

Geo object: Recommended traffic lane part (**RCTLPT**) (P,A)  
 Attributes: DATEND DATSTA ORIENT STATUS INFORM NINFOM

Remarks:

- When the area is not defined, a point object should be encoded.
- The orientation of the recommended traffic lane part is defined by the centreline of the part and is related to the general direction of traffic flow in the recommended traffic lane.

### 10.2.6 Two-way routes (see S-4 – B-435.6)

A two-way route consists of one or more areas within which traffic flows in two directions along one bearing and its reciprocal. If it is required to encode these areas, this must be done using the object class **TWRTPT**. These route parts will generally be two-way, but some may be restricted to one-way traffic flow (INT1 - M28.2).

Geo object: Two-way route part (**TWRTPT**) (A)  
 Attributes: CATTRK DATEND DATSTA  
 DRVAL1 - minimum depth.  
 DRVAL2 ORIENT QUASOU SOUACC STATUS TECSOU TRAFIC  
 VERDAT INFORM NINFOM

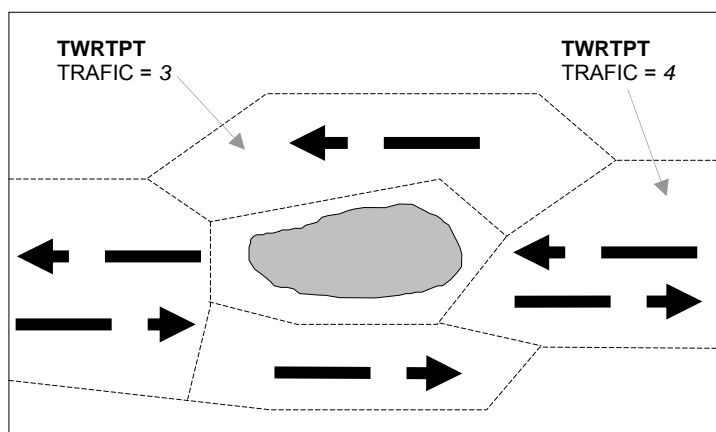

Figure 13 – One way traffic flow in two-way route

If it is required to encode a two-way route with one-way sections, separate **TWRTPT** objects must be encoded for the different parts, with attribute TRAFIC = 3 (one-way) or 4 (two-way). In one-way sections, the attribute ORIENT must indicate the true direction of traffic flow, not its reciprocal. In two-way sections, ORIENT may indicate either direction of traffic flow.

Remarks:

- The orientation of the two-way route part is defined by the centreline of the part and is related to the general direction of traffic flow in the two-way route.

- To encode a complete two-way route, the **TWRTPT** objects may be aggregated using the collection object **C\_AGGR** (see clause 15). Where it is required to indicate the name of an aggregated two-way route, this should be done using a **SEAARE** object (see clause 8), or by populating **OBJNAM** for the most representative object in the two-way route. Where it is required to populate textual information for the two-way route, this should be done using a **M\_NPUB** object (see clauses 2.5), with attributes **INFORM** and/or **TXTDSC** (see clause 2.3), or if the information is considered essential for safe navigation, using a **CTNARE** object (see clause 6.6).
- Two-way routes may be included with other routing measures such as traffic separation schemes to comprise a complete traffic routing system. To encode the relationship between routing measures, the **C\_AGGR** defining each routing measure within the system (or the relevant object if the routing measure consists of a single object) may be aggregated using **C\_AGGR** to form a hierarchical relationship (see clause 15). The individual elements comprising different routing measures must not be aggregated into a single **C\_AGGR**.

### 10.2.7 Areas to be avoided (see S-4 – B-435.7)

If it is required to encode an area to be avoided, it must be done using a **RESARE** object (see clause 11.1), with attribute **RESTRN = 14** (area to be avoided). An area to be avoided around a navigational aid must also be encoded with attribute **CATREA = 12** (navigational aid safety zone).

### 10.3 Ferries (see S-4 – B-438)

If it is required to encode a ferry route, it must be done using the object class **FERYRT**.

Geo object: Ferry route (**FERYRT**) (L,A)  
 Attributes: CATFRY DATEND DATSTA NOBJNM OBJNAM PEREND PERSTA  
 STATUS INFORM NINFOM

### 10.4 Fairways (see S-4 – B-432.1 and B-434.5)

If it is required to encode a fairway, it must be done using the object class **FAIRWY**.

Geo object: Fairway (**FAIRWY**) (A)  
 Attributes: DATEND DATSTA  
 DRVAL1 - minimum depth in the fairway.  
 NOBJNM OBJNAM ORIENT QUASOU RESTRN SOUACC STATUS  
 TRAFIC ~~VERDAT~~ INFORM NINFOM

Remarks:

- A collection object **C\_AGGR** or **C\_ASSO** (see clause 15) should be created to relate a fairway with associated navigational aids, recommended tracks, dredged areas, and other regulated areas.
- Where beacons or buoys marking a fairway are offset from the actual fairway limits, this should be indicated using the attribute **INFORM** on the **FAIRWY** object.

### 10.5 Archipelagic Sea Lane

If it is required to encode an Archipelagic Sea Lane, it must be done using **ARCSLN** and/or **ASLXIS** objects, and possibly navigational aids objects.

The unique character of Archipelagic Sea Lanes (ASLs) is specified by UNCLOS Article 53 and Part H, General Provision of IMO Ships Routing.

The encoding of relationships between these objects is defined in clause 10.5.3.

Remarks:

- In some cases only accurate information on the axes (**ASLXIS**) may be available and in such cases the extents of the ASL (**ARCSLN**) may not be able to be encoded.

#### 10.5.1 Archipelagic Sea Lanes (see S-4 – B-435.10)

The object class **ARCSLN** must only be used to encode the area of an Archipelagic Sea Lane.

Geo object: Archipelagic Sea Lane (**ARCSLN**) (A)  
 Attributes: DATEND DATSTA NATION NOBJNM OBJNAM

### 10.5.2 Archipelagic Sea Lane Axis (see S-4 – B-435.10)

The object class **ASLXIS** must only be used to encode the axes defining an Archipelagic Sea Lane.

Geo object: Archipelagic Sea Lane Axis (**ASLXIS**) (L)  
 Attributes: DATEND DATSTA NATION NOBJNM OBJNAM

### 10.5.3 Archipelagic Sea Lane systems

To encode an Archipelagic Sea Lane (ASL) system, the **ARCSLN**, **ASLXIS** objects, and any navigational aids objects (if they are stated in the regulation defining the ASL), should be aggregated using the collection object **C\_AGGR** (see clause 15). Where it is required to indicate the name of the ASL system, this should be done using a **SEAARE** object (see clause 8), or by populating OBJNAM for the most representative object in the ASL system. Where it is required to populate textual information for the ASL system, this should be done using a **M\_NPUB** object (see clauses 2.5), with attributes INFORM and/or TXTDSC (see clause 2.3), or if the information is considered essential for safe navigation, using a **CTNARE** object (see clause 6.6).



## 11 Regulated areas

### 11.1 Restricted areas in general (see S-4 – B-439.2 to B-439.4)

If it is required to encode a restricted area, it must be done using the object class **RESARE**, or using other object classes having the attribute **RESTRN** (**ACHARE**, **CBLARE**, **DMPGRD**, **DRGARE**, **DWRTPT**, **FAIRWY**, **ICNARE**, **ISTZNE**, **MARCUL**, **MIPARE**, **OSPARE**, **PIPARE**, **PRCARE**, **SPLARE**, **SUBTLN**, **TESARE**, **TSSCRS**, **TSSLPT**, **TSSRON**).

Geo object: Restricted area (**RESARE**) (A)  
 Attributes: CATREA - describes the reason for the regulation.  
 DATEND DATSTA NOBJNM OBJNAM PEREND PERSTA  
RESTRN - describes the restrictions.  
 STATUS  
 INFORM - a short explanation about the regulation (e.g. caution note from paper chart). The attribute **TXTDSC** may be used instead of **INFORM**, or for longer explanations or notes.  
 NINFOM

Remarks:

- The current S-57 definition for restricted area covers only those areas where navigation is restricted. Restricted areas should be interpreted as also covering areas of restricted access, including areas on land.
- The S-57 definition for attribute values **CATREA** = 4 (nature reserve) and **CATREA** = 23 (ecological reserve) should be interpreted as including water areas.
- If it is required to encode an area for which the mariner must be made aware of circumstances influencing the safety of navigation, it must be done using the object class **CTNARE** (see clause 6.6). This object class may be used to identify a danger, a risk, a rule or advice (e.g. an area of continually changing depths) which is not directly related to a particular object.

### 11.2 Maritime jurisdiction areas (see S-4 – B-440)

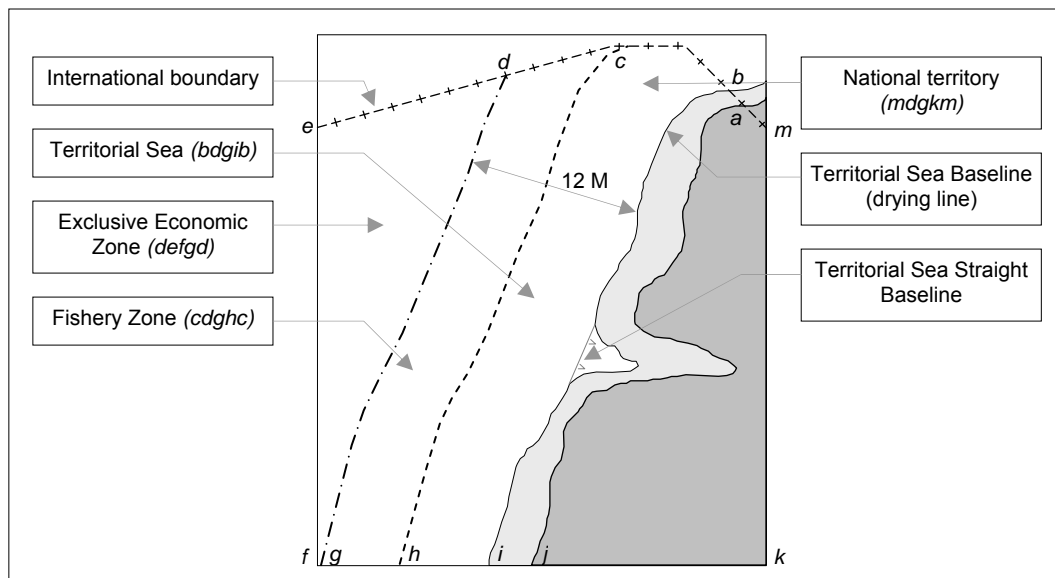

Figure 14 – Maritime jurisdiction areas

Clauses 11.2.1 to 11.2.8 below provide guidance for the encoding of maritime jurisdiction areas. Occasionally, these “areas” may actually be defined as linear due to international treaties, or the areas may not be fully defined and it may therefore be necessary to encode the boundary as a linear feature. Table 3.1 of the ENC Product Specification (S-57 Appendix B.1) defining objects permitted

for use in ENC and their geometric primitives does not allow many of the object classes relating to maritime jurisdiction areas to be encoded as type line.

If it is required to encode a linear maritime jurisdiction feature, it must be done using the corresponding object class as outlined below. If the “line” primitive is not permitted for the related object class, the linear maritime jurisdiction feature should be encoded as a “very narrow area”, and by masking all the edges of the area that are not relevant (i.e. are not along the reference line – see clause 17). **Note that this method must not be used where an area can be defined.**

The “very narrow area” should be an area having an edge corresponding to the reference line and be about 0.2mm in width at ENC compilation scale (see clause 2.2.6). Caution notes for such areas should be encoded using the attributes INFORM and/or TXTDSC.

### 11.2.1 National territories

If it is required to encode a national territory, it must be done using the object class **ADMARE**.

Geo object: Administration area (**ADMARE**) (A)  
 Attributes: JRSDTN - 2 – national.  
 NATION NOBJNM OBJNAM INFORM NINFOM

### 11.2.2 Custom zones

If it is required to encode a custom zone, it must be done using the object class **CUSZNE**.

Geo object: Custom zone (**CUSZNE**) (A)  
 Attributes: NATION INFORM NINFOM

### 11.2.3 Free port areas

If it is required to encode a free port area, it must be done using the object class **FRPARE**.

Geo object: Free port area (**FRPARE**) (A)  
 Attributes: NOBJNM OBJNAM STATUS INFORM NINFOM

### 11.2.4 Territorial Seas

A Territorial Sea is delimited by:

- Territorial Sea Baselines (drying lines);
- Straight Territorial Sea Baselines;
- international maritime boundaries; and
- seaward limits of Territorial Seas.

If it is required to encode the Straight Territorial Sea Baseline, it must be done using the object class **STSLNE**.

Geo object: Straight Territorial Sea Baseline (**STSLNE**) (L)  
 Attributes: NATION INFORM NINFOM

If it is required to encode the Territorial Sea area, it must be done using the object class **TESARE**.

Geo object: Territorial Sea area (**TESARE**) (A)  
 Attributes: NATION RESTRN INFORM NINFOM

In accordance with Article 55 of the United Nations Convention on the Law of the Sea (UNCLOS – 10 December 1982), a Coastal State’s Territorial Sea Area and Exclusive Economic Zone must not overlap. Occasionally, small areas at the boundary of two or more Coastal States may be in dispute regarding the establishment of maritime jurisdiction, which may result in a small section of Territorial Sea overlapping an EEZ in the disputed area.

Where issues of maritime jurisdiction between two or more Coastal States are in dispute, the proposed Territorial Sea (**TESARE**) of one Coastal State may overlap the proposed EEZ (**EXEZNE**) of another Coastal State. In this case, the disputed area should be encoded with overlapping **TESARE** and **EXEZNE** objects, and S-58 (Recommended ENC Validation Checks) test 1700 may be

ignored until the dispute is settled. Where an area is in dispute, a **CTNARE** object should also be encoded covering the entire disputed area, with caution notes advising that the area is in dispute encoded using the attributes **INFORM** and/or **TXTDSC**.

### 11.2.5 Contiguous Zones

If it is required to encode a contiguous zone, it must be done using the object class **CONZNE**.

Geo object: Contiguous Zone (**CONZNE**) (A)  
 Attributes: **DATEND** **DATSTA** **NATION** **STATUS** **INFORM** **NINFOM**

### 11.2.6 Fishery zones

If it is required to encode a fishery zone, it must be done using the object class **FSHZNE**.

Geo object: Fishery zone (**FSHZNE**) (A)  
 Attributes: **NATION** **NOBJNM** **OBJNAM** **STATUS**  
**INFORM** - value and unit of measure of the associated limit (e.g. 6 M or 12 M).  
**NINFOM**

### 11.2.7 Continental Shelves

If it is required to encode a Continental Shelf, it must be done using the object class **COSARE**.

Geo object: Continental Shelf area (**COSARE**) (A)  
 Attributes: **NATION** **NOBJNM** **OBJNAM** **INFORM** **NINFOM**

### 11.2.8 Exclusive Economic Zones

If it is required to encode an Exclusive Economic Zone, it must be done using the object class **EXEZNE**.

Geo object: Exclusive Economic Zone (**EXEZNE**) (A)  
 Attributes: **NATION** **INFORM** **NINFOM**

Remarks:

- For areas of disputed maritime jurisdiction claims containing overlapping **EXEZNE** and **TESARE** objects, see clause 11.2.4.

## 11.3 Military practice areas; submarine transit lanes; minefields

### 11.3.1 Military practice areas (see S-4 – B-441)

If it is required to encode a military practice area, it must be done using the object class **MIPARE**.

Geo object: Military practice area (**MIPARE**) (P,A)  
 Attributes: **CATMPA** **DATEND** **DATSTA** **NOBJNM** **OBJNAM** **PEREND** **PERSTA**  
**RESTRN** **STATUS** **INFORM** **NINFOM**

### 11.3.2 Submarine transit lanes (see S-4 – B-441.5)

If it is required to encode a submarine transit lane, it must be done using the object class **SUBTLN**.

Geo object: Submarine transit lane (**SUBTLN**) (A)  
 Attributes: **NOBJNM** **OBJNAM** **RESTRN** **INFORM** **NINFOM**

### 11.3.3 Minefields (see S-4 – B-441.8)

If it is required to encode a minefield, it must be done using a **RESARE** object (see clause 11.1), with attribute **CATREA** = 14 (minefield). Former mined areas should also be encoded with attribute **STATUS** = 4 (not in use).

## 11.4 Dumping grounds (see S-4 – B-442 and B-446)

If it is required to encode a dumping ground, it must be done using the object class **DMPGRD**.

Geo object: Dumping ground (**DMPGRD**) (P,A)  
 Attributes: CATDPG NOBJNM OBJNAM RESTRN STATUS INFORM NINFOM

## 11.5 Cables and cable areas

### 11.5.1 Submarine cables (see S-4 – B-443)

If it is required to encode a submarine cable, it must be done using the object class **CBLSUB**.

Geo object: Cable, submarine (**CBLSUB**) (L)  
 Attributes: BURDEP - if the buried depth varies along the cable, the cable must be encoded as several objects.  
 CATCBL - 1 - power line.  
 4 - telephone.  
 5 - telegraph.  
 6 - mooring cable/chain.  
 if encoded, the value of CATCBL must be one of the above.  
 CONDTN - 1 - under construction (during laying).  
 5 - planned construction (planned laying).  
 if encoded, the value of CONDTN must be one of the above.  
 DATEND DATSTA DRVAL1 DRVAL2 NOBJNM OBJNAM  
 STATUS - 4 - not in use (disused).  
~~VERDAT~~ INFORM NINFOM

Remarks:

- Where a cable is disused, it should be encoded with the attribute STATUS = 4 (not in use (disused)), and the attribute CATCBL should not be encoded.

### 11.5.2 Overhead cables (see S-4 – B-382)

If it is required to encode an overhead cable, it must be done using the object class **CBLOHD**.

Geo object: Cable, overhead (**CBLOHD**) (L)  
 Attributes: CATCBL  
 CONDTN - 1 - under construction.  
 5 - planned construction.  
 if encoded, the value of CONDTN must be one of the above.  
 CONRAD CONVIS DATEND DATSTA ICEFAC NOBJNM OBJNAM  
 STATUS  
 VERACC - applies only to VERCLR and VERCOSA.  
~~VERCLR~~ ~~VERCSA~~  
~~VERDAT~~ - applies only to VERCLR and VERCOSA.  
 INFORM NINFOM

Remarks:

- If it is required to encode telepheric cables, this must be done using **CONVYR** objects (see clause 4.8.11), with attribute CATCON = 1 (aerial cableway (telepheric)).
- Where a cable has radar reflectors, they must be encoded as separate **RADRFL** objects (see clause 12.12). If the whole cable is radar conspicuous, or the compilation scale is too small to show individual reflectors, the **CBLOHD** should be encoded with attribute CONRAD = 1 (radar conspicuous).

### 11.5.3 Submarine cable areas (see S-4 – B-443.3)

If it is required to encode a submarine cable area, it must be done using the object class **CBLARE**.

Geo object: Cable area (**CBLARE**) (A)  
 Attributes: CATCBL - 1 - power line.  
                   4 - telephone.  
                   5 - telegraph.  
                   If encoded, the value of CATCBL must be one of the above.  
 DATEND DATSTA NOBJNM OBJNAM RESTRN  
 STATUS - used only to encode the status of the area and not the status of the  
                   cables in the area.  
 INFORM NINFOM

## 11.6 Pipelines and pipeline areas

### 11.6.1 Pipelines, submarine or on land (see S-4 – B-377 and B-444)

If it is required to encode a submarine or land pipeline, it must be done using the object class **PIPSOL**.

Geo object: Pipeline, submarine / on land (**PIPSOL**) (P,L)  
 Attributes: BURDEP - if the buried depth varies along the pipeline, the pipeline must be  
                   encoded as several objects.  
 CATPIP  
 CONDTN - 1 - under construction (during laying).  
                   5 - planned construction (planned laying).  
                   if encoded, the value of CONDTN must be one of the above.  
 DATEND DATSTA  
 DRVAL1 - shallowest depth over the pipeline.  
 DRVAL2 - deepest depth over the pipeline.  
 NOBJNM OBJNAM PRODC T  
 STATUS - 4 - not in use (disused).  
 VERACC VERDAT VERLEN INFORM NINFOM

Remarks:

- Where a pipeline is disused, it should be encoded with the attribute STATUS = 4 (not in use (disused)), and the attributes CATPIP and PRODC T should not be encoded.
- **PIPSOL** objects of type point do not display in ECDIS. Encoders wishing to display these objects in ECDIS must consider alternate encoding options (e.g. using **LNDMRK**, **OBSTRN**, **SLCONS**, or encoding a short line-type **PIPSOL** object).

### 11.6.2 Diffusers, cribs

If it is required to encode diffusers and cribs, this must be done using **OBSTRN** objects (see clause 6.2.2), with attribute CATOBS = 3 (diffuser) or 4 (crib).

### 11.6.3 Overhead pipelines (see S-4 – B-383)

If it is required to encode an overhead pipeline passing over or nearby navigable waters, it must be done using the object class **PIPOHD**.

Geo object: Pipeline overhead (**PIPOHD**) (L)  
 Attributes: CATPIP  
 CONDTN - 1 - under construction.  
                   5 - planned construction.  
                   if encoded, the value of CONDTN must be one of the above.  
 CONRAD CONVIS DATEND DATSTA NOBJNM OBJNAM PRODC T  
 STATUS  
 VERACC - applies only to VERCLR.  
 VERCLR  
 VERDAT - applies only to VERCLR.  
 INFORM NINFOM

## Remarks:

- Where an overhead pipeline is disused, it should be encoded with the attribute STATUS = 4 (not in use (disused)), and the attributes CATPIP and PRODCAT should not be encoded.

**11.6.4 Pipeline areas (see S-4 – B-444.3)**

If it is required to encode a pipeline area, it must be done using the object class **PIPARE**.

Geo object: Pipeline area (**PIPARE**) (P,A)  
 Attributes: CATPIP CONDITN DATEND DATSTA NOBJNM OBJNAM PRODCAT  
 RESTRN  
 STATUS - used only to encode the status of the area and not the status of the pipelines in the area.  
 INFORM NINFOM

**11.7 Oil and Gas fields (see S-4 – B-445)****11.7.1 Wellheads (see S-4 – B-445.1)**

If it is required to encode wellheads, this must be done using **OBSTRN** objects of type point (see clause 6.2.2), with attributes:

CATOBS - 2 – wellhead.  
 HEIGHT  
 STATUS - 4 - not in use (disused).  
 VALSOU  
 VERLEN - vertical length of the wellhead above the seabed.  
WATLEV - 2 - always dry (for wellheads that protrude at high water).  
 3 - always under water/submerged.

**11.7.2 Offshore platforms (see S-4 – B-445.2; B-445.4 and B-445.5)**

If it is required to encode a permanent offshore platform (fixed or floating), it must be done using the object class **OFSPLF**.

Geo object: Offshore platform (**OFSPLF**) (P,A)  
 Attributes: CATOFP COLOUR COLPAT CONDTN CONRAD CONVIS DATEND  
 DATSTA  
 HEIGHT - for fixed platforms, referred to the vertical datum (see clause 2.1.2).  
 NATCON NOBJNM OBJNAM PRODCAT STATUS VERACC VERDAT  
 VERLEN - for floating platforms, referred to the sea level.  
 INFORM NINFOM

## Remarks:

- The S-57 definition for attribute value CATOFP = 8 (floating production, storage and offloading vessel (FPSO)) should be interpreted as any offshore facility consisting of a moored vessel by which the product is extracted, stored or exported.
- If it is required to encode sites of dismantled platforms, this must be done using **OBSTRN** objects (see clause 6.2.2), with attribute CATOBS = 7 (foul ground).
- Platforms may carry lights (see clause 12.8), fog signals (see clause 12.5) and helicopter platforms (see clause 4.8.12).

**11.7.3 Offshore safety zones (see S-4 – B-445.6)**

If it is required to encode an offshore safety zone, it must be done using a **RESARE** object (see clause 11.1), with attribute CATREA = 1 (offshore safety zone).

**11.7.4 Offshore production areas (see S-4 – B-445.3; B-445.9; B-445.11 and B-445.12)**

If it is required to encode an offshore production area, it must be done using the object class **OSPARE**.

Geo object: Offshore production area (**OSPARE**) (A)  
 Attributes: CATPRA CONDTN CONRAD CONVIS DATEND DATSTA HEIGHT  
 INFORM NINFOM NOBJNM OBJNAM PRODCT RESTRN STATUS  
 VERACC VERLEN

## Remarks:

- If it is required to encode an offshore wind farm, it should be done using an **OSPARE** object, with attribute CATPRA = 9 (wind farm). General information about the wind farm such as blade diameter and blade vertical clearance should be encoded, if required, using the attributes INFORM or TXTDSC. If it is required to encode individual offshore wind turbines, it should be done using a **LNDMRK** object of type point (see clause 4.8.15), with attribute CATLMK = 19 (windmotor). Where a **LNDMRK** is encoded, an ECDIS Base Display object (e.g. **PILPNT**, **LNDARE**) must also be encoded coincident to ensure the feature is always displayed on the ECDIS. Where fitted, lights should be encoded as described in clause 12.8, with the **LNDMRK** being used as the structure object for the **LIGHTS** equipment object(s) (see clause 12.1.1). The extent and nature of any restricted area related to the wind turbine should be encoded using a **RESARE** object (see clause 11.1).
- If it is required to encode a wave or current farm (or turbine field) for generating electricity from waves or tidal currents, it should be done using an **OSPARE** object, with no value populated for CATPRA and attribute INFORM = *Wave farm* or *Current farm*. If it is required to encode individual wave energy devices or underwater turbines, it should be done using an **OBSTRN** object (see clause 6.2.2) or, if there are associated surface structures, using appropriate object classes, e.g. **OFSPLF** or **BCNSPP** (see clauses 11.7.2 and 12.3.1), with attribute INFORM = *Wave energy device* or *Underwater turbine*. The extent and nature of any restricted area related to the feature should be encoded using a **RESARE** object (see clause 11.1).

**11.7.5 Offshore tanker loading systems (see S-4 – B-445.4)**

If it is required to encode an offshore tanker loading system, it must be done using the object class **BOYINB** (see clause 12.4.1).

If it is required to encode an articulated tower, it must be done using an **OFSPLF** object (see clause 11.7.2), with attribute:

CATOFFP - 4 - articulated loading platform (ALP).  
 5 - single anchor leg mooring (SALM).  
 8 - floating production, storage and off-loading vessel (FPSO).  
 10 - navigation, communication and control buoy (NCCB) (which may include storage facilities).

**11.7.6 Flare stacks (see S-4 – B-445.2)**

If it is required to encode a flare stack, it must be done using a **LNDMRK** object (see clause 4.8.15), with attribute CATLMK = 6 (flare stack).

An offshore flare stack may share the same geometry as the platform on which it is installed.

**11.8 Spoil grounds, dredging areas (see S-4 – B-446)**

If it is required to encode a spoil ground, it must be done using a **DMPGRD** object (see clause 11.4), with attribute CATDPG = 5 (spoil ground).

If it is required to encode a dredging area, it must be done using a **RESARE** object (see clause 11.1), with attribute CATREA = 21 (dredging area).

**11.9 Fishing equipment and aquaculture areas****11.9.1 Fishing facilities (see S-4 – B-447.1 to B-447.3)**

If it is required to encode a fishing facility, including those that may be in deep water, it must be done using the object class **FSHFAC**.

Geo object: Fishing facility (**FSHFAC**) (P,L,A)  
 Attributes: CATFIF NOBJNM OBJNAM PEREND PERSTA STATUS VERACC  
 VERLEN - height of the object above the seabed.  
 INFORM NINFOM

## Remarks:

- Certain types of fishing facilities such as tunny nets in deep water may be an obstruction to navigation. If **FSHFAC** features are considered to be an obstruction or hazard to navigation, they should also be encoded with an **OBSTRN** object (see clause 6.2.2). Although this is contrary to ENC encoding principles (i.e. double encoding), this solution is recommended for portraying dangers to navigation of this nature in the ECDIS.

**11.9.2 Marine farms (see S-4 – B-447.4 and B-447.6)**

If it is required to encode a marine farm, it must be done using the object class **MARCUL**.

Geo object: Marine farm / culture (**MARCUL**) (P,L,A)  
 Attributes: CATMFA DATEND DATSTA EXPSOU NOBJNM OBJNAM PEREND  
 PERSTA QUASOU RESTRN SOUACC STATUS VALSOU VERDAT  
 VERLEN - height of the object above the seabed.  
WATLEV INFORM NINFOM

## Remarks:

- When it is required to encode the minimum depth of the object, the attributes EXPSOU and QUASOU and the mandatory attribute VALSOU must be used. When a **MARCUL** object covers an area of the seafloor at the compilation scale of the ENC, the value of the attribute VALSOU represents the minimum depth, if known, over any structure used to form or support the marine farm, or within the area of the marine farm itself. The mandatory attribute WATLEV must be used to encode the water level of the shallowest section of the area, if partly or completely under water.
- Where required, ground tackle associated with marine farms must be encoded as **OBSTRN** objects (see clause 6.2.2).

**11.9.3 Fish havens (see S-4 – B-447.5)**

If it is required to encode a fish haven, it must be done using an **OBSTRN** object (see clause 6.2.2), with attribute CATOBS = 5 (fish haven).

**11.9.4 Fishing grounds**

If it is required to encode a fishing ground, it must be done using the object class **FSHGRD**.

Geo object: Fishing ground (**FSHGRD**) (A)  
 Attributes: NOBJNM OBJNAM PEREND PERSTA STATUS INFORM NINFOM

**11.10 Degaussing ranges (see S-4 – B-448)**

If it is required to encode a degaussing range, it must be done using a **RESARE** object (see clause 11.1), with attribute CATREA = 8 (degaussing range).

**11.11 Historic wrecks (see S-4 – B-422)**

If it is required to encode a restricted area around a historic wreck, it must be done using a **RESARE** object (see clause 11.1), with attribute CATREA = 10 (historic wreck area).

In addition, the wreck itself should be encoded as a **WRECKS** object (see clause 6.2.1), with attribute STATUS = 13 (historic).

**11.12 Seaplane landing areas (see S-4 – B-449.6)**

If it is required to encode a seaplane landing area, it must be done using the object class **SPLARE**.



Geo object: Seaplane landing area (**SPLARE**) (P,A)  
 Attributes: NOBJNM OBJNAM PEREND PERSTA RESTRN STATUS INFORM  
 NINFOM

Remarks:

- If it is required to encode an anchorage for seaplanes, it must be done using an **ACHARE** object (see clause 9.2.1), with attribute CATACH = 6 (seaplane anchorage).

## 11.13 Various maritime areas

### 11.13.1 Ice areas (see S-4 – B-353.8 and B-449.1)

If it is required to encode an ice area, it must be done using the object class **ICEARE**.

Geo object: Ice area (**ICEARE**) (A)  
 Attributes: CATICE CONVIS ELEVAT HEIGHT NOBJNM OBJNAM PEREND  
 PERSTA STATUS ~~VERACC~~ ~~VERDAT~~ VERLEN INFORM NINFOM

### 11.13.2 Log ponds (see S-4 – B-449.2)

If it is required to encode a log pond, it must be done using the object class **LOGPON**.

Geo object: Log pond (**LOGPON**) (P,A)  
 Attributes: NOBJNM OBJNAM STATUS INFORM NINFOM

### 11.13.3 Incineration areas (see S-4 – B-449.3)

If it is required to encode an incineration area, it must be done using the object class **ICNARE**.

Geo object: Incineration area (**ICNARE**) (P,A)  
 Attributes: NOBJNM OBJNAM PEREND PERSTA RESTRN STATUS INFORM  
 NINFOM

### 11.13.4 Cargo transshipment areas (see S-4 – B-449.4)

If it is required to encode a cargo transshipment area, it must be done using the object class **CTSARE**.

Geo object: Cargo transshipment area (**CTSARE**) (P,A)  
 Attributes: DATEND DATSTA NOBJNM OBJNAM PEREND PERSTA STATUS  
 INFORM NINFOM

### 11.13.5 Collision regulations

Some nations have introduced collision regulations (COLREG's) that may include demarcation lines differentiating between inland water rules and International Rules as a result of the Convention on the International Regulations for Preventing Collisions at Sea 1972. If it is required to encode COLREG's, it should be done using a narrow **CTNARE** object of type area (see clause 6.6) covering the demarcation line, with attribute INFORM and/or TXTDSC containing a short explanation about the regulation, (e.g. cautionary note from the paper chart). The attribute TXTDSC may be used instead of INFORM, or for longer explanations or notes.

## 11.14 Nature reserves (see S-4 – B-437.3)

If it is required to encode a marine nature reserve area, it must be done using a **RESARE** object (see clause 11.1), with attribute CATREA = 4 (nature reserve). A nature reserve that is shown on the source as a point symbol should be encoded using a **CTNARE** object of type point, with the attribute INFORM = *Marine nature reserve*.

## 11.15 Environmentally Sensitive Sea Areas (see S-4 – B-437)

If it is required to encode an Environmentally Sensitive Sea Area, it must be done using a **RESARE** object (see clause 11.1), with attribute CATREA = 27 (ESSA) or 28 (PSSA).

An Environmentally Sensitive Sea Area that is shown on the source as a point symbol should be encoded using a small area **RESARE** object.

## 12 Aids to navigation

### 12.1 Lighthouses, navigational marks - relationships

#### 12.1.1 Geo objects forming parts of navigational aids

Aids to navigation are composed of fixed or floating structures carrying equipment objects.

The most common structure objects are: **BCNCAR**, **BCNISD**, **BCNLAT**, **BCNSAW**, **BCNSPP**, **BOYCAR**, **BOYINB**, **BOYISD**, **BOYLAT**, **BOYSAW**, **BOYSPP**, **BRIDGE**, **BUISGL**, **CRANES**, **DAYMAR**, **FLODOC**, **FORSTC**, **FSHFAC**, **HULKES**, **LITFLT**, **LITVES**, **LNDMRK**, **MORFAC**, **OFSPLF**, **PILPNT**, **PONTON**, **PYLONS**, **OBSTRN**, **SILTNK**, **SLCONS**, **WRECKS**.

Equipment objects consist of: **DAYMAR**, **FOGSIG**, **LIGHTS**, **RADSTA**, **RDESTA**, **RETRFL**, **RTPBCN**, **SISTAT**, **SISTAW**, **TOPMAR**.

Radar reflectors must not be encoded as separate objects when attached to navigational aids. If it is required to encode their existence, it must be done using the attribute **CONRAD = 3** (radar conspicuous (has radar reflector)) on the structure object.

Rescue stations and coastguard stations are not related directly to navigation, and they must not, therefore, be part of the equipment objects of navigational aids. If it is required to encode a rescue or coastguard station at the same location as a navigational mark, it must be encoded as a separate object, and share the same spatial object as the navigational aid.

#### 12.1.2 Relationships

A master to slave relationship must be created in order to relate the different objects comprising a navigational aid. Where a master to slave relationship is created, there must be only one master (structure) object related to one or more slave (equipment) objects. A slave object must not be related to more than one master object, and an object must not be both a master and a slave object.

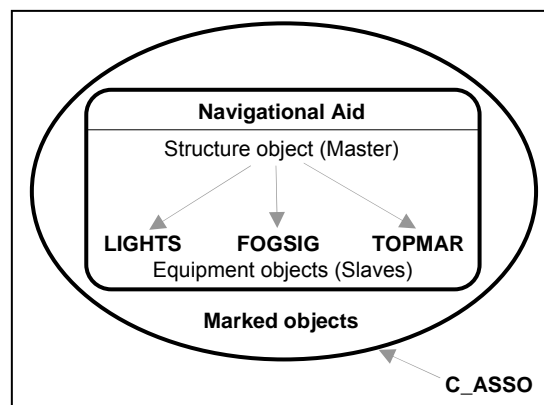

Figure 15 – Navigational aids

When the navigational aid contains a structure object (from the list at clause 12.1.1), this object must be the master object, and the equipment objects must be the slaves. Note that **DAYMAR** may be a master object or a slave object; where a navigational aid contains a **DAYMAR** and there is no other base structure (which can serve as the master object) indicated on the **DAY** source, the **DAYMAR** object should be encoded as the master object.

When the nature of the base structure on land is unknown or there is no structure object, one of the equipment objects must be chosen as the master object, giving priority to a **LIGHTS** object, if one exists. Alternatively, a **PILPNT** object of type point or a **BCNSPP** object may be encoded as the structure object at the same position as the equipment objects. When the nature of the base structure in the water is unknown, an ECDIS Base or Standard Display object (see S-52, Annex A, clause

13.2), e.g. **PILPNT** object of type point or a **BCNSPP** object, must be encoded as the structure object at the same position as the equipment objects.

If it is required to encode the name of the navigational aid, it must be done using the attribute OBJNAM (and possibly the attribute NOBJNM) on the master object. The name should not be repeated for the slave objects. If the name is painted on the structure, it must be encoded with the same spelling in OBJNAM if it is based on the Latin alphabet. If the name is not based on the Latin alphabet, it must be encoded on NOBJNM, and transliterated for encoding on OBJNAM.

All point objects comprising a navigational aid must point to the same point spatial object.

The navigational aid may be associated with the objects which it marks (e.g. **RESARE** or **OBSTRN** objects) using the collection object **C\_ASSO** (see clause 15). Several navigational aids and several marked objects may be associated in the same relationship.

## 12.2 Buoyage systems and direction of buoyage (see S-4 – B-461)

The buoyage system of the data set and, where necessary, the direction of buoyage, must be encoded using the meta object **M\_NSYS**:

Meta object: Navigational system of marks (**M\_NSYS**) (A)  
 Attributes: MARSYS ORIENT INFORM NINFOM

All parts of the data set containing data must be covered by **M\_NSYS** objects, with the attribute MARSYS indicating the buoyage system in operation. **M\_NSYS** with a value encoded for MARSYS must not overlap.

In the following table the symbol '/' indicates that this attribute is not relevant for that particular object class. The table contains the most common examples of coding; other coding combinations are possible. For encoding of buoys, substitute BOY for BCN in Object class.

Feature	INT 1	Object class	Defining attribute value *	COLOUR	COLPAT	MARSYS
North cardinal beacon	Q130.3	<b>BCNCAR</b>	1	2,6	1	1 or 2 (IALA A or B)
East cardinal beacon	Q130.3	<b>BCNCAR</b>	2	2,6,2	1	1 or 2 (IALA A or B)
South cardinal beacon	Q130.3	<b>BCNCAR</b>	3	6,2	1	1 or 2 (IALA A or B)
West cardinal beacon	Q130.3	<b>BCNCAR</b>	4	6,2,6	1	1 or 2 (IALA A or B)
Isolated danger beacon	Q130.4	<b>BCNISD</b>	/	2,3,2	1	1 or 2 (IALA A or B)
Port lateral beacon	Q130.1	<b>BCNLAT</b>	1	3	/	1 (IALA A)
Starboard lateral beacon	Q130.1	<b>BCNLAT</b>	2	4	/	1 (IALA A)
Preferred channel to starboard lateral beacon	Q130.1	<b>BCNLAT</b>	3	3,4,3	1	1 (IALA A)
Preferred channel to port lateral beacon	Q130.1	<b>BCNLAT</b>	4	4,3,4	1	1 (IALA A)
Port lateral beacon	Q130.1	<b>BCNLAT</b>	1	4	/	2 (IALA B)
Starboard lateral beacon	Q130.1	<b>BCNLAT</b>	2	3	/	2 (IALA B)
Preferred channel to starboard lateral beacon	Q130.1	<b>BCNLAT</b>	3	4,3,4	1	2 (IALA B)
Preferred channel to port lateral beacon	Q130.1	<b>BCNLAT</b>	4	3,4,3	1	2 (IALA B)

Feature	INT 1	Object class	Defining attribute value *	COLOUR	COLPAT	MARSYS
Safe water beacon	Q130.5	BCNSAW	/	3,1 or 1,3	2	1 or 2 (IALA A or B)
Special purpose beacon	Q130.6	BCNSPP	/	6	/	1 or 2 (IALA A or B)
Emergency wreck marking buoy		BOYSPP	27	5,6	2	1 or 2 (IALA A or B)
North cardinal topmark	Q130.3	TOPMAR	13	2	/	1 or 2 (IALA A or B)
East cardinal topmark	Q130.3	TOPMAR	11	2	/	1 or 2 (IALA A or B)
South cardinal topmark	Q130.3	TOPMAR	14	2	/	1 or 2 (IALA A or B)
West cardinal topmark	Q130.3	TOPMAR	10	2	/	1 or 2 (IALA A or B)
Isolated danger topmark	Q130.4	TOPMAR	4	2	/	1 or 2 (IALA A or B)
Port lateral topmark	Q130.1	TOPMAR	5	3	/	1 (IALA A)
Starboard lateral topmark	Q130.1	TOPMAR	1	4	/	1 (IALA A)
Port lateral topmark	Q130.1	TOPMAR	5	4	/	2 (IALA B)
Starboard lateral topmark	Q130.1	TOPMAR	1	3	/	2 (IALA B)
Safe water topmark	Q130.1	TOPMAR	3	3	2	1 or 2 (IALA A or B)
Special purpose topmark	Q130.1	TOPMAR	7	6	/	1 or 2 (IALA A or B)
Emergency wreck marking topmark		TOPMAR	8	6	/	1 or 2 (IALA A or B)

table 12.1

\* For cardinal marks, the defining attribute is CATCAM. For lateral marks, the defining attribute is CATLAM. For special purpose marks, the defining attribute is CATSPM. For topmarks, the defining attribute is TOPSHP.

Within a data set, there may be some areas where the direction of buoyage is defined by local rules and must, therefore, be specified. These areas should be encoded as separate **M\_NSYS** area objects, with the attribute ORIENT indicating the direction of buoyage (MARSYS must not be encoded). **M\_NSYS** objects with a value encoded for ORIENT must not overlap, but in areas where local buoyage directions apply, **M\_NSYS** with a value encoded for ORIENT may overlap **M\_NSYS** with a value encoded for MARSYS (see Figure 16 below).

Individual buoys and beacons may not be part of the general buoyage system. This should be encoded using MARSYS on these buoy and beacon objects.

Remarks:

- If it is required to indicate that direction of buoyage is based on a named system other than IALA A or B (e.g. SIGNI), this should be done using **M\_NSYS**, with MARSYS = 10 (other system) and attribute INFORM populated with the name of the buoyage system (e.g. *SIGNI*).

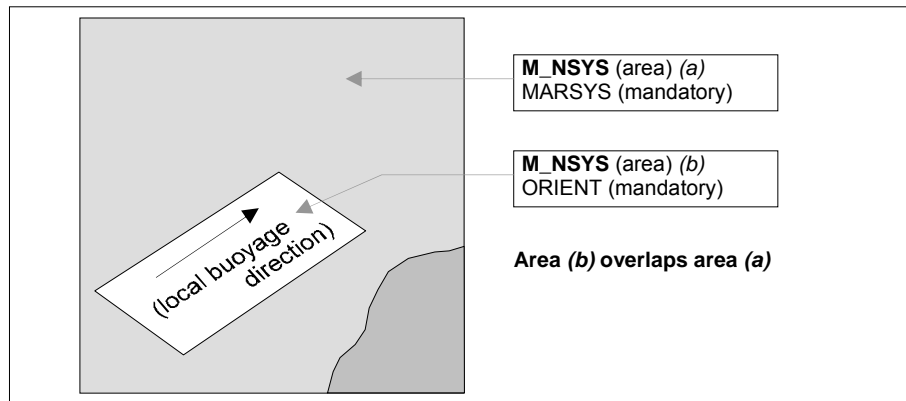

Figure 16 – Buoyage system and direction

## 12.3 Fixed structures (see S-4 – B-455)

### 12.3.1 Beacons

If it is required to encode a beacon, it must be done using the object classes **BCNCAR**, **BCNISD**, **BCNLAT**, **BCNSAW** or **BCNSPP**.

Geo objects: Beacon, cardinal (**BCNCAR**) (P)  
 Beacon, isolated danger (**BCNISD**) (P)  
 Beacon, lateral (**BCNLAT**) (P)  
 Beacon, safe water (**BCNSAW**) (P)  
 Beacon, special purpose (**BCNSPP**) (P)

Attributes: BCNSHP  
CATCAM - only for **BCNCAR**.  
CATLAM - only for **BCNLAT**.  
CATSPM - only for **BCNSPP**.  
COLOUR COLPAT CONDTN CONRAD CONVIS DATEND DATSTA  
ELEVAT HEIGHT  
MARSYS - only if different to the value encoded on meta object **M\_NSYS**.  
NATCON NOBJNM OBJNAM PEREND PERSTA STATUS VERAGG  
VERDAT VERLEN INFORM NINFOM

#### Remarks:

- If it is required to encode the altitude of the ground level above the vertical datum at the position of a beacon, it must be done using the attribute ELEVAT, but only for beacons built on land.
- If it is required to encode the total altitude of a beacon, including any equipment objects (e.g. topmark, light), above the vertical datum, it must be done using the attribute HEIGHT.
- If it is required to encode the total vertical length of a beacon, including any equipment objects (e.g. topmark, light), above the seabed or ground, it must be done using the attribute VERLEN.
- The S-57 definition for the attribute value BCNSHP = 1 (stake, pole, perch, post) implies that stakes, poles, perches and posts must be embedded in the water. Encoders should note that stakes, poles, perches or posts may also exist on land, and where this is the case, they should be encoded using the relevant beacon object class.
- If it is required to encode a cairn that bears the colour(s) specified by a navigational system of marks, it must be done using a beacon object.
- If it is required to encode a beacon that has more than one colour, the attributes COLOUR and COLPAT must be encoded, according to the rules laid out in clause 2.4.

In the following table, the symbol '/' indicates that this attribute does not exist for that particular object class. A blank indicates that the encoder may choose a relevant value for the attribute. The table contains the most common examples of coding; other coding combinations are possible.

Feature	INT1	Object-class	BCNSHP	CATSPM	Other attributes
Minor not permanent mark	Q90	<b>BCN***</b>	1		
	Q91	<b>BCNLAT</b>	1	/	
	Q92	<b>BCNLAT</b>	2	/	
Cairn	Q100	<b>BCN***</b>	6		
Coloured or white mark	Q101	<b>DAYMAR</b>	/		NATCON = 9
Coloured topmark with function of beacon	Q102.1	<b>DAYMAR</b>	/		NATCON = 9
Painted board with function of leading beacon	Q102.2	<b>DAYMAR</b>	/	16	NATCON = 9 TOPSHP = 6
Beacon tower	Q110	<b>BCN***</b>	3		
Lattice beacon	Q111	<b>BCN***</b>	4		
Leading beacon	Q120	<b>BCNSPP</b>		16	
Beacon marking a clearing line	Q121	<b>BCNSPP</b>		41	
Beacon marking measured distance	Q122	<b>BCNSPP</b>		17	
Cable landing beacon	Q123	<b>BCNSPP</b>		6	
Outfall landing beacon	Q123	<b>BCNSPP</b>		8	
Pipeline landing beacon	Q123	<b>BCNSPP</b>		39	
Refuge beacon	Q124	<b>BCNSPP</b>		44	
Firing practice area beacon	Q125	<b>BCNSPP</b>		1	
Notice board	Q126	<b>BCNSPP</b>		18	
Buoyant beacon	P5	<b>BCN***</b>	7		

table 12.2

### 12.3.2 Lighthouses (see S-4 – B-457.3)

If it is required to encode a lighthouse, it must be done using a **LNDMRK** object (see clause 4.8.15), with attributes CATLMK = 17 (tower) and FUNCTN = 33 (light support) for towers, or using a **BUISGL** object (see clause 4.8.15), with the attribute FUNCTN = 33, for any other shapes.

If it is required to encode the attributes ELEVAT, HEIGHT and VERLEN for a lighthouse, this must be done as described in clause 12.3.1.

If the lighthouse is permanently extinguished/unlit, this must be indicated by population of the attribute STATUS = 4 (not in use) for the **LNDMRK/BUISGL**, and the **LIGHTS** object(s) must be removed. Where a lighthouse is illuminated by floodlights, the additional value of STATUS = 12 (illuminated) must also be populated. For lights that are temporarily extinguished, see clause 2.6.2.2 – paragraph 10(i).

### 12.3.3 Daymarks

If it is required to encode a daymark, it must be done using the object class **DAYMAR**.

Geo object: Daymark (**DAYMAR**) (P)  
 Attributes: CATSPM COLOUR COLPAT DATEND DATSTA ELEVAT HEIGHT  
 NATCON NOBJNM OBJNAM PEREND PERSTA STATUS TOPSHP  
 VERACC VERDAT VERLEN INFORM NINFOM

Remarks:

- If it is required to encode the attributes ELEVAT, HEIGHT and VERLEN for a daymark, this must be done as described in clause 12.3.1.

## 12.4 Floating structures (see S-4 – B-460)

### 12.4.1 Buoys

If it is required to encode a buoy, it must be done using the object classes **BOYCAR**, **BOYINB**, **BOYISD**, **BOYLAT**, **BOYSAW** or **BOYSPP**.

Geo objects: Buoy, cardinal (**BOYCAR**) (P)  
 Buoy, installation (**BOYINB**) (P)  
 Buoy, isolated danger (**BOYISD**) (P)  
 Buoy, lateral (**BOYLAT**) (P)  
 Buoy, safe water (**BOYSAW**) (P)  
 Buoy, special purpose (**BOYSPP**) (P)

Attributes: BOYSHP  
CATCAM - only for **BOYCAR**.  
CATINB - only for **BOYINB**.  
CATLAM - only for **BOYLAT**.  
CATSPM - only for **BOYSPP**.  
COLOUR COLPAT CONRAD DATEND DATSTA  
 MARSYS - only if different to the value encoded on meta object **M\_NSYS**.  
 NATCON NOBJNM OBJNAM PEREND PERSTA  
 PRODC T - only for **BOYINB**.  
 STATUS VERAGC VERLEN INFORM NINFOM

#### Remarks:

- If it is required to encode the total vertical length, including any equipment objects (e.g. topmark, light), of the buoy above the water level, it must be done using the attribute VERLEN.
- If it is required to encode a buoy that has more than one colour, the attributes COLOUR and COLPAT must be encoded, according to the rules laid out in clause 2.4.

In the following table, the symbol '/' indicates that this attribute does not exist for that particular object class. A blank indicates that the encoder may choose a relevant value for the attribute. The table contains the most common examples of coding; other coding combinations are possible.

Feature	INT1	Object-class	BOYSHP	CATSPM	Other attributes
Mooring buoy	Q40	<b>MORFAC</b>		/	CATMOR = 7
Oil or gas installation buoy	L16	<b>BOYINB</b>	7	/	PRODC T = 1 or 2 CATINB = 1 or 2
Firing danger area buoy	Q50	<b>BOYSPP</b>		1	
Target	Q51	<b>BOYSPP</b>		2	
Marker ship	Q52	<b>BOYSPP</b>		3	
Barge	Q53	<b>BOYSPP</b>		5	
Degaussing range buoy	Q54	<b>BOYSPP</b>		4	
Buoy marking cable	Q55	<b>BOYSPP</b>		6	
Spoil ground buoy	Q56	<b>BOYSPP</b>		7	
Buoy marking outfall	Q57	<b>BOYSPP</b>		8	
Buoy marking pipeline		<b>BOYSPP</b>		39	
Emergency wreck marking buoy		<b>BOYSPP</b>	4 or 5	27	COLOUR = 5,6 COLPAT = 2
Superbuoy	Q26	<b>BOY***</b>	7		
Large automatic navigational buoy	P6	<b>BOYSPP</b>	7	15	
Data-collecting buoy	Q58	<b>BOYSPP</b>		9	



Feature	INT1	Object-class	BOYSHP	CATSPM	Other attributes
Buoy marking wave recorder (or current meter)	Q59	<b>BOYSPP</b>		10	INFORM = wave recorder (e.g.)
Seaplane anchorage buoy	Q60	<b>BOYSPP</b>		11	
Buoy marking traffic separation scheme	Q61	<b>BOYSPP</b>		19	
Buoy marking recreation zone	Q62	<b>BOYSPP</b>		12	
Floating waste bin		<b>BOYSPP</b>		Empty (null) value	INFORM = waste bin (e.g.)
Subsurface data acquisition buoy		<b>OBSTRN</b>	/	/	VALSOU = depth of subsurface buoy WATLEV = 3 INFORM = ODAS

table 12.3

#### 12.4.1.1 Emergency wreck marking buoys (see S-4 – B-461.3)

If it is required to encode an emergency wreck marking buoy, it must be done using a **BOYSPP** object, with attribute CATSPM = 27 (general warning mark). Further attribution of the object, including any equipment objects, must correspond to the real-world feature. An IALA compliant emergency wreck marking buoy must have attributes BOYSHP = 4 (pillar) or 5 (spar), COLOUR = 5,6 (blue, yellow) and COLPAT = 2 (vertical stripes). The buoy must also have (where fitted) the following accompanying equipment objects encoded:

- A **LIGHTS** object, with attributes COLOUR = 5,6 (blue, yellow), LITCHR = 17 (occulting alternating), SIGGRP = (1) and SIGPER = 3. The attribute SIGSEQ should be populated as 1.00+(0.50)+1.00+(0.50) and the attribute VALNMR should be populated as 4.
- A **TOPMAR** object, with attribute TOPSHP = 8 (upright cross (St George's cross)). The attribute COLOUR should be populated as 6 (yellow).
- A **RTPBCN** object, with attributes CATRTB = 2 (racon, radar transponder beacon) and SIGGRP = (D).

#### 12.4.2 Light floats and light vessels (see S-4 – B-462.8)

If it is required to encode a light float or a light vessel, it must be done using the object class **LITFLT** or **LITVES**.

Geo objects: Light float (**LITFLT**) (P)  
Light vessel (**LITVES**) (P)

Attributes: COLOUR COLPAT CONRAD CONVIS DATEND DATSTA HORACC  
HORLEN HORWID NATCON NOBJNM OBJNAM PEREND PERSTA  
STATUS VERACC VERLEN INFORM NINFOM

#### 12.5 Fog signals (see S-4 – B-451 to B-454)

If it is required to encode a fog signal, it must be done using the object class **FOGSIG**.

Geo object: Fog signal (**FOGSIG**) (P)

Attributes: CATFOG DATEND DATSTA NOBJNM OBJNAM PEREND PERSTA  
SIGFRQ SIGGEN SIGGRP SIGPER SIGSEQ STATUS VALMXR  
INFORM NINFOM

Remarks:

- Where required, the attribute SIGFRQ must be quoted in Hertz, e.g. a signal frequency of 950 MHz must be encoded as 950000000.

## 12.6 Topmarks (see S-4 – B-463)

If it is required to encode a topmark, it must be done using the object class **TOPMAR**.

Geo object: Topmark (**TOPMAR**) (P)  
 Attributes: COLOUR COLPAT DATEND DATSTA ~~HEIGHT~~  
~~MARSYS~~ - the value is given on meta object **M\_NSYS** or MARSYS for the structure object.  
 PEREND PERSTA STATUS TOPSHP ~~VERACC~~ ~~VERDAT~~ ~~VERLEN~~  
 INFORM NINFOM

## 12.7 Retroreflectors (see S-4 – B-460.7)

If it is required to encode a retroreflector, it must be done using the object class **RETRFL**.

Geo object: Retroreflector (**RETRFL**) (P)  
 Attributes: COLOUR COLPAT DATEND DATSTA HEIGHT  
~~MARSYS~~ - the value is given on meta object **M\_NSYS** or MARSYS for the structure object.  
 PEREND PERSTA STATUS ~~VERACC~~ ~~VERDAT~~  
 INFORM - describes letters, patterns or numerals shown on the retroreflector.  
 NINFOM

## 12.8 Lights (see S-4 – B-470)

If the actual structure that supports a light in a water area is unknown, a **PILPNT** object with no attributes should also be encoded at the same position as the light.

### 12.8.1 Description of lights

If it is required to encode a light and its sectors, each sector of the light must be encoded using one separate **LIGHTS** object. These objects must be slave objects of the same master object, which is either the structure object or one of the **LIGHTS**, so that the relationship between them is indicated using the master/slave relationship mechanism described in clause 12.1.2.

Geo object: Light (**LIGHTS**) (P)  
 Attributes: CATLIT - mandatory for air obstruction and fog detector lights.  
COLOUR - mandatory except for air obstruction and fog detector lights.  
 DATEND DATSTA EXCLIT  
 HEIGHT - prohibited for floating lights.  
LITCHR - mandatory except for air obstruction and fog detector lights.  
 LITVIS MARSYS MLTYLT NOBJNM OBJNAM  
ORIENT - prohibited, except for directional or moiré effect lights.  
 PEREND PERSTA  
SECTR1 - prohibited for all-around lights unless obscured or partially obscured.  
SECTR2 - prohibited for all-around lights unless obscured or partially obscured.  
SIGGRP - prohibited for fixed lights.  
SIGPER - prohibited for fixed lights.  
SIGSEQ - prohibited for fixed lights.  
 STATUS VALNMR ~~VERACC~~  
 VERDAT - applies only to HEIGHT; this must only be encoded if it is different to the value encoded in the VDAT subfield of the Data Set Parameter (DSPM) field, or different to the value of VERDAT encoded on meta object **M\_VDAT**.  
 INFORM NINFOM

Remarks:

- If it is required to encode details of the lighting technology (e.g. neon), it must be done using the attribute INFORM.
- If it is required to encode the purpose of a marine spotlight, it must be done using INFORM.

- For lights, the allowable values for the attribute COLOUR are 1 (white); 3 (red); 4 (green); 5 (blue); 6 (yellow); 9 (amber); 10 (violet); 11 (orange); and empty (null) value.
- The S-57 definition for attribute value LITCHR = 28 (alternating) is not consistent with the existing IALA definition and should be read as follows: “a signal light that shows continuously, in any given direction, two or more colours in a regularly repeated sequence with a regular periodicity”.
- For purposes of consistency with the IHO and IALA dictionaries, the meaning for attribute values LITCHR = 13, 14, 15, and 16 should be read as follows:
 

LITCHR = 13 (fixed/flash)	Fixed and flashing;
LITCHR = 14 (fixed/long flash)	Fixed and long flashing;
LITCHR = 15 (occulting/flash)	Occulting and flashing;
LITCHR = 16 (occulting/long flash)	Occulting and long flashing.

### 12.8.2 Types and functions of lights (see S-4 – B-471.1)

If it is required to encode types and functions of lights, this must be done using the attribute CATLIT.

### 12.8.3 Rhythms of lights (see S-4 – B-471.2)

If it is required to encode the rhythms of lights, this must be done using the attributes LITCHR and SIGGRP.

The use of these attributes is defined in the following table; it contains the most common examples of coding; other coding combinations are possible:

Rhythms of lights	F	Oc	Oc(2)	Oc(2+3)	Iso	FI	FI(3)	LFI
LITCHR	1	8	8	8	7	2	2	3
SIGGRP	prohibited	(1)	(2)	(2+3)	(1)	(1)	(3)	(1)

Rhythms of lights	Q	Q(3)	IQ	VQ	VQ(3)	IVQ	UQ	IUQ
LITCHR	4	4	9	5	5	10	6	11
SIGGRP	(1)	(3)	( )	(1)	(3)	( )	(1)	( )

Rhythms of lights	Mo(K)	FFI	Q(6)+LFI	VQ(6)+LFI	Al.WR	Al.FI.WR	Al.FI(2W+1R)	Al.Oc(4)WR
LITCHR	12	13	25	26	28	19	19	17
SIGGRP	(K)	( ) (1)	(6) (1)	(6) (1)	( )	(1)	(2+1)	(4)

table 12.4

Some lights recently constructed may appear to the mariner as "fixed and flashing - FFL" by night, while the real world object actually comprises two separate lights vertically disposed, one fixed and the other flashing (F&FI). When it is known that two separate features actually exist, they must be encoded as separate objects, in this case two **LIGHTS** objects, one with attribute LITCHR = 1 (fixed) and the other with LITCHR = 2 (flashing), and not as one **LIGHTS** with LITCHR = 13 (fixed and flashing).

### 12.8.4 Elevations of lights (see S-4 – B-471.6)

If it is required to encode the elevation of a light on a fixed structure, it must be done using the attribute HEIGHT.

If it is required to encode the height above the water surface of a light on a floating structure, it must be done using the attribute INFORM on the **LIGHTS** object.

### 12.8.5 Times of exhibition and exhibition conditions (see S-4 – B-473)

#### 12.8.5.1 Night lights

If it is required to encode a night light, it must be done using a **LIGHTS** object, with attribute EXCLIT = 4 (night light).

**12.8.5.2 Unwatched lights (see S-4 – B-473.1)**

This information should not be encoded, but unwatched (unmanned) lights, with no standby or emergency arrangements, may be encoded using attribute STATUS = 17 (unwatched).

**12.8.5.3 Occasional lights (see S-4 – B-473.2)**

If it is required to encode an occasional light, it must be done using attribute STATUS = 2 (occasional). If it is required to encode a private light that is not regularly exhibited, it must be done using STATUS = 2,8 (occasional, private).

**12.8.5.4 Daytime lights (see S-4 – B-473.4)**

If it is required to encode a daytime light, it must be done using attribute EXCLIT = 1 (light shown without change of character).

If it is required to encode a light having characteristics shown by day different to those shown at night, it must be done by encoding two **LIGHTS** objects sharing the same point spatial object:

- one **LIGHTS** object with EXCLIT = 2 (daytime light); and
- one **LIGHTS** object with EXCLIT = 4 (night light).

**12.8.5.5 Fog lights (see S-4 – B-473.5)**

If it is required to encode a fog light, it must be done using a **LIGHTS** object, with attributes EXCLIT = 3 (fog light) and STATUS = 2 (occasional).

If it is required to encode a light having characteristics shown in fog that are different to those shown in conditions of normal visibility, it must be done by encoding two **LIGHTS** objects sharing the same point spatial object:

- one **LIGHTS** object with EXCLIT = 3 (fog light) and STATUS = 2 (occasional); and
- one **LIGHTS** object with EXCLIT = 2 (daytime light) or 4 (night light) and attribute INFORM = *Character of the light changes in fog.*

**12.8.6 Sector lights and lights not visible all round (see S-4 – B-475)****12.8.6.1 Sector lights (see S-4 – B-475.1)**

Each sector in which the light is visible from seaward must be encoded as one **LIGHTS** object.

There must be no object created to encode a sector where no light is exhibited.

Limits of sectors must be encoded using attributes SECTR1 and SECTR2.

Where it is required to encode an oscillating light sector (see S-4 – B-475.7), it should be done as follows:

For lights in the IALA A system that are alternating and oscillate increasingly from white to green (to starboard) and red (to port) with increasing deviation from the track defined by the directional light:

**LIGHTS:** LITCHR = 28 (alternating); COLOUR = 1,3 (white, red); SECTR1; SECTR2; SIGPER; SIGGRP; INFORM = *White phase decreases as bearing to light increases*

**LIGHTS:** LITCHR = 28 (alternating); COLOUR = 1,4 (white, green); SECTR1; SECTR2; SIGPER; SIGGRP; INFORM = *White phase increases as bearing to light increases*

For lights in the IALA B system that are alternating and oscillate increasingly from white to red (to starboard) and green (to port) with increasing deviation from the track defined by the directional light; transpose the colours red and green in the above encoding.

For lights in the IALA A system that are occulting green (to starboard) and red (to port) which oscillate with increasing period of eclipse to isophased or flashing with increasing deviation from the track defined by the directional light:

**LIGHTS:** LITCHR = 8 (occulting); COLOUR = 3 (red); SECTR1; SECTR2; SIGPER; SIGGRP; INFORM = *Light phase decreases as bearing to light increases*

**LIGHTS:** LITCHR= 8 (occulting); COLOUR = 4 (green); SECTR1; SECTR2; SIGPER; SIGGRP; INFORM = *Light phase increases as bearing to light increases*

For lights in the IALA B system that are occulting red (to starboard) and green (to port) which oscillate with increasing period of eclipse to isophased or flashing with increasing deviation from the track defined by the directional light; transpose the colours red and green in the above encoding.

Oscillating lights which are not IALA should be encoded similar to the above. For instance, where a light contains white sectors that are occulting and oscillate with increasing period of eclipse to isophased or flashing with increasing deviation from the track defined by the directional light:

For the sector to port of the track defined by the directional light:

**LIGHTS:** LITCHR = 8 (occulting); COLOUR = 1 (white); SECTR1; SECTR2; SIGPER; SIGGRP; INFORM = *Light phase decreases as bearing to light increases*

For the sector to starboard of the track defined by the directional light:

**LIGHTS:** LITCHR= 8 (occulting); COLOUR = 1 (white); SECTR1; SECTR2; SIGPER; SIGGRP; INFORM = *Light phase increases as bearing to light increases*

#### 12.8.6.2 Lights obscured by obstructions (see S-4 – B-475.3)

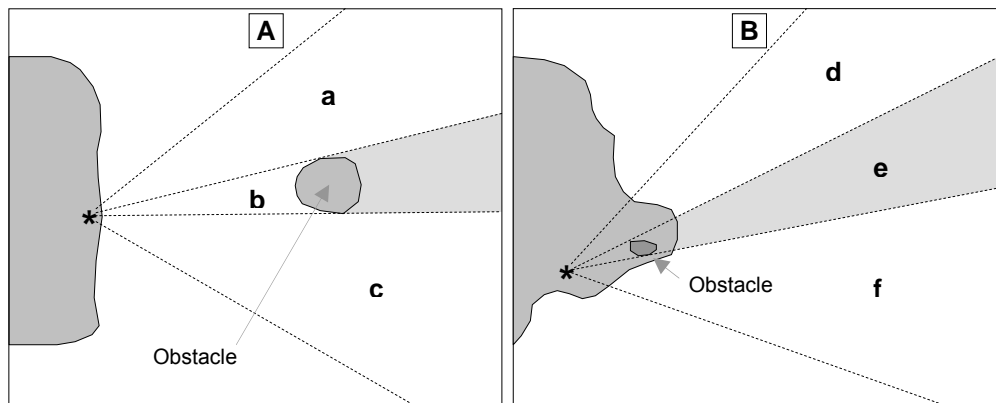

Figure 17 – Obscured light sectors

If an encoded light is obscured in a part of the navigable area of a sector (see Figure 17 - A) beyond an offshore obstruction, it must be encoded as several **LIGHTS** objects. The partially obscured sector of (b), seaward of the island, must be encoded as a **LIGHTS** object, with attributes LITVIS = 8 (partially obscured) and INFORM = *Sector obscured only beyond .....*. The sectors in which the light is visible from seaward ((a) and (c)) must be encoded as separate **LIGHTS** objects.

If there is no navigable water between the light and the obstruction (see Figure 17 - B), the masked sector (e) must be encoded as a **LIGHTS** object, with LITVIS = 3 (faint) or 7 (obscured).

#### 12.8.6.3 White fairway sectors (see S-4 – B-475.5)

The light sectors must be encoded as separate **LIGHTS** objects. The fairway defined by the succession of navigable areas in the white sectors may be encoded using the object class **FAIRWAY** (see clause 10.4).

#### 12.8.6.4 Leading lights (see S-4 – B-475.6)

If it is required to encode a leading light, it must be done using a **LIGHTS** object, with attribute:

CATLIT = 4,12 - front leading light  
4,13 - rear leading light  
4,14 - lower leading light

## 4,15 - upper leading light

## Remarks:

- The attribute ORIENT must not be used for leading lights, except for directional lights.
- Even if, on the source, the leading lights are merged into a single symbol, at least one **LIGHTS** object must be created for each light.
- The leading line must be encoded using the method described in clause 10.1.

**12.8.6.5 Directional lights (see S-4 – B-475.7)**

If it is required to encode a directional light, it must be done using a **LIGHTS** object, with attribute CATLIT = 1 (directional function) and, if the light is intensified in this sector, with attribute LITVIS = 4 (intensified).

The mandatory attribute ORIENT must only be encoded to indicate the orientation, measured from seaward, of the leading line of the directional light when the attributes SECTR1 and SECTR2 are not populated, and there is no **RECTRC** or **NAVLNE** object associated with the directional light. Where the **LIGHTS** has attributes SECTR1 and SECTR2 populated, and/or there is an associated **RECTRC** and/or **NAVLNE** encoded, ORIENT for the **LIGHTS** must be populated with and empty (null) value.

If it is required to encode the recommended track and/or navigation line associated with a directional light, it must be done using the method described in clause 10.1.

**12.8.6.6 Moiré effect lights (see S-4 – B-475.8)**

If it is required to encode a moiré effect light, it must be done using a **LIGHTS** object, with attribute CATLIT = 16 (moiré effect).

The mandatory attribute ORIENT must only be encoded to indicate the orientation, measured from seaward, of the leading line of the moiré effect light when the attributes SECTR1 and SECTR2 are not populated, and there is no **RECTRC** or **NAVLNE** object associated with the moiré effect light. Where the **LIGHTS** has attributes SECTR1 and SECTR2 populated, and/or there is an associated **RECTRC** and/or **NAVLNE**, ORIENT for the **LIGHTS** must be populated with and empty (null) value.

If it is required to encode the recommended track and/or navigation line associated with a moiré effect light, it must be done using the method described in clause 10.1.

**12.8.7 Various special types of lights**

Type	S-4	CATLIT	Remarks
Subsidiary light	B-471.8	10	
Aero light	B-476.1	5	
Air obstruction light	B-476.2	6	
Fog detector light	B-477	7	
Bearing light	B-478.1	18	
Flood light	B-478.2	8	Only to encode flood lights that are visible from seaward. The illuminated structure should be encoded using appropriate object classes, with attribute STATUS = 12 (illuminated).
Synchronised lights	B-478.3		STATUS = 15. Synchronised lights may be associated using the collection object <b>C_ASSO</b> .
Strip light	B-478.5	9	See below for strip lights performing the function of an aid to navigation.
Spot light		11	Only to encode spot lights that are visible from seaward. The illuminated feature should be encoded using appropriate object classes, with attribute STATUS = 12 (illuminated).
Emergency light		17	Must be encoded as a separate object to the main <b>LIGHTS</b> object.

Type	S-4	CATLIT	Remarks
Horizontally disposed lights	B-471.8	19	The number of lights must be encoded using attribute MLTYLT.
Vertically disposed lights	B-471.8	20	The number of lights must be encoded using attribute MLTYLT.

table 12.5

For ECDIS display reasons, where an encoded strip light serves the purpose of an aid to navigation, the attribute CATLIT = 9 (strip light) for the **LIGHTS** object should not be populated. To identify that the aid to navigation is a strip light, the attribute INFORM should be populated with *Strip light* or equivalent for the **LIGHTS**.

### 12.8.8 Light structures

If a light that is on a fixed structure is located in a water area and the structure that supports it is unknown, a **PILPNT** object of type point or a **BCNSPP** object must also be encoded at the same position as the light. This will ensure that a symbol will be shown on ECDIS systems when the **LIGHTS** objects are not displayed during daytime navigation.

## 12.9 Radio stations (see S-4 – B-480 to B-484)

Transmissions from radio stations may provide mariners with a line of position. Most radio position fixing systems require Radio Direction Finding (RDF) equipment to determine the bearing of the transmitting device; such equipment is generally no longer fitted on vessels. The exception is “emergency use only” VHF-based direction finding services (which do not use RDF equipment). Consequently, the following radio position-fixing stations are now obsolete and there is no longer any value in encoding them on ENCs:

- Circular (non-directional) (RC), directional (RD) and rotating pattern (RW) marine radiobeacons;
- Consol beacons (Consol);
- Aeronautical radiobeacons (Aero RC);
- Radio direction-finding stations (except VHF-based emergency stations) (RG);
- Coast Radio Stations providing ‘QTG’ service (R).

If it is required to encode a radio station, it must be done using the object class **RDOSTA**.

Geo object: Radio station (**RDOSTA**) (P)  
 Attributes: CALSGN CATROS COMCHA DATEND DATSTA ESTRNG NOBJNM  
 OBJNAM ORIENT PEREND PERSTA SIGFRQ STATUS INFORM  
 NINFOM

Remarks:

- The **RDOSTA** must only be used to encode the technical equipment itself, independent of the building or structure in which it is installed. If it is required to encode the building or structure (e.g. mast, tower, radar dome), it must be done using an appropriate object class (e.g. **BUISGL**, **LNDMRK**).
- Further information (e.g. transmission characteristic) may be encoded using attribute INFORM or TXTDSC.
- Each VHF-channel should be indicated, using the attribute COMCHA, in square brackets by 2 digits and up to 2 characters (A-Z); e.g. VHF channel 7 = [07], VHF channel 16 = [16]. The indication of several VHF-channels is possible, with each value being separated by a semicolon; e.g. VHF channels 7 and 16 = [07];[16].
- If it is required to encode a DGPS station, it must be done using **RDOSTA**, with attribute CATROS = 10 (Differential GPS).
- Where required, the attribute SIGFRQ must be quoted in Hertz, e.g. a signal frequency of 950 MHz must be encoded as 950000000.

**12.9.1 Marine and aero-marine radiobeacons (see S-4 – B-481)**

It is no longer useful to encode marine and aero-marine radiobeacons for ENCs.

If it is required to encode a marine and aero-marine radiobeacon, it must be done using a **RDOSTA** object, with attributes:

- CATROS - 1 - circular (omni-directional) marine or aero-marine radiobeacon  
 2 - directional radiobeacon  
 3 - rotating-pattern radiobeacon  
 4 - Consol beacon
- ORIENT - value of the bearing from seaward. Applies only for CATROS = 2.

Remarks:

- If it is required to encode the bearing line and the recommended track for a directional radiobeacon, it must be done as described in clause 10.1. Where the bearing line coincides with a leading line defined by lights or other visual features making up a range system, navigation lines and recommended tracks must not be duplicated. The objects making up the range system must be aggregated using the collection object **C\_AGGR** (see clause 10.1.2).

**12.9.2 Aeronautical radiobeacons (see S-4 – B-482)**

It is no longer useful to encode aeronautical radiobeacons for ENCs.

If it is required to encode an aeronautical radiobeacon, it must be done using a **RDOSTA** object, with attribute CATROS = 7 (aeronautical radiobeacon). The identification signal may be encoded using the attribute CALSGN.

**12.9.3 Radio direction-finding stations (see S-4 – B-483)**

If it is required to encode a radio direction-finding station, it must be done using a **RDOSTA** object, with attribute CATROS = 5 (radio direction-finding station). The identification signal may be encoded using the attribute CALSGN.

Remarks:

- Direction-finding is now only provided as an emergency service by VHF.

**12.9.4 Coast radio stations providing QTG service (see S-4 – B-484)**

It is no longer useful to encode coast radio stations providing QTG services for ENCs.

If it is required to encode a coast radio station which provides a QTG service, it must be done using a **RDOSTA** object, with attribute CATROS = 6 (coast radio station providing QTG service).

**12.10 Radar beacons (see S-4 – B-486)**

If it is required to encode a radar beacon, it must be done using the object class **RTPBCN**.

Geo object: Radar transponder beacon (**RTPBCN**) (P)  
 Attributes: CATRTB DATEND DATSTA NOBJNM OBJNAM PEREND PERSTA  
 RADWAL SECTR1 SECTR2  
 SIGGRP - Morse identification letter(s).  
 SIGSEQ STATUS VALMXR INFORM NINFOM

Remarks:

- The **RTPBCN** must only be used to encode the technical equipment itself, independent of the building or structure in which it is installed. If it is required to encode the building or structure (e.g. mast, tower, radar dome), it must be done using an appropriate object class (e.g. **BUISGL**, **LNDMRK**).
- If it is required to encode the bearing line and the recommended track for leading racons, it must be done as described in clause 10.1. Where the bearing line coincides with a leading line defined by lights or other visual features making up a range system, navigation lines and recommended



tracks must not be duplicated. The objects making up the range system must be aggregated using the collection object **C\_AGGR** (see clause 10.1.2).

- The sweep period may be encoded using the attribute **INFORM**.

### 12.11 Radar surveillance systems (see S-4 – B-487)

If it is required to encode a radar surveillance system, it must be done using the object classes **RADRNG**, **RADLNE** and **RADSTA**.

#### 12.11.1 Radar ranges (see S-4 – B-487.1)

If it is required to encode a radar range, it must be done using the object class **RADRNG**.

Geo object: Radar range (**RADRNG**) (A)  
 Attributes: COMCHA DATEND DATSTA NOBJNM OBJNAM STATUS INFORM  
 NINFOM

Remarks:

- **RADRNG** objects must be of type area.
- Each VHF-channel should be indicated, using the attribute **COMCHA**, in square brackets by 2 digits and up to 2 characters (A-Z); e.g. VHF channel 7 = [07], VHF channel 16 = [16]. The indication of several VHF-channels is possible, with each value being separated by a semicolon; e.g. VHF channels 7 and 16 = [07];[16].

#### 12.11.2 Radar reference lines (see S-4 – B-487.2)

If it is required to encode a radar reference line, it must be done using the object class **RADLNE**.

Geo object: Radar line (**RADLNE**) (L)  
 Attributes: NOBJNM OBJNAM  
 ORIENT - value of the bearing from seaward.  
 STATUS INFORM NINFOM

#### 12.11.3 Radar station (see S-4 – B-487.3)

If it is required to encode a radar station, it must be done using the object class **RADSTA**.

Geo object: Radar station (**RADSTA**) (P)  
 Attributes: CATRAS COMCHA DATEND DATSTA  
 HEIGHT - height of the emitting part of the radar.  
 NOBJNM OBJNAM PEREND PERSTA STATUS VERACC VALMXR  
 VERDAT INFORM NINFOM

Remarks:

- The **RADSTA** must only be used to encode the technical equipment itself, independent of the building or structure in which it is installed. If it is required to encode the building or structure (e.g. mast, tower, radar dome) it must be done using an appropriate object class (e.g. **BUISGL**, **LNDMRK**).
- Each VHF-channel should be indicated, using the attribute **COMCHA**, in square brackets by 2 digits and up to 2 characters (A-Z); e.g. VHF channel 7 = [07], VHF channel 16 = [16]. The indication of several VHF-channels is possible, with each value being separated by a semicolon; e.g. VHF channels 7 and 16 = [07];[16].

### 12.12 Radar conspicuous objects (see S-4 – B-485.2)

The attribute **CONRAD** (conspicuous, radar) is used to encode whether or not an object is radar conspicuous.

Remarks:

- If it is required to encode an object which has no radar reflector, but is radar conspicuous, it must be indicated using attribute **CONRAD** = 1 (radar conspicuous) on the object.

- If it is required to encode an area or point object which is radar conspicuous because it is fitted with a radar reflector, it must be indicated using CONRAD = 3 (radar conspicuous (has radar reflector)) on the object.
- If it is required to encode radar reflectors on line objects (e.g. overhead cables), this must be done using the object class **RADRFL**.

Geo object: Radar reflector (**RADRFL**) (P)  
 Attributes: HEIGHT STATUS VERACC VERDAT INFORM NINFOM

### 12.13 Radio reporting (calling-in) points (see S-4 – B-488)

If it is required to encode a radio reporting point or line, it must be done using the object class **RDOCAL**.

Geo object: Radio calling-in point (**RDOCAL**) (P,L)  
 Attributes: COMCHA DATEND DATSTA NOBJNM  
 OBJNAM - e.g. alphanumeric designator.  
 ORIENT - orientation of the traffic flow at that point.  
 PEREND PERSTA STATUS TRAFIC  
 INFORM - notes; for example, if the requirement to report by radio relates to certain classes of vessels only. The attribute TXTDSC may be used instead of INFORM, or for longer explanations or notes.  
 NINFOM

Remarks:

- Each **RDOCAL** object must only carry one orientation. If it is required to encode the reciprocal orientation, to indicate that a bearing and its opposite apply to a **RDOCAL** object, it must be done using attribute TRAFIC = 4 (two-way). If the same position is used for another orientation (not opposite) of traffic flow, an additional **RDOCAL** object must be created.
- **RDOCAL** objects of type line should be digitised such that the traffic direction that is required to report is to the right.
- If it is required to encode the area of a Vessel Traffic Service (VTS) containing radio reporting points or requiring periodic position reporting, this should be done using the object class **ADMARE** (see clause 11.2.1). The **ADMARE** and any associated **RDOCAL** points may be aggregated using the collection object **C\_AGGR** (see clause 15).
- Each VHF-channel should be indicated, using the attribute COMCHA, in square brackets by 2 digits and up to 2 characters (A-Z); e.g. VHF channel 7 = [07], VHF channel 16 = [16]. The indication of several VHF-channels is possible, with each value being separated by a semicolon; e.g. VHF channels 7 and 16 = [07];[16].

## 12.14 Automatic Identification Systems (AIS)

### 12.14.1 AIS equipped aids to navigation (see S-4 – B-489)

AIS signals used as an aid to navigation may:

- actually be transmitted from a physical aid to navigation (physical AIS aid to navigation);
- appear to be transmitted from a physical aid to navigation but is actually transmitted from an AIS base station (synthetic AIS aid to navigation); or
- be transmitted from an AIS base station to represent an aid to navigation where a physical aid to navigation does not exist (virtual AIS aid to navigation).

It is not required to encode AIS information on ENCs, as ENCs are intended to be used in conjunction with ECDIS as part of an Integrated Bridge System, in which AIS targets are displayed when in range. If, however, Producing Authorities wish to indicate the presence of a physical or synthetic AIS aid to navigation to aid in the route planning process or for use in ECS or other navigation systems, this may be done using the attribute INFORM on the physical aid to navigation structure (master) object (see clause 12.1.1), e.g. *Automatic Identification System (AIS) aid to navigation*.

**12.14.1.1 Virtual AIS aids to navigation (see S-4 – B-489.2)**

Given that AIS technology is increasingly being used for aids to navigation purposes, it is considered that there is a requirement to implement an interim solution to enable the encoding of Virtual AIS aids to navigation in ENC. Accordingly, the IHO Hydrographic Standards and Services Committee (HSSC) has approved the use of the **NEWOBJ** object class for this purpose (see clause 16).

If it is required to encode a Virtual AIS aid to navigation, it must be done using the object class **NEWOBJ**.

Geo object: New object (**NEWOBJ**) (P)  
 Attributes: CLSNAM CLSDEF DATEND DATSTA STATUS INFORM  
                   NINFOM NOBJNM OBJNAM TXTDSC NTXTDS SCAMIN  
                   SORIND SORDAT SYMINS

The following table shows the combinations for the mandatory attributes CLSDEF, CLSNAM and SYMINS that must be populated, according to the purpose of the Virtual AIS aid to navigation and the corresponding portrayal for each encoding:











<u>Purpose of Virtual Aid</u>	<u>CLSDEF</u>	<u>CLSNAM</u>	<u>SYMINS</u>	<u>PORTRAYAL</u>
North Cardinal	A Virtual object which indicates navigable water lies northwards	Virtual AtoN, North Cardinal	SY(BRTHNO01);SY(BCNCAR01); TX('V-AIS',3,2,2,'15110',2,0,CHMGD,11)	 V-AIS
East Cardinal	A Virtual object which indicates navigable water lies eastwards	Virtual AtoN, East Cardinal	SY(BRTHNO01);SY(BCNCAR02); TX('V-AIS',3,2,2,'15110',2,0,CHMGD,11)	 V-AIS
South Cardinal	A Virtual object which indicates navigable water lies southwards	Virtual AtoN, South Cardinal	SY(BRTHNO01);SY(BCNCAR03); TX('V-AIS',3,2,2,'15110',2,0,CHMGD,11)	 V-AIS
West Cardinal	A Virtual object which indicates navigable water lies westwards	Virtual AtoN, West Cardinal	SY(BRTHNO01);SY(BCNCAR04); TX('V-AIS',3,2,2,'15110',2,0,CHMGD,11)	 V-AIS
Port lateral (IALA A)	A Virtual object marking the port side of a channel	Virtual AtoN, Port Lateral	SY(BRTHNO01);SY(BOYLAT24); TX('V-AIS',3,2,2,'15110',2,0,CHMGD,11)	 V-AIS
Starboard Lateral (IALA A)	A Virtual object marking the starboard side of a channel	Virtual AtoN, Starboard Lateral	SY(BRTHNO01);SY(BOYLAT13); TX('V-AIS',3,2,2,'15110',2,0,CHMGD,11)	 V-AIS
Port lateral (IALA B)	A Virtual object marking the port side of a channel	Virtual AtoN, Port Lateral	SY(BRTHNO01);SY(BOYLAT23); TX('V-AIS',3,2,2,'15110',2,0,CHMGD,11)	 V-AIS
Starboard Lateral (IALA B)	A Virtual object marking the starboard side of a channel	Virtual AtoN, Starboard Lateral	SY(BRTHNO01);SY(BOYLAT14); TX('V-AIS',3,2,2,'15110',2,0,CHMGD,11)	 V-AIS
Isolated Danger	A Virtual object marking an isolated danger	Virtual AtoN, Isolated Danger	SY(BRTHNO01);SY(BCNISD21); TX('V-AIS',3,2,2,'15110',2,0,CHMGD,11)	 V-AIS
Safe Water	A Virtual object marking safe water	Virtual AtoN, Safe Water	SY(BRTHNO01);SY(BOYSAW12); TX('V-AIS',3,2,2,'15110',2,0,CHMGD,11)	 V-AIS
Special Purpose	A Virtual object used to mark an area or feature referred to in nautical documents	Virtual AtoN, Special Purpose	SY(BRTHNO01);SY(BOYSPP11); TX('V-AIS',3,2,2,'15110',2,0,CHMGD,11)	 V-AIS
Emergency Wreck Marking	A Virtual object marking a wreck	Virtual AtoN, Wreck Marking	SY(BRTHNO01);SY(BOYSPP11); TX('V-AIS',3,2,2,'15110',2,0,CHMGD,11)	 V-AIS

table 12.6

For reasons of backward compatibility the mandatory attribute INFORM must contain the values of CLSNAM and CLSDEF for the object; e.g. *Virtual AIS AtoN, North Cardinal*; *A virtual object which indicates navigable water lies northwards* for a Virtual AIS aid to navigation performing the function of a north cardinal mark.

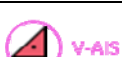
Where known the attribute OBJNAM should be populated with the MMSI number of the Virtual AIS aid to navigation, in addition to its individual name, e.g. *Nab Rock, MMSI 995031014*.

Virtual AIS aids to navigation should only be encoded where it is known that the Virtual aid is intended to be permanent, or deployed for a specified fixed period. Where it is known that a Virtual AIS aid to navigation is moved or withdrawn on a regular basis and/or at short notice, such that implementing these changes through the application of ENC Updates is impractical, the Virtual aid should not be encoded.

A new validation check for this implementation of **NEWOBJ** will be included in the next version of S-58. Until validation tools have implemented the new check, encoders must consider appropriate validation measures when using the New Object as the correct encoding of the SYMINS attribute is critical to ensuring a correct display in ECDIS.

Remarks:

- Note that ENC production systems may include the full list of allowable attributes for the **NEWOBJ** object class as specified in clause 16. For encoding of **NEWOBJ** for Virtual AIS aids to navigation, only those attributes defined above are allowable. Any other attributes listed in the production system for **NEWOBJ** must not be populated.

## 13 Marine services and signal stations

### 13.1 Pilot stations (see S-4 – B-491)

#### 13.1.1 Pilot stations ashore (see S-4 – B-491.3 and B-491.4)

If it is required to encode a pilot station, it must be done using a **BUISGL** or **LNDMRK** object, with attribute FUNCTN = 11 (pilot office) or 12 (pilot lookout).

#### 13.1.2 Pilot boarding places (see S-4 – B-491.1 and B-491.2)

If it is required to encode a pilot boarding place, it must be done using the object class **PILBOP**.

Geo object: Pilot boarding place (**PILBOP**) (P,A)  
 Attributes: CATPIL COMCHA DATEND DATSTA NOBJNM NPLDST OBJNAM  
 PEREND PERSTA PILDST STATUS INFORM NINFOM

Remarks:

- Each VHF-channel should be indicated, using the attribute COMCHA, in square brackets by 2 digits and up to 2 characters (A-Z); e.g. VHF channel 7 = [07], VHF channel 16 = [16]. The indication of several VHF-channels is possible, with each value being separated by a semicolon; e.g. VHF channels 7 and 16 = [07];[16].
- Areas within which pilotage services apply, often called pilotage districts, should be encoded using an **ADMARE** object (see clause 11.2.1) with the name encoded using the attribute OBJNAM. Where the limit of the pilotage district is coincident with administrative harbour or port limits it is not required to encode an **ADMARE** object, as the existence of pilotage services may be implied from the corresponding **HRBARE** object (see clause 9.1.1).

### 13.2 Coastguard stations (see S-4 – B-492)

If it is required to encode a coastguard station, it must be done using the object class **CGUSTA**.

Geo object: Coastguard station (**CGUSTA**) (P)  
 Attributes: DATEND DATSTA NOBJNM OBJNAM PEREND PERSTA STATUS  
 INFORM NINFOM

Remarks:

- The **CGUSTA** must only be used to describe the function of the coastguard station, independent of the building or structure itself. If it is required to encode the building or structure in which the coastguard station operates, it must be done using an appropriate object class (e.g. **BUISGL**, **LNDMRK**).
- Maritime Rescue and Coordination Centres (MRCC) are part of a constantly manned communications watch system. If it is required to encode a MRCC, it should be done using **CGUSTA**, with attribute INFORM = *Maritime Rescue and Coordination Centre*. The name of the station may be populated using the attribute OBJNAM, e.g. *MRCC Swansea*.

### 13.3 Rescue stations (see S-4 – B-493)

If it is required to encode a rescue station, it must be done using the object class **RSCSTA**.

Geo object: Rescue station (**RSCSTA**) (P)  
 Attributes: CATRSC DATEND DATSTA NOBJNM OBJNAM PEREND PERSTA  
 STATUS INFORM NINFOM

Remarks

- The **RSCSTA** must only be used to describe the function of the rescue station, independent of the building or structure itself. If it is required to encode the building or structure housing the service, it must be done using an appropriate object class (e.g. **BUISGL**, **LNDMRK**).

- If it is required to encode a refuge beacon, it must be done using a **BCNSPP** object, with attribute CATSPM = 44 (refuge beacon), not by using **RSCSTA**.

### 13.4 Signal stations (see S-4 – B-494 to B-497)

If it is required to encode a signal station, it must be done using traffic signal stations or warning signal stations.

Geo object: Signal station, traffic (**SISTAT**) (P)  
 Attributes: CATSIT COMCHA DATEND DATSTA NOBJNM OBJNAM PEREND  
 PERSTA STATUS INFORM NINFOM

Remarks:

- If it is required to encode a bridge light marking the centre of a navigable span, it must be done using the object class **LIGHTS**.
- The **SISTAT** must only be used to describe the function of the signal station, independent of the building or structure itself. If it is required to encode the building or structure housing the service, it must be done using an appropriate object class (e.g. **BUISGL**, **LNDMRK**).
- Each VHF-channel should be indicated, using the attribute COMCHA, in square brackets by 2 digits and up to 2 characters (A-Z); e.g. VHF channel 7 = [07], VHF channel 16 = [16]. The indication of several VHF-channels is possible, with each value being separated by a semicolon; e.g. VHF channels 7 and 16 = [07];[16].

Geo object: Signal station, warning (**SISTAW**) (P)  
 Attributes: CATSIW COMCHA DATEND DATSTA NOBJNM OBJNAM PEREND  
 PERSTA STATUS INFORM NINFOM

Remarks:

- The **SISTAW** must only be used to describe the function of the signal station, independent of the building or structure itself. If it is required to encode the building or structure housing the service, it must be done using an appropriate object class (e.g. **BUISGL**, **LNDMRK**).

## 14 Geographic names

If it is required to encode an international or national geographic name, it must be done using attributes OBJNAM and NOBJNM as described in the ENC Product Specification (S-57 Appendix B.1), clause 3.11. The use of the cartographic object **\$TEXTS** is prohibited.

When possible, existing objects (e.g. **BUAARE**, **RIVERS**, navigational marks) should be used to carry this information.

If it is required to encode a geographic name for which there is no existing object, a specific **ADMARE**, **SEAARE** or **LNDRGN** object must be created (see clauses 4.7.1 and 8). In order to minimise the data volume, these objects should, where possible, use the geometry of existing objects, e.g. a **SEAARE** object may use the geometry of a **DEPARE** object.

National geographic names can be left in their original national language in the international attribute OBJNAM (but only if the national language can be expressed using lexical level 0 or 1), or transliterated or transcribed and used in the international attribute OBJNAM, in which case the national name should be populated in the national attribute NOBJNM.

Geographic names should be encoded using OBJNAM based on the following criteria and at the Producing Authority's discretion:

1. Named points or capes that do not contain navigational aids should be encoded as **LNDRGN** objects (of type area or point), with the geographic name encoded using OBJNAM.
2. Named points or capes that contain one navigational aid should be encoded using OBJNAM on the master object associated with the navigational aid. If more than one navigational aid exists on the point or cape, a **LNDRGN** object (of type area or point) should be encoded, with the geographic name encoded using OBJNAM .
3. A group of hydrographic objects (e.g. **SBDARE**, **UWTROC**, **OBSTRN**), associated with a particular geographic name, should have the name encoded using OBJNAM on a **SEAARE** object (of type area or point). The name should not be encoded on the individual hydrographic objects.
4. A major island name close to primary shipping corridors should be encoded using OBJNAM on the **LNDRGN** object delimiting the island. A group of islands associated with a geographic name should have the name encoded using OBJNAM on a **LNDRGN** object (of type area or point).
5. Named features listed in HOs' Sailing Directions that may assist in navigation should be encoded using OBJNAM on the relevant object (e.g. **LNDRGN**, **UWTROC**, **SBDARE**, **SEAARE**, **OBSTRN**).
6. If it is required to encode an administrative area of international, national, provincial or municipal jurisdiction that may have legal inference, it must be done using an **ADMARE** object, with the name encoded using OBJNAM.
7. If it is required to encode a major city along the coast, it must be done using **BUAARE** or **ADMARE** objects (see clause 4.8.14), with the name encoded using OBJNAM.
8. If it is required to encode the name of a navigable river, lake or canal, it must be done using a **SEAARE** object, with the name encoded using OBJNAM.

In all instances, if the exact extent of the feature to be named is known, an area object must be created. If the exact extent is not known, an existing or specifically encoded point object should be used to encode the geographic name.

## 15 Collection objects

If it is required to identify an aggregation or association between two or more objects, it must be done using the object classes **C\_AGGR** or **C\_ASSO**.

Collection object: Aggregation (**C\_AGGR**) (N)  
Attributes: NOBJNM OBJNAM INFORM NINFOM

**C\_AGGR** objects should be used to encode the link between objects that are functionally related and which together form a higher level entity. For example, a navigation line, a recommended track and the defining navigational aids should be linked using a **C\_AGGR** object to form a range system.

Collection object: Association (**C\_ASSO**) (N)  
Attributes: NOBJNM OBJNAM INFORM NINFOM

**C\_ASSO** objects should be used to encode the association between two or more objects. The association does not create any higher level entity. For example, a wreck should be associated with the buoy that marks it.

The following table shows the most common examples of the application of collection objects. Other applications for collection objects are possible.

Relationships	FFPT field	Collection object	Comment
Mooring trots	peer *	<b>C_AGGR</b>	see 9.2.5
Measured distances	peer *	<b>C_AGGR</b>	see 10.1.3
Traffic Separation Schemes systems	peer *	<b>C_AGGR</b>	see 10.2.3
Navigation lines and tracks	peer *	<b>C_AGGR</b>	see 10.1.2
Navigation lines, tracks and dangers	peer *	<b>C_ASSO</b>	see 10.1.2 **
Synchronised lights	peer *	<b>C_ASSO</b>	see 12.8.7
Airfield, airport, (runway, control etc.)	peer *	<b>C_ASSO</b>	see 4.8.12
Tide, tidal stream (non-harmonic prediction – time series or harmonic prediction)	peer *	<b>C_ASSO</b>	see 3.2.3, 3.3.3 and 3.3.4
Anchorage	peer *	<b>C_ASSO</b>	see 9.2.6
Fairway	peer *	<b>C_ASSO/C_AGGR</b>	see 10.4
Radar beacon	peer *	<b>C_AGGR</b>	see 12.10

table 15.1

\* Relationships defined using collection objects are assumed to be peer to peer. The RIND subfield of the collection feature record must be “peer” (see ENC Product Specification, clause 3.9).

\*\* Such a **C\_ASSO** object must not be used to link the individual elements of the navigation lines and tracks, but should be used to show the relationship between the navigation lines and tracks and the associated dangers.

Relationships may be hierarchical.

If a collection object extends beyond a cell boundary (i.e. the objects that makes up the collection are spread over multiple cells), the collection object should be repeated in each cell that contains one or more component objects. However, only the objects that exist in the cell that contains the instance of the collection object can be referenced by that collection object. If this technique is used, each instance of the original collection object must have the same feature identifier (LNAM). It is up to the application (e.g. the ECDIS) that uses the cells to rebuild the complete collection object based on the unique feature identifier.



It is highly recommended that no use be made of pointers that reference objects outside the cell in which the pointer is encoded. Use of such pointers cannot be prohibited, as no such rule exists in the ENC Product Specification.

Remarks:

- Guidance on how objects **C\_AGGR** and **C\_ASSO** are to be utilised (displayed and interrogated) in the ECDIS have not been included in IMO, IEC and IHO documents related to the performance and display aspects of ECDIS. As a result, most ECDIS do not have the capability to display or interrogate these objects where they are encoded. Therefore encoders should not encode navigationally relevant information using the allowable attributes for **C\_AGGR** or **C\_ASSO** (e.g. OBJNAM and TXTDSC). Where it is required to indicate the name of an aggregated feature (such as a traffic separation scheme), this should be done using a **SEAARE**, **LNDRGN** or **ADMARE** object as described in clause 14, or by populating OBJNAM for the most representative object in the collection. Where it is required to populate textual information for an aggregated feature, this should be done using a **M\_NPUB** object (see clauses 2.5), with attributes INFORM and/or TXTDSC (see clause 2.3), or if the information is considered essential for safe navigation, using a **CTNARE** object (see clause 6.6).

## 16 New Object

If it is required to encode a new object specified by the IMO and that affects safety of navigation which cannot adequately be encoded by any existing S-57 E3.1 object class, it must be done using the feature object class **NEWOBJ**. The “New Object” feature object class must only be used in conjunction with an ENC Encoding Bulletin issued by the IHO. The Bulletin will provide the specifics on how to use the object class for a particular application. The “New Object” feature object class must not be used under any other circumstances.

Geo object: New Object (**NEWOBJ**) (P,L,A)  
 Attributes: CLSDEF CLSNAM COLOUR COLPAT CONDTN CONRAD CONVIS  
 DATEND DATSTA NATION NOBJNM OBJNAM PEREND PERSTA  
 RESTRN STATUS WATLEV INFORM NINFOM NTXTDS SYMINS  
TXTDSC

### Remarks:

- When approved for use, the attribute CLSDEF must be defined in the data itself and is the detailed definition of all objects comprising the new object class. It is comparable to the definition section of an existing object class in the Object Catalogue. All objects that belong to the same object class (CLSNAM) must use an identical definition and this definition must also be used for the proposal to the S-100 Registry.
- When approved for use, the attribute CLSNAM must also be defined in the data itself and contains the descriptive name of the object class. For an object class that is defined in an existing Object Catalogue, this is the name of the object class e.g. “Depth Area”. CLSNAM must not be used for the common name of the real world object. Common names must be encoded by use of OBJNAM and or NOBJNM. CLSNAM is a generic name to categorize all objects of one class and therefore all objects that belong to the same object class must have an identical CLSNAM. The value used for CLSNAM must also be used for the new feature object class when it is proposed to the S-100 Registry.
- At least one of INFORM or TXTDSC is mandatory, not both. INFORM is used to describe the feature for ECDIS systems that are not yet S-57 Edition 3.1 Supplement No. 2 compatible, as was done for the new attribute values for S-57 Edition 3.1. For consistency, when one or both of these attributes is used, the text must commence with the approved object class name (CLSNAM) of the feature, such as “Archipelagic Sea Lane”.
- This object class has default symbology in the S-52 Presentation Library Edition 3.4 (and any later editions), however for features that are considered to affect safety of navigation, an existing symbol must be approved by IHO TSMAD and DIPWG from the S-52 Symbol Library, in order to portray the feature more accurately on an ECDIS. If the attribute SYMINS is populated with a valid symbol instruction, this will override the default symbology. Note that there are separate symbol names for point, simple and complex lines, area, and text symbology.
- A corresponding ENC Encoding Bulletin will provide the specific attribute values (strings) and instructions on how to use the object class for a particular application. This object class must not be used without an ENC Encoding Bulletin issued by the IHO on the authority of TSMAD/DIPWG.
- In addition to the issue of the ENC Encoding Bulletin, a new feature object class proposal (and new attributes if necessary) must also be made to the S-100 Registry. For future editions of the Product Specification, the new object class will be considered for inclusion in the ENC Feature Catalogue.

## 17 Masking

To improve the look and feel of the display of ENCs in ECDIS for the mariner certain objects, or certain edges of objects, should be masked (see S-57 Appendix B.1 – ENC Product Specification clause 3.8). For example, the boundaries of anchorage area symbols overwrite coincident pontoon symbols:

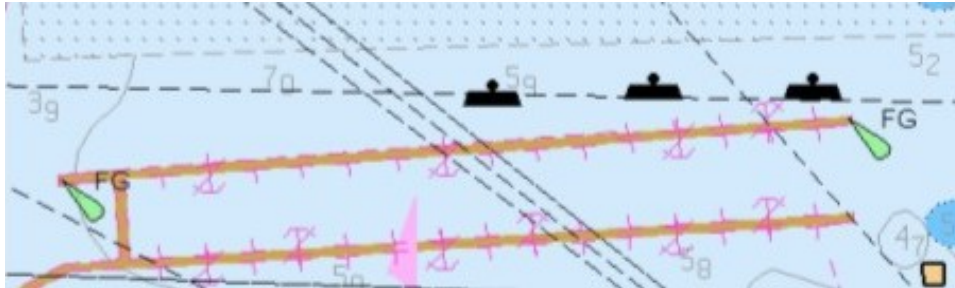

Figure 18 – Overwriting symbols - example

In order to best determine the appropriate level of masking required for an ENC cell, it is recommended that the ENC be viewed in an ECDIS.

The following scenarios where masking is recommended should be considered by compilers;

### 1. Area objects crossing ENC cell boundaries:

When a single area object crosses the boundaries of adjoining ENC cells, mask the edge where it shares the geometry of the boundary in each ENC:

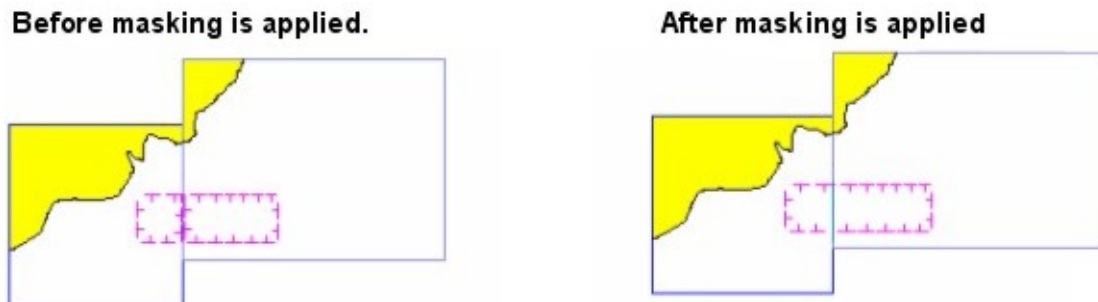

Figure 19 – Area object crossing ENC cell boundaries

This allows the objects to be displayed as a single area object rather than being divided at the cell boundary and having the representation of two separate objects. Note that some ENC production software will automatically truncate (mask) features at the cell boundary.

NOTE: Occasionally an edge of the boundary of an area actually coincides with the ENC cell boundary. Where this occurs and the ENC production system applies automatic truncation (masking) of this edge, the compiler must “unmask” that edge so as to avoid the appearance of the area to be “open ended”.

Where area objects extend beyond the entire limit of data coverage for the ENC cell (**M\_COVR** with attribute **CATCOV = 1** (coverage available)), all edges of these area objects should be masked.

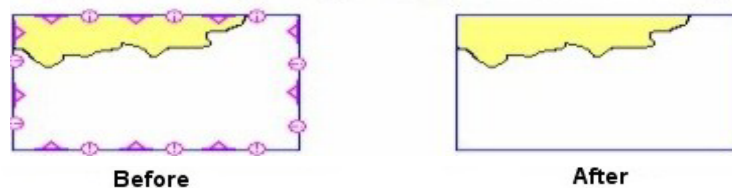

Figure 20 – Area objects extending beyond the entire limit of data coverage

Where a cell contains an area of no data coverage (**M\_COVR** with CATCOV = 2 (no coverage available)), and the ENC production software applies automatic truncation (masking) of features extending beyond the limit of data coverage of the ENC, edges of area features extending beyond the internal limit of the area of no data coverage may need to be masked manually.

The following table lists those area objects that should have edges masked where the boundary of the area crosses or extends beyond the ENC cell limit or the area of data coverage of the ENC cell.

Object-class	Comment
ACHARE	
CBLARE	
CTNARE	Also edges that are shared with Traffic Separation Scheme (TSS) as part of C_AGGR
CTSARE	
DMPGRD	
DRGARE	
EXEZNE	
FSHGRD	
FSHZNE	
HRBARE	
ICEARE	
ICNARE	
M_SREL	
M_QUAL	
MIPARE	
OSPARE	
PILBOP	When the whole cell falls within a pilotage area.
PIPARE	
PRCARE	Not applied if it is within a TSS.
RESARE	
SPLARE	
SNDWAV	
SUBTLN	
TESARE	
VEGATN	
WATTUR	

table 17.1

## 2. Area objects having edges coincident with the coastline:

Areas having edges coincident with the coastline may be in the water or on land. Where the coastal edge of these areas has no significance to the mariner, these edges should be masked so as to avoid screen clutter and the possibility of overwriting other important coastal information.

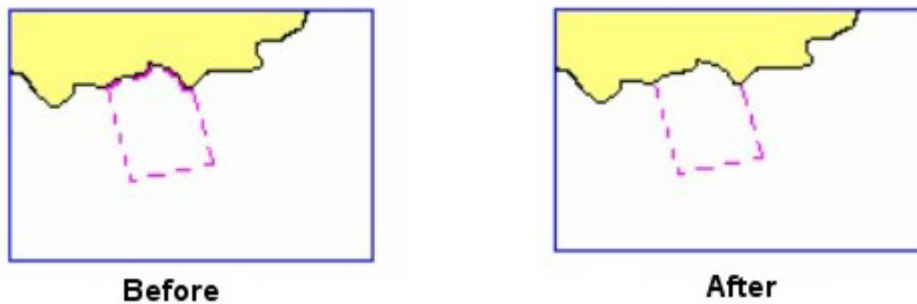

**Figure 21 – Area object with edges coincident with the coastline**

This process should also be considered for areas that have edges coincident with other coastal features, e.g. the boundaries of anchorage area symbols overwriting coincident pontoon symbols (see example at Figure 18 above).

Similarly, internal edges of these areas should be masked where they are coincident with the coastline of islands located within the area.

### 3. Area objects having ECDIS symbol pattern fill:

Areas symbolised in ECDIS with a patterned fill, and for which the outer edge of the area has no significance (or is subject to change or intermittent), e.g. **VEGATN** (see Figure 22 below) or **WATTUR** objects, may have the boundary of the area masked to reduce screen clutter.

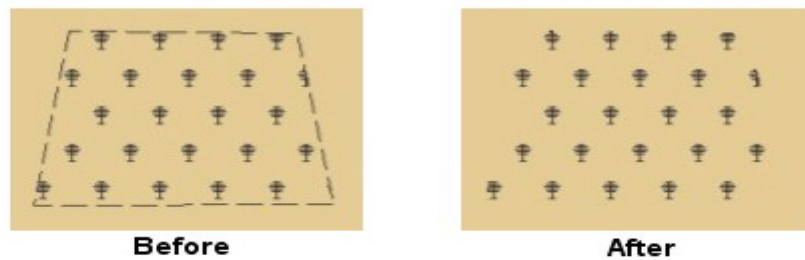
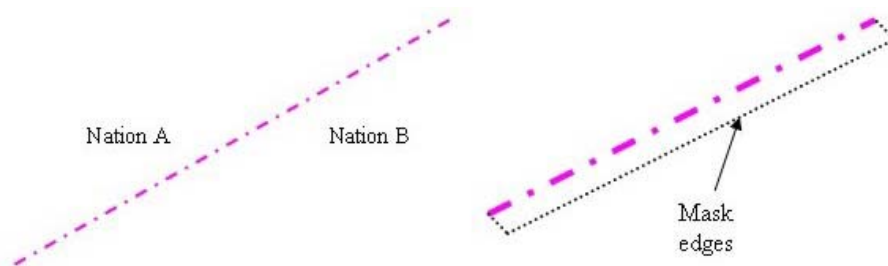

**Figure 22 – Area object with pattern fill**

Compilers must take care that the area is large enough at the compilation scale of the ENC (and at smaller ECDIS display scales at which it is intended that the object should be displayed) so that at least one pattern symbol is displayed in the area. If this is not the case, the boundary of the area should not be masked. Alternatively, a point feature may be encoded instead of the area feature. It may be useful to load and display the ENC in an ECDIS in order to assist with making decisions as to the best encoding option to adopt in individual circumstances.

### 4. “Linear” area objects:

Where it is required to encode a linear feature when the only allowable primitive for the relevant object class is area (e.g. a “linear” maritime jurisdiction area (see clause 11.2)), a “very narrow area” should be encoded. An edge of this area should correspond to the position of the line. All other edges should be masked.



**Figure 23 – “Linear” maritime jurisdiction area**

### 5. Routing measures – entrance and exit edges:

Routing measures such as Traffic Separation Schemes (TSS), Two-Way Routes and Deep Water Routes have defined “ends” through which vessels enter and exit the route. Most routing measures also consist of multiple components having different orientations. Where encoded, many of the objects comprising the routing measure symbolise along the edges of the area. Where the edges corresponding to the entry/exit points and between individual components of the route have not been masked, the impression of the route as a single routing measure may not be apparent to the mariner, and cause confusion. Compilers should therefore mask the entry/exit edges, and all edges between components within the routing measure.

The following table lists those area objects that should have entry/exit edges, and all edges between components within the routing measure masked.

Object-class	Comment
DWRTPT	
FAIRWY	
ISTZNE	Only to be applied when the entrance and/or exit routes are known
RCTLPT	
TSSLPT	
TSSRON	
TWRTPT	
M_COVR	Coverage available, mask full coverage. (No Coverage available, don't mask)
M_NSYS	Mask full coverage. If ORIENT is attributed don't mask.

table 17.2

Figure 24 below shows an example of a TSS with all appropriate edges of the components of the TSS masked.



Figure 24 – Traffic Separation Scheme with appropriate masking

To give an indication of the effect of masking in a complex area such as a maritime area containing a TSS, Figure 24 includes a **CTNARE** object of type area which has not had its edges masked. Due to the existence of the magenta “!” symbols within the **CTNARE**, and the fact that the edges of the

**CTNARE** are coincident with the outer edge of the TSS, it is possible to further reduce ECDIS display clutter by masking the edges of the **CTNARE**. The resultant ECDIS display can be seen in Figure 25 below.

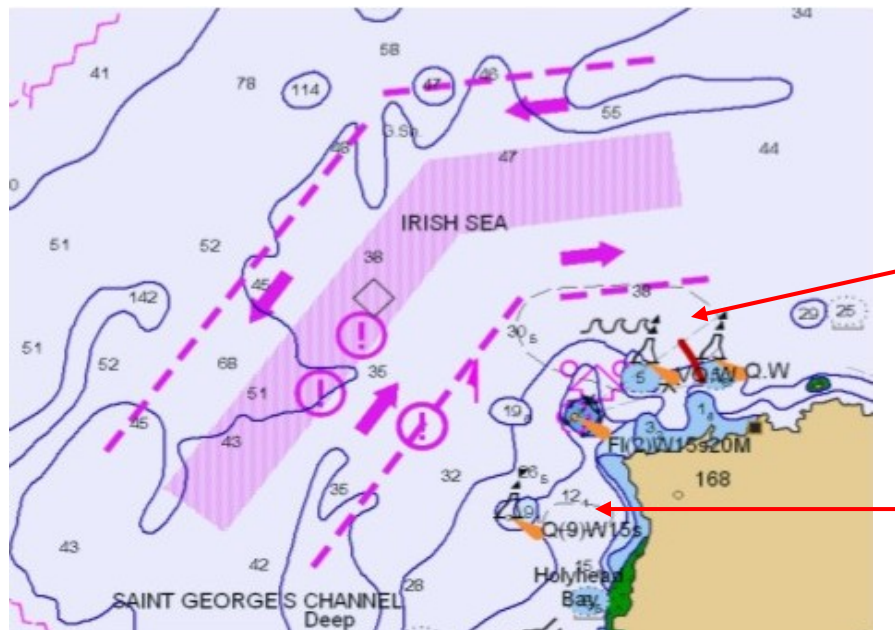

*Figure 25 – Traffic Separation Scheme with masked CTNARE*

NOTE: In the example above it is also possible to mask the areas of water turbulence (indicated in Figure 25 by red arrows – see scenario 3 above), however the small area to the east of the West cardinal buoy is too small to display the symbol at the compilation scale of the ENC. In cases such as this the compiler should consider capturing this feature as a **WATTUR** object of type point.

Page intentionally left blank