

INTERNATIONAL HYDROGRAPHIC ORGANIZATION



BATHYMETRIC SURFACE PRODUCT SPECIFICATION

IHO Publication S-102

Edition 2.0.0 – **Xxxx**, 2019

Published by the
International Hydrographic Organization
4b quai Antoine 1^{er}
Principauté de Monaco
Tel: (377) 93.10.81.00
Fax: (377) 93.10.81.40
E-mail: info@iho.int
Web: www.iho.int

© Copyright International Hydrographic Organization 2019

This work is copyright. Apart from any use permitted in accordance with the Berne Convention for the Protection of Literary and Artistic Works (1886), and except in the circumstances described below, no part may be translated, reproduced by any process, adapted, communicated or commercially exploited without prior written permission from the International Hydrographic Organization (IHO). Copyright in some of the material in this publication may be owned by another party and permission for the translation and/or reproduction of that material must be obtained from the owner.

This document or partial material from this document may be translated, reproduced or distributed for general information, on no more than a cost recovery basis. Copies may not be sold or distributed for profit or gain without prior written agreement of the IHO Secretariat and any other copyright holders.

In the event that this document or partial material from this document is reproduced, translated or distributed under the terms described above, the following statements are to be included:

“Material from IHO publication [reference to extract: Title, Edition] is reproduced with the permission of the IHO Secretariat (Permission No/...) acting for the International Hydrographic Organization (IHO), which does not accept responsibility for the correctness of the material as reproduced: in case of doubt, the IHO’s authentic text shall prevail. The incorporation of material sourced from IHO shall not be construed as constituting an endorsement by IHO of this product.”

“This [document/publication] is a translation of IHO [document/publication] [name]. The IHO has not checked this translation and therefore takes no responsibility for its accuracy. In case of doubt the source version of [name] in [language] should be consulted.”

The IHO Logo or other identifiers shall not be used in any derived product without prior written permission from the IHO Secretariat.

Document History

Version Number	Date	Author	Purpose
1.0.0	April 2012	TSMAD	Approved edition of S-102
2.0.0	March 2017	S-102PT	Updated clause 4.0 and 12.0. Populated clause 9.0 and Annex B.
2.0.0	May 2017	S-102PT	Modified clause 9.0 based on feedback at S-100WG2 meeting.
2.0.0	February 2018	S-102PT	Modified Clause 9.0. Deleted contents of Annex B in preparation for updated S-100 Part 10C guidance. Added Annex F: S-102 Dataset Size and Production, Annex G: Gridding Example, Annex H: Statement added for Multi-Resolution Gridding, Annex I: Statement for future S-102 Tiling.
2.0.0	June 2018	S-102PT	Modifications to align with S-100 v4.0.0, S-100 Part 10c development, and actions from 4 th April S-102 Project Team Meeting. Modified content throughout the following sections: <ul style="list-style-type: none"> - Clause 1, 3, 4, 5, 6, 9, 10, 11, and 12. - Annexes A, B, D, F, G, and I.
2.0.0	October/November 2018	S-102PT	Entered Redline comments from HSSC Letter 02/2018 Modified content includes: <ul style="list-style-type: none"> - Clause 1, 3, 4, 5, 6, 9, 10, 11, and 12. - Annexes A, B, D, F, G, and I.
2.0.0	January/February 2019	S-102PT	Adjudicated HSSC and S102PT Comments at 5 th S-102 Project Team Meeting. Modified content includes: <ul style="list-style-type: none"> - Clause 1, 3, 4, 5, 6, 9, 10, 11, and 12. - Annexes A, B, D, F, G, and I.

Page intentionally left blank

Contents

1	Overview	1
1.1	Introduction	1
1.2	References.....	1
1.3	Terms, definitions and abbreviations	2
1.3.1	Use of Language.....	2
1.3.2	Terms and Definitions	2
1.3.3	Abbreviations	4
1.4	S-102 General Data Product Description	5
1.5	Product Specification Metadata	5
1.6	IHO Product Specification Maintenance	6
1.6.1	Introduction	6
1.6.2	New Edition	6
1.6.3	Revisions.....	6
1.6.4	Clarification	6
1.6.5	Version Numbers	7
2	Specification Scope.....	7
3	Data Product Identification	7
4	Data Content and structure	8
4.1	Introduction	8
4.2	Application Schema	9
4.2.1	Application Schema Implementation Classes.....	11
4.2.2	Tiling Scheme (Partitioning).....	17
4.3	Feature Catalogue	19
4.3.1	Introduction	19
4.3.2	Feature Types.....	19
4.3.3	Feature Relationship	19
4.3.4	Attributes	20
4.4	Dataset Types	20
4.4.1	Introduction	20
4.4.2	Regular Grid.....	20
4.5	Multiple Datasets.....	21
4.6	Dataset Rules.....	21
4.7	Geometry	21
5	Coordinate Reference Systems (CRS)	21
5.1	Introduction	21
5.2	Spatial Reference System	22
5.3	Horizontal Coordinate Reference System.....	22
5.4	Vertical Coordinate Reference System.....	22
5.5	Temporal Reference System	23
6	Data Quality	23
6.1	Completeness	23
6.1.1	Commission	23
6.1.2	Omission	23
6.2	Logical Consistency	23
6.2.1	Conceptual Consistency	23
6.2.2	Domain Consistency	23
6.2.3	Format Consistency	23
6.3	Positional Accuracy.....	24
6.3.1	Accuracy of a Time Measurement	24
6.3.2	Gridded Data Positional Accuracy	24
6.3.3	Relative Internal Positional Accuracy.....	24
6.4	Temporal Accuracy	24
6.4.1	Temporal Consistency	24
6.4.2	Temporal Validity	24

6.5	Thematic Accuracy.....	24
6.5.1	Thematic Classification Correctness.....	24
6.5.2	Non-Quantitative Attribute Accuracy.....	25
6.5.3	Quantitative Attribute Accuracy.....	25
7	Data Capture and Classification	25
8	Data Maintenance	25
8.1	Maintenance and Update Frequency.....	25
8.2	Data Source	25
8.3	Production Process	25
9	Portrayal.....	26
9.1	Introduction	26
9.2	Generation and Display of Gridded Bathymetry	26
9.2.1	Charted Soundings/Contours vs. Gridded Bathymetry.....	26
9.2.2	Use of Sun-Illumination	26
9.2.3	Transparency	27
9.3	Generation and Display of Navigation Zones	27
10	Data Product Format (Encoding)	28
10.1	Introduction	28
10.2	Product Structure	29
10.2.1	Feature Codes (Group_F).....	31
10.2.2	Values Groups (Group_nnn).....	31
10.2.3	Data Arrays	31
10.2.4	Summary of Generalized Dimensions	32
10.2.5	Mandatory Naming Conventions.....	32
10.3	Sample HDF5 Encoding	32
11	Data Product Delivery	32
11.1	Introduction	32
11.2	Dataset.....	33
11.2.1	Dataset Management.....	33
11.2.2	Dataset Size.....	33
11.2.3	Dataset file naming	34
11.3	Exchange Catalogue.....	34
11.4	Data integrity and encryption	34
11.4.1	Use of Compression.....	34
11.4.2	Use of Data Protection	35
11.4.3	Use of Digital Signatures	35
12	Metadata	35
12.1	Introduction	35
12.2	Discovery Metadata	38
12.3	Structure Metadata.....	42
12.3.1	Quality Metadata	45
12.3.2	Acquisition Metadata.....	46
12.4	Exchange Set Metadata.....	47
12.5	Language	49
12.6	S102_ExchangeCatalogue	51
12.6.1	S100_CatalogueIdentifier	52
12.6.2	S100_CataloguePointofContact.....	52
12.7	S102_DatasetDiscoveryMetadata	52
12.7.1	S100_DataCoverage.....	56
12.7.2	S100_DigitalSignature	56
12.7.3	S100_DigitalSignatureValue	56
12.7.4	S100_VerticalAndSoundingDatum	57
12.7.5	S100_DataFormat.....	58
12.7.6	S100_ProductSpecification.....	59
12.7.7	S100_ProtectionScheme	59
12.7.8	S102_GriddingMethod	59
12.8	S102_CatalogueMetadata	61

12.8.1	S102_CatalogueScope	62
12.8.2	PT_Locale	62
Annex A.	Data Classification and Encoding Guide	63
A-1	Features	63
A-2	Feature Attributes.....	64
Annex B.	HDF-5 Encoding	67
B-1	General Structure.....	67
B-1.1	BathymetryCoverage	68
B-1.2	TrackingListCoverage	78
Annex C.	Normative Implementation Guidance	79
Annex D.	Feature Catalogue	81
Annex E.	Portrayal Catalogue	83
Annex F.	S-102 Dataset Size and Production.....	85
F-1	Header Record.....	85
F-2	Data Records/Nodes.....	85
F-3	File Estimates.....	85
Annex G.	S-102 Gridding Methods	89
Annex H.	Multi-Resolution Gridding.....	91
Annex I.	Gridding Full Resolution Source Bathymetry and its Relationship to a Charted Sounding.....	93
I-1	Modern High-Resolution Hydrographic Multibeam Sonars.....	93
I-1.1	Example Collection Scenario	93
I-2	Survey Metrics	93
I-2.1	Ping Rate and Number of Depth Estimates.....	93
I-2.2	Sonar Footprint	93
I-2.3	Sonar Coverage	94
I-3	Post Survey Process.....	95
I-3.1	High-Density Processing Grid.....	95
I-3.2	Generation of a Production Grid	95

Page intentionally left blank

1 Overview

With the advent of electronic navigation and the technological progress of surveying systems and production capabilities, the ability to enhance maritime navigation with the portrayal of high resolution bathymetry has become a requirement. The provision and utilization of such data in a standardized format is essential to support the safe and precise navigation of marine vessels, and furthermore an important basis for many other maritime applications.

1.1 Introduction

This document describes an S-100 compliant product specification for a bathymetric surface product. Incorporating aspects of the navigation surface concept [Smith et al, 2002], an S-102 bathymetric surface product is a digital elevation model which represents the seafloor in a regular grid structure. It can be used alone or as an important element/source for future S-100 conformant ECDIS navigation. The product specification is based on the IHO S-100 framework specification and the ISO 19100 series of standards. It comprises the content model (spatial structure and metadata), encoding structure, portrayal and exchange file format for a bathymetric surface product.

1.2 References

- IHO S-100 Universal Hydrographic Data Model v4.0.0, December 2018 (Encoding, Feature Catalogue)
- IHO S-44 Standards for Hydrographic Surveys 5th Edition, February 2008
- IHO S-4 Regulations of the IHO for International (INT) Charts and Chart Specifications of the IHO, Edition 4.8.0, October/November 2018.
- IHO S-32 Hydrographic Dictionary 5th Edition, Part 1, Volume 1 (English), 1994
- ISO 8601:2004** Data elements and interchange formats - Information interchange - Representation of dates and times
- ISO/TS 19103:2015** Geographic information - Conceptual schema language
- ISO 19111:2007** Geographic information - Spatial referencing by coordinates
- ISO 19115-1:2014/Amd 1:2018 Geographic information - Metadata
- ISO 19115-2:2009** Geographic information - Metadata: Extensions for imagery and gridded data
- ISO 19123:2005** Geographic information - Schema for coverage geometry and functions
- ISO 19129:2009** Geographic information - Imagery gridded and coverage data framework
- ISO 19131:2007/Amd 1:2011** Geographic information - Data product specifications
- ISO/IEC 19501:2005** Information technology - Open Distributed Processing - Unified Modelling Language Version 1.4.2

Smith, Shep M. LT; Alexander, Lee; and Armstrong, Andy, "The Navigation Surface: A New Database Approach to Creating Multiple Products from High-Density Surveys" (2002). International Hydrographic Review. <http://scholars.unh.edu/ccom/976>

Calder, Brian; Byrne, Shannon; Lamey, Bill; Brennan, Richard T.; Case, James D.; Fabre, David; Gallagher, Barry; Ladner, Wade R.; Moggert, Friedhelm; and Patron, Mark, "The Open Navigation Surface Project" (2005).

International Hydrographic Review. <https://scholars.unh.edu/ccom/1011>

1.3 Terms, definitions and abbreviations

1.3.1 Use of Language

Within this document:

- “Must” indicates a mandatory requirement.
- “Should” indicates an optional requirement, that is the recommended process to be followed, but is not mandatory.
- “May” means “allowed to” or “could possibly” and is not mandatory.

1.3.2 Terms and Definitions

Accuracy

Closeness of agreement between a test result and the accepted reference values.

NOTE: A test result can be from an observation or measurement.

Coordinate

One of a sequence of n numbers designating the position of a point in N-dimensional space.

NOTE: The numbers must be qualified by units.

Coordinate Reference System

Coordinate system which is related to the real world by a datum.

Coverage

Feature that acts as a function to return values from its range for any direct position within its spatial, temporal, or **spatiotemporal domain**.

NOTE: In other words, a coverage is a feature that has multiple values for each attribute type, where each direct position within the geometric representation of the feature has a single value for each attribute type.

EXAMPLE: Examples include a digital image, polygon overlay, or digital elevation matrix

Coverage Geometry

Configuration of the **domain** of a **coverage** described in terms of **coordinates**.

Direct Position

Position described by a single set of **coordinates** within a **coordinate reference system**.

Domain

Well-defined set.

NOTE: Domains are used to define the domain set and range set of attributes, operators and functions.

Depth

The vertical distance from a given water level to the bottom.

Feature

Abstraction of real world phenomena.

NOTE: A feature may occur as a type or an instance. Feature type or feature instance should be used when only one is meant.

Feature Attribute

Characteristic of a **feature**.

NOTE: A feature attribute type has a name, a data type and a domain associated to it. A feature attribute instance has an attribute value taken from the value domain of the feature attribute type.

Function

Rule that associates each element from a **domain** (source, or domain of the function) to a unique element in another domain (target, co-domain, or **range**).

NOTE: The range is defined by another domain.

Geometric Object

Spatial object representing a set of **direct positions**

NOTE: A geometric object consists of a geometric primitive, a collection of geometric primitives, or a geometric complex treated as a single entity. A geometric object may be the spatial characteristics of an object such as a feature or a significant part of a feature.

Grid

Network composed of two or more sets of curves in which the members of each set intersect the members of the other sets in a systematic way.

NOTE: The curves partition a space into grid cells.

Grid Point

Point located at the intersection of two or more curves in a **grid**.

LIDAR

An optical remote sensing technique that uses a laser pulse to determine distance.

NOTE: LIDAR may be used to determine depth in shallow water areas.

Navigation Surface

A **coverage** representing the bathymetry and associated uncertainty with the methods by which those objects can be manipulated, combined and used for a number of tasks, certified for safety of navigation

Range <coverage>

Set of values associated by a **function** with the elements of the **spatiotemporal domain** of a **coverage**.

Record

Finite, named collection of related items (objects or values).

NOTE: Logically, a record is a set of pairs <name, item >.

Rectified Grid

Grid for which there is a linear relationship between the **grid coordinates** and the **coordinates** of an external **coordinate reference system**.

NOTE: If the coordinate reference system is related to the earth by a datum, the grid is a georectified grid.

Referenceable Grid

Grid associated with a transformation that can be used to convert **grid coordinate** values to values of **coordinates** referenced to an **external coordinate reference system**.

SONAR

A technique that uses sound propagation through water to determine distance, primarily **depth** measurement.

Spatiotemporal Domain <coverage>

Domain composed of **geometric objects** described in terms of spatial and/or temporal **coordinates**.

NOTE: The spatiotemporal domain of a continuous coverage consists of a set of direct positions defined in relation to a collection of geometric objects.

Surface

Connected 2-dimensional geometric primitive, representing the continuous image of a region of a plane.

NOTE: The boundary of a surface is the set of oriented, closed curves that delineate the limits of the surface.

Tiling Scheme

A discrete **grid coverage** that is used to partition data into discrete edge matched sets called tiles.

Uncertainty

The interval (about a given value) that will contain the true value of the measurement at a specific confidence level.

NOTE: Errors exist and are the differences between the measured value and the true value. Since the true value is never known it follows that the error itself cannot be known. Uncertainty is a statistical assessment of the likely magnitude of this error.

Vector

Quantity having direction as well as magnitude.

NOTE: A directed line segment represents a vector if the length and direction of the line segment are equal to the magnitude and direction of the vector. The term vector data refers to data that represents the spatial configuration of features as a set of directed line segments.

1.3.3 Abbreviations

This product specification adopts the following convention for presentation purposes:

API	Application Programming Interface
DS	Digital Signature
ECDIS	Electronic Chart Display Information System
ECS	Electronic Chart System
ENC	Electronic Navigational Chart
GML	Geography Markup Language
IHO	International Hydrographic Organization
ISO	International Standards Organization
LIDAR	Light Detection and Ranging
NS	Navigation Surface
ONS	Open Navigation Surface
PK	Public Key

SA	Signature Authority
SK	Secret Key
SONAR	Sound Navigation and Ranging
UML	Universal Modelling Language

1.4 S-102 General Data Product Description

Title: Bathymetric Surface Product Specification

Abstract: This document is a Product Specification for a bathymetric surface which may be used alone or as an important element/source for future S-100 conformant ECDIS navigation. The product is defined as a data set with different coverages. This Product Specification includes a content model and separate encodings.

Content: The Product Specification defines all requirements to which S-102 bathymetric data products must conform. Specifically, it defines the data product content in terms of features and attributes within the feature catalogue. The display of features is defined by the symbols and rule sets contained in the portrayal catalogue. The Data Classification and Encoding Guide (DCEG) provides guidance on how data product content must be captured. Annex A, in addition to Annex C, will provide implementation guidance for developers.

Spatial Extent:

Description: Areas specific to marine navigation.

East Bounding Longitude: 180°

West Bounding Longitude: -180°

North Bounding Latitude: 90°

South Bounding Latitude: -90°

Specific Purpose: The primary purpose of the Bathymetric Surface Product is to provide high resolution bathymetry in gridded form in support of safety of navigation. A Bathymetric Surface Product may exist anywhere in the maritime domain. There are no limitations to its extent. Portrayal of S-102 bathymetry with other S-100 compliant products are intended to support safe passage, precise berthing and mooring, as well as route planning of marine vessels. The secondary purpose of a bathymetric surface product is to provide high resolution bathymetric data for other maritime applications.

1.5 Product Specification Metadata

This information uniquely identifies this Product Specification and provides information about its creation and maintenance. For further information on dataset metadata, see Clause 12 - Metadata.

Title: Bathymetric Surface Product Specification

S-100 Version: 4.0.0

S-102 Version: 2.0.0

Date: Xxxx 2019

Language: English

Classification: Unclassified

Contact: International Hydrographic Bureau
4 Quai Antoine 1er
B.P. 445
MC 98011 MONACO CEDEX
Telephone: +377 93 10 81 00
Fax: + 377 93 10 81 40
Email: info@iho.int

URL: www.iho.int

Identifier: IHO:S100:S102:2:0:0

Maintenance: Changes to the Product Specification S-201 are coordinated by the IHO S-100 Working Group (S-100WG), and must be made available via the IHO web site. Maintenance of the Product Specification must conform to IHO Resolution 2/2007, as amended.

1.6 IHO Product Specification Maintenance

1.6.1 Introduction

Changes to S-102 will be released by the IHO as a New Edition, revision, or clarification.

1.6.2 New Edition

New Editions of S-102 introduce significant changes. *New Editions* enable new concepts, such as the ability to support new functions or applications, or the introduction of new constructs or data types. *New Editions* are likely to have a significant impact on either existing users or future users of S-102.

1.6.3 Revisions

Revisions are defined as substantive semantic changes to S-102. Typically, revisions will change S-102 to correct factual errors; introduce necessary changes that have become evident as a result of practical experience or changing circumstances. A *revision* must not be classified as a clarification. *Revisions* could have an impact on either existing users or future users of S-102. All cumulative *clarifications* must be included with the release of approved corrections revisions.

Changes in a revision are minor and ensure backward compatibility with the previous versions within the same Edition. Newer revisions, for example, introduce new features and attributes. Within the same Edition, a dataset of one version could always be processed with a later version of the feature and portrayal catalogues.

In most cases a new feature or portrayal catalogue will result in a revision of S-102.

1.6.4 Clarification

Clarifications are non-substantive changes to S-102. Typically, clarifications: remove ambiguity; correct grammatical and spelling errors; amend or update cross references; insert improved graphics in spelling, punctuation and grammar. A clarification must not cause any substantive semantic change to S-102.

Changes in a clarification are minor and ensure backward compatibility with the previous versions within the same Edition. Within the same Edition, a dataset of one clarification version could always be processed with a later version of the feature and portrayal catalogues, and a portrayal catalogue can always rely on earlier versions of the feature catalogues.

1.6.5 Version Numbers

The associated version control numbering to identify changes (n) to S-102 must be as follows:

New Editions denoted as **n.0.0**

Revisions denoted as n.**n**.0

Clarifications denoted as n.n.**n**

2 Specification Scope

This product specification defines only one general scope which applies to all its sections.

Scope Identification: GeneralScope

3 Data Product Identification

Title:	Bathymetric Surface
Abstract:	The Bathymetric Surface Product consists of a set of values organized to form a regular grid coverage, with associated metadata, for an area of the sea, river, lake or other navigable water. Final grid coverage includes a depth value and associated uncertainty estimate for each location in the matrix. In addition, a discrete point set called a "tracking list" is included. The tracking list contains locations where a hydrographer or the data producer overrode a grid matrix value to deliberately bias the final surface for safety of navigation. That is, the data set can carry both the corrected depth information to support the safe navigation of marine vessels as well as the original measured depth value to support scientific purposes.
Topic Category:	Main topics for the product, as according to ISO/IEC 19115-1 MD_TopicCategoryCode: 006 – elevation 014 – oceans 012 – inlandWaters
Geographic Description:	Areas specific to marine navigation.
Spatial Resolution:	The spatial resolution, or the spatial dimension on the earth covered by the size of a grid matrix cell (nominal ground sample distance), varies according to the model adopted by

the producer (hydrographic office).

Purpose:	The primary purpose of the bathymetric surface product is to provide high resolution bathymetry in gridded form in support of safety of navigation. The secondary purpose is to provide high resolution bathymetry for other maritime applications.
Language:	English (Mandatory), other (Optional)
Classification:	Data can be classified as one of the following: <ol style="list-style-type: none"> 1) Unclassified; 2) Restricted; 3) Confidential; 4) Secret; 5) Top Secret; 6) Sensitive but unclassified; 7) For official use only; 8) Protected; or 9) Limited distribution.
Spatial Representation Type:	Type of spatial representation for the product, as defined by the ISO 19115 MD_SpatialRepresentationTypeCode: 002 - grid.
Point of Contact:	Producing Agency

4 Data Content and structure

4.1 Introduction

The Bathymetric Surface Product incorporates aspects of the Navigation Surface concept where in addition to estimation of depth, an optional estimate of the uncertainty associated with the depth can be computed and preserved. To make the system suitable to support safety of navigation applications, there is a means to over-ride any automatically constructed depth estimates with 'Hydrographer Privilege, (essentially, a means to specify directly the depth determined by a human observer as being the most significant in the area - irrespective of any statistical evidence to the contrary). The original grid values that are replaced by the hydrographer are preserved in the tracking list so that they can be restored if required.

Figure 4.1 below shows a high-level overview of the structure of S-102. It shows that the Bathymetric Surface Product consists of a set of data comprising the HDF5 datasets plus a Digital Certification Block. The Digital Certification Block is mandatory when the data product is produced for navigational purposes so that the user can trace whether the data has been certified. The HDF5 file consists of metadata (spatial, feature and discovery), collocated coverages consisting of depth and uncertainty values, and a tracking list of overridden nodes. S-102 uses the S-100 Data Protection Scheme to ensure certification and authentication.

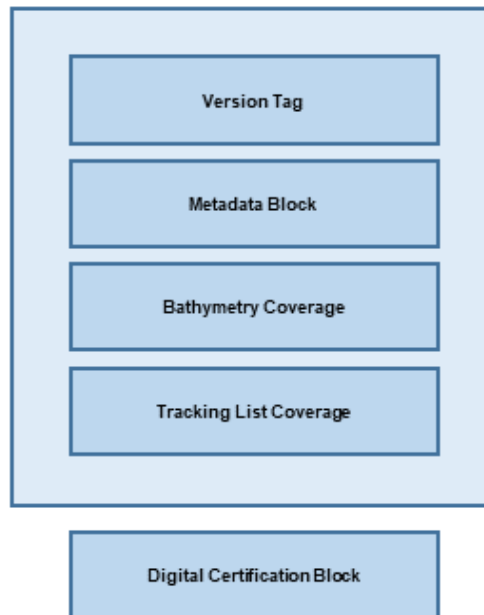

Figure 4.1 - Overview Structure of S-102

Thus, the Bathymetric Surface Product is a hybrid of coverage(s), as defined in IHO S-100 Part 8, and Information Types as defined in IHO S-100 Part 4, together with a point set tracking list. This is described in clause 4.2.

4.2 Application Schema

The Application Schema for S-102 is a template Application Schema. That is, it does not resolve all attributes and allows some choice. This means that an implementer, such as a national hydrographic office, can produce another application schema as a profile of this application schema that makes additional choices. For example, the choice of whether to use a tiling scheme and which tiling scheme to use is left open. An implementer, such as a national hydrographic office, can select the tiling scheme, extent, resolution and other parameters most appropriate for their situation. Since the general structure is defined by the template Application Schema, common software that supports the S-102 template schema is able to support national and other more specific profiles.

The Application Schema Data Set Structure is shown in Figures 4.2 and 4.3. They show a number of classes specialized for use in S-102 and two sets of implementation classes. An actual data set of S-102 bathymetry data only contains the implementation classes. All of the required attributes from the other classes in the application schema are satisfied by statements within the Product Specification. This approach to producing the Application Schema results in a very simple structure for implementation.

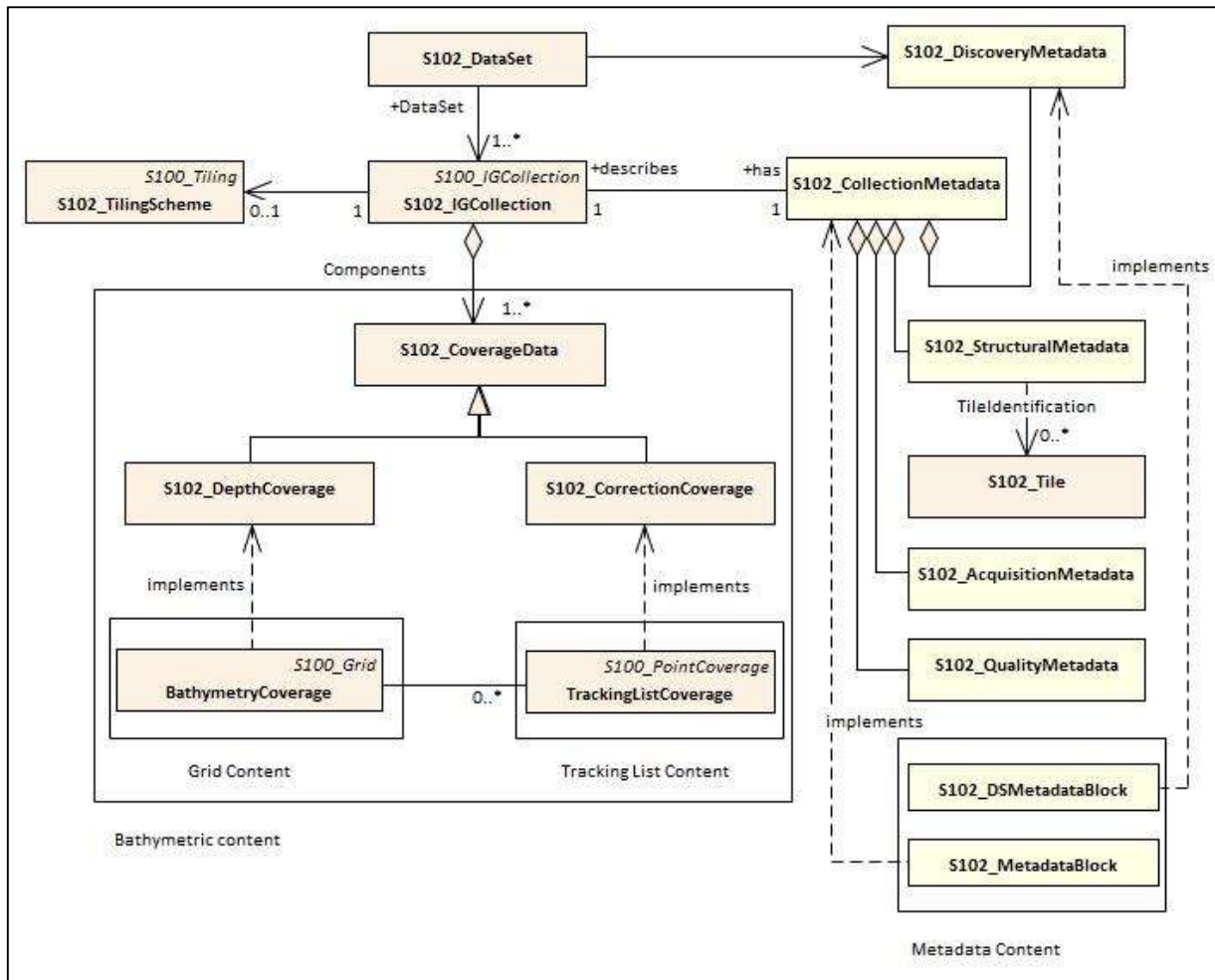

Figure 4.2 - Data Set Structure of S-102

The model in Figure 4.2 states that:

- An S-102 data set (**S102_DataSet**), which is inherited from **S100_DataSet**, references an S-102 Image and Gridded Data Collection (**S102_IgCollection**). The relationship allows a 1 to many (**1..***) multiplicity which means that there may be multiple instances of S-102 data collections. Each collection may or may not correspond to a tiling scheme, and each S102 Dataset would correspond to a single tile. The S-102 discovery metadata class (**S102_DiscoveryMetadata**) describes the metadata entities required for the identification of the entire data set. The required discovery metadata is implemented through the **S102_DS_MetadataBlock** class.
- An instance of an S-102 Image and Gridded Data Collection (**S102_IgCollection**) which is a subtype of **S100_IgCollection**, is described by a set of S-102 Collection Metadata (**S102_CollectionMetadata**). This relationship is 1 to 1 meaning that there is one set of collection metadata for each instance of **S102_IgCollection**. There is a large choice of metadata that may be used in a S-100 compliant data product. Only a small amount of this metadata is mandated by ISO 19115 for discovery. The choice of metadata is discussed in clause 9.2.5. Much of the metadata can be resolved as part of the product specification. Only that metadata that varies IG_collection item needs be included in the S102_MetadataBlock implementation class.
- An S-102 Image and Gridded Data Collection also optionally makes reference to a tiling scheme.

This is discussed further in clause 4.2.2.

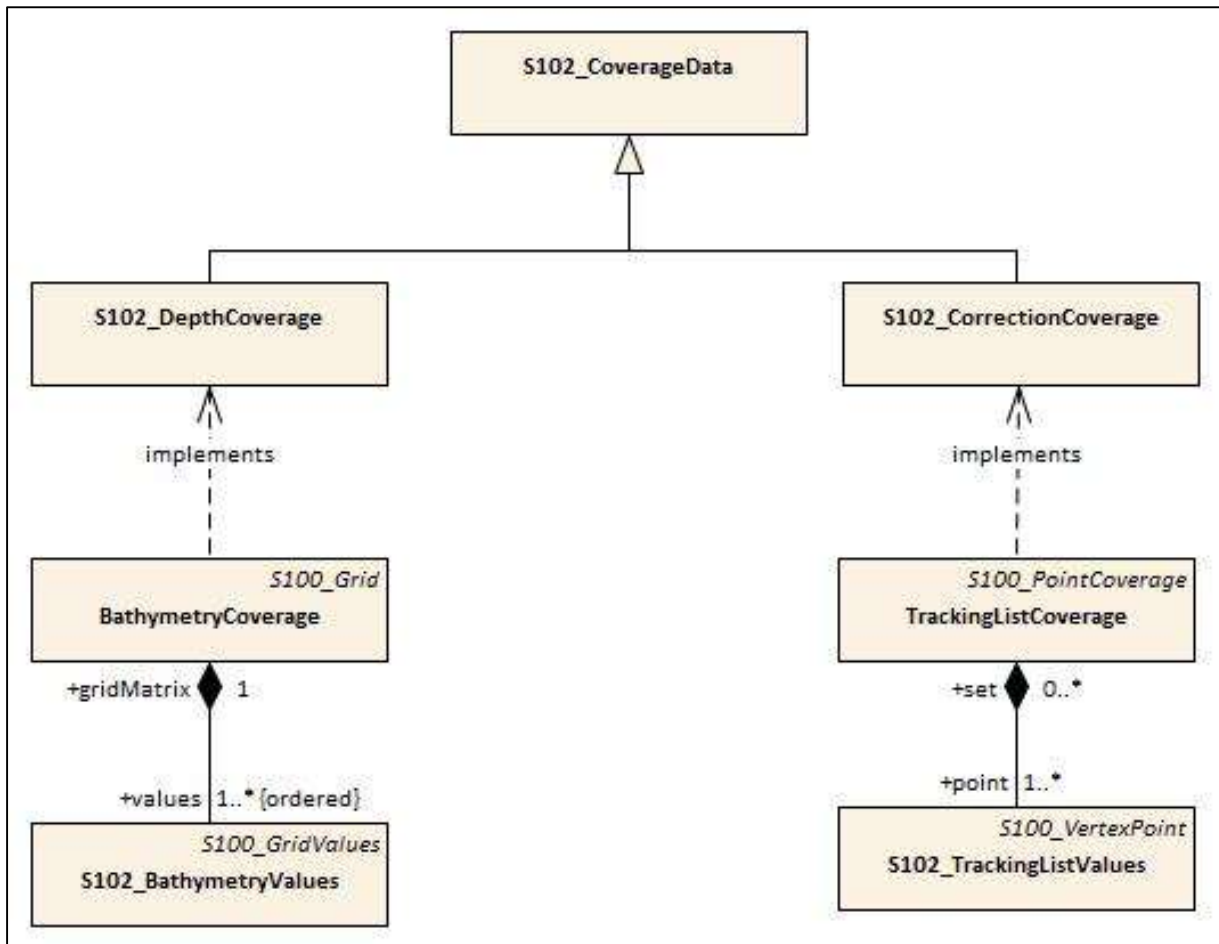

Figure 4.3 - Coverage Structure of S-102

The model in Figure 4.3 depicts two coverage types in this application schema:

- The first coverage type is a discrete Regular Grid Coverage called **S102_DepthCoverage** which inherits from (**S100_GridCoverage**). Many of the parameters of the coverage are described in the product specification. The implementation classes are co-registered, co-geospatially located datasets.
- The second coverage type is a discrete point set coverage called **S102_CorrectionCoverage**. The **S102_CorrectionCoverage** consists of a set of discrete points that correspond to locations which had corrective overrides applied. (I.E. A hydrographer may explicitly specify depth values at specific points to deliberately ensure safety of navigation.) The conflation function simply replaces specific values from the S102_BathymetryValues grid values matrix with the corresponding overriding values.

4.2.1 Application Schema Implementation Classes

The implementation classes for the template application schema are shown in Figure 4.4. The attributes are shown for the coverage related classes together with the attribute classes.

In order to simplify the implementation a number of defaults are assumed for S-102. These defaults simplify implementation and help simplify interaction with the Navigation Surface implementation from the Open Navigation Surface Working Group and other bathymetric gridded types. In the following sub clauses, the default values are emphasized so that they do not need to be encoded when generating an encoding of the implementation classes. However, if specified they must assume the stated values unless other options are stated.

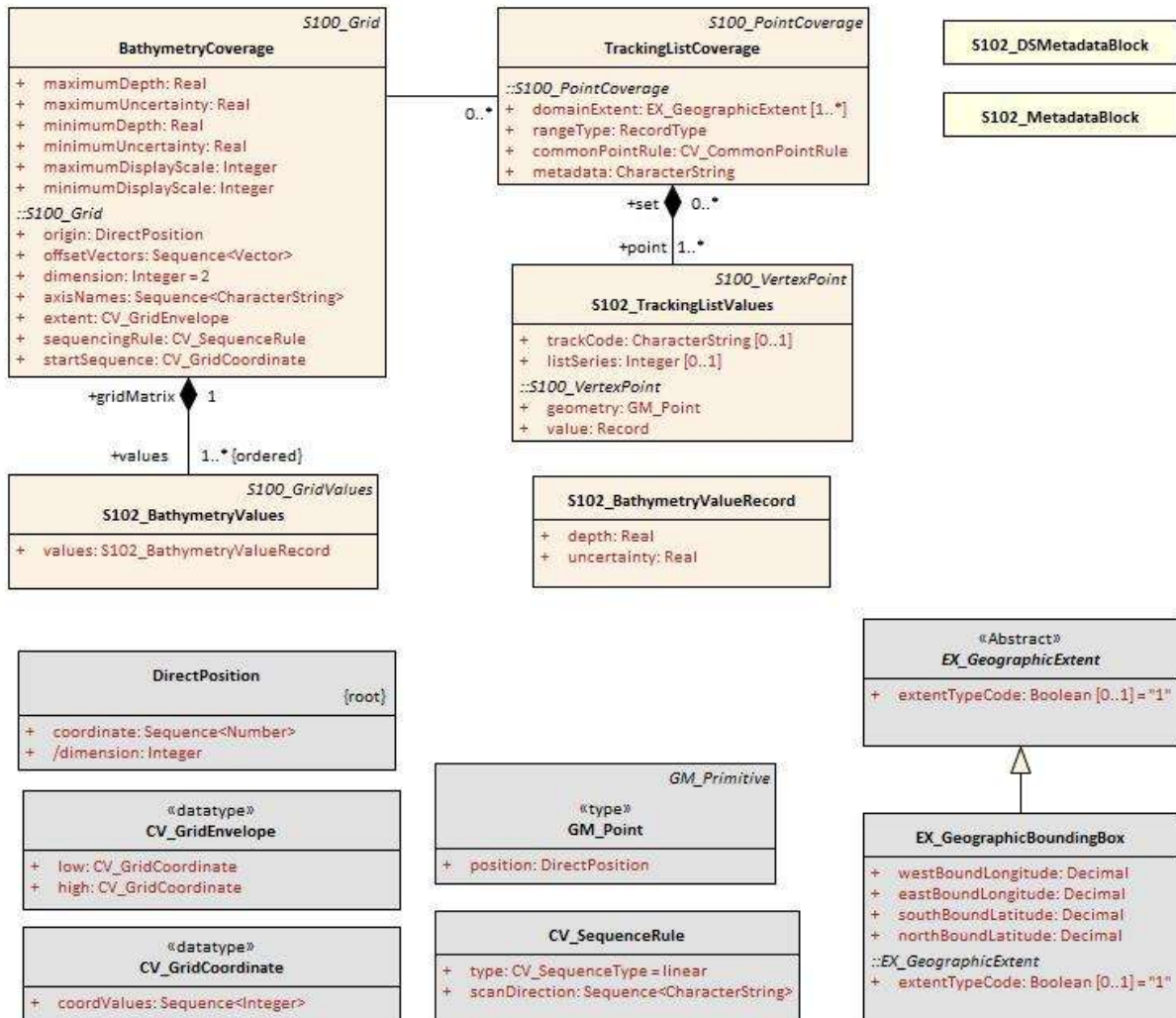

Figure 4.4 - Implementation of Classes of S-102

4.2.1.1 Implementation Classes Description

4.2.1.1.1 BathymetryCoverage

4.2.1.1.1.1 BathymetryCoverage semantics

The class **BathymetryCoverage** has the attributes *minimumDepth*, *maximumDepth*, *minimumUncertainty*, and *maximumUncertainty* which bound the *depth* attribute and the *uncertainty* attribute from the **S102_BathymetryValues** record. **BathymetryCoverage** also contains the attributes *minimumDisplayScale* and *maximumDisplayScale* which define the appropriate scale range for the coverage. **BathymetryCoverage** additionally contains the inherited attributes *origin*, *offsetVectors*, *dimension*, *axisName*, *extent*, *sequenceRule*, and *startSequence* from **S100_Grid** and **CV_Grid**.

The origin is a position in a specified coordinate reference system, and a set of offset vectors specify the direction and distance between the grid lines. It also contains the additional geometric characteristics of a rectified grid.

4.2.1.1.1.2 maximumDisplayScale

The smaller value of the ratio of the linear dimensions of the features of a dataset presented in the display and the actual dimensions of the features represented (smallest scale) of the scale range of the dataset. A list of display scale ranges is available in Table 11.1, 1st column.

4.2.1.1.1.3 minimumDepth

The attribute *minimumDepth* has the value type *Real* and describes the lower bound of the depth estimate for all the *depth* values in **S102_BathymetryValues** record. This attribute is required. There is no default.

4.2.1.1.1.4 maximumDepth

The attribute *maximumDepth* has the value type *Real* and describes the upper bound of the depth estimate for all the *depth* values in **S102_BathymetryValues** record. This attribute is required. There is no default.

4.2.1.1.1.5 minimumDisplayScale

The larger value of the ratio of the linear dimensions of the features of a dataset presented in the display and the actual dimensions of the features represented (largest scale) of the scale range of the dataset. A list of display scale ranges is available in Figure 11.1, 1st column.

4.2.1.1.1.6 minimumUncertainty

The attribute *minimumUncertainty* has the value type *Real* and describes the lower bound of the uncertainty of the depth estimate for all the *depth* values in **S102_BathymetryValues** record. This attribute is required. There is no default.

4.2.1.1.1.7 maximumUncertainty

The attribute *maximumUncertainty* has the value type *Real* and describes the upper bound of the uncertainty of the depth estimate for all the *depth* values in **S102_BathymetryValues** record. This attribute is required. There is no default.

4.2.1.1.1.8 origin

The attribute *origin* has the value class *DirectPosition* which is a position that shall locate the origin of the rectified grid in the coordinate reference system. This attribute is required. There is no default.

4.2.1.1.1.9 offsetVectors

The attribute *offsetVectors* has the value class *Sequence<Vector>* that shall be a sequence of offset vector elements that determine the grid spacing in each direction. The data type *Vector* is specified in ISO/TS 19103. This attribute is required. There is no default.

4.2.1.1.1.10 dimension

The attribute *dimension* has the value class *Integer* that shall identify the dimensionality of the grid. The value of the grid dimension in this product specification is 2. This value is fixed in this Product Specification and does not need to be encoded.

4.2.1.1.1.11 axisNames

The attribute *axisNames* has the value class *Sequence<CharacterString>* that shall be used to assign names to the grid axis. The grid axis names shall be "Latitude" and "Longitude" for unprojected data sets or "Northing" and "Easting" in a projected space.

4.2.1.1.1.12 extent

The attribute *extent* has the value class **CV_GridEnvelope** that shall contain the extent of the spatial domain of the coverage. It uses the value class **CV_GridEnvelope** which provides the grid coordinate values for the diametrically opposed corners of the grid. The default is that this value is derived from the bounding box for the data set or tile in a multi tile data set.

4.2.1.1.1.13 sequencingRule

The attribute *sequencingRule* has the value class **CV_SequenceRule** that shall describe how the grid points are ordered for association to the elements of the sequence values. The default value is "Linear". No other options are allowed.

4.2.1.1.1.14 startSequence

The attribute *startSequence* has the value class **CV_GridCoordinate** that shall identify the grid point to be associated with the first record in the values sequence. The default value is the lower left corner of the grid. No other options are allowed.

4.2.1.1.2 S102_BathymetryValues

4.2.1.1.2.1 S102_BathymetryValues semantics

The class **S102_BathymetryValues** is related to **BathymetryCoverage** by a composition relationship in which an ordered sequence of *depth* values provide data values for each grid cell. The class **S102_BathymetryValues** inherits from S100_Grid.

4.2.1.1.2.2 values

The attribute *values* has the value type **S102_BathymetryValueRecord** which is a sequence of value items that shall assign values to the grid points. There are two attributes in the bathymetry value record, *depth* and *uncertainty* in the **S102_BathymetryValues** class. The definition for the *depth* is defined by the *depthCorrectionType* attribute in the **S102_DataIdentification** class. The definition of the type of data in the values record is defined by the *verticalUncertaintyType* attribute in the **S102_DataIdentification** class.

4.2.1.1.3 DirectPosition

4.2.1.1.3.1 DirectPosition semantics

The class **DirectPosition** hold the coordinates for a position within some coordinate reference system.

4.2.1.1.3.2 coordinate

The attribute *coordinate* is a sequence of Numbers that hold the coordinate of this position in the specified reference system.

4.2.1.1.3.3 dimension

The attribute *dimension* is a derived attribute that describes the length of coordinate.

4.2.1.1.4 CV_GridEnvelope

4.2.1.1.4.1 CV_GridEnvelope semantics

The class **CV_GridEnvelope** provides the grid coordinate values for the diametrically opposed corners of an envelope that bounds a grid. It has two attributes.

4.2.1.1.4.2 low

The attribute *low* shall be the minimal coordinate values for all grid points within the envelope. For this specification this represents the Southwestern coordinate.

4.2.1.1.4.3 high

The attribute *high* shall be the maximal coordinate values for all grid points within the envelope. For this specification this represents the Northeastern coordinate.

4.2.1.1.5 CV_GridCoordinate

4.2.1.1.5.1 CV_GridCoordinate semantics

The class **CV_GridCoordinate** is a data type for holding the grid coordinates of a **CV_GridPoint**.

4.2.1.1.5.2 coordValues

The attribute *coordValues* has the value class *Sequence<Integer>* that shall hold one integer value for each dimension of the grid. The ordering of these coordinate values shall be the same as that of the elements of *axisNames*. The value of a single coordinate shall be the number of offsets from the origin of the grid in the direction of a specific axis.

4.2.1.1.6 CV_SequenceRule

4.2.1.1.6.1 CV_SequenceRule semantics

The class **CV_SequenceRule** contains information for mapping grid coordinates to a position within the sequence of records of feature attribute values. It has two attributes.

4.2.1.1.6.2 type

The attribute *type* shall identify the type of sequencing method that shall be used. A code list of scan types is provided in S-100 Part 8. Only the value —linearll shall be used in S-102, which describes scanning row by row by column.

4.2.1.1.7 scanDirection

The attribute *scanDirection* has the value class *Sequence<CharacterString>* a list of axis names that indicates the order in which grid points shall be mapped to position within the sequence of records of feature attribute values. The scan direction for all layers in S-102 is "Longitude" and "Latitude" or west to east, then south to north.

4.2.1.1.8 TrackingListCoverage

4.2.1.1.8.1 TrackingListCoverage semantics

The class **TrackingListCoverage** has the attributes *domainExtent*, *rangeType*, *CommonPointRule* and *metadata* inherited from **S100_PointCoverage**. The **TrackingListCoverage** is a discrete point coverage which is used to track overridden nodes in the **BathymetryCoverage** by allowing a hydrographer to apply a bias for safety of navigation. The attribute *metadata* provides one method of linking the metadata to the coverage inherited from S-100, however it is not required in S-102 because there is no need for specific metadata at the feature (class) level. The attribute *commonPointRule* is also not required because the value has been established for the whole of the S-102 data product to be "average". The attribute *rangeType* takes on the value class *RecordType*. This is modelled by the composition of multiple instances of **S102_TrackingListValues**. Therefore, only the attribute *domainExtent* is required, and it has a default value.

4.2.1.1.8.2 domainExtent

The attribute *domainExtent* has the value class *EX_GeographicExtent* which describes the spatial boundaries of the tracking list elements within the bounds established by *CV_GridEnvelope* for the **BathymetryCoverage**. The default is the bounds established by the attribute CV_GridEnvelope.

4.2.1.1.9 S102_TrackingListValues

4.2.1.1.9.1 S102_TrackingListValues semantics

The class **S102_TrackingListValues** has the attributes *trackCode* and *listSeries*, and the attributes *geometry*, and *value* inherited from **S100_VertexPoint** and **CV_GeometryValuePair**. The tracking list is a discrete coverage used to furnish the set of values that were overridden in the **S102_BathymetryValues** class. To assure alignment of tracking list values with the grid cells in the bathymetry coverage grid, the reference system for the tracking list is the bathymetry coverage regular grid.

The *trackCode* value and the *listSeries* value provide context for the override a value from the bathymetry coverage. The *trackCode* value is a text string that describes the reason for the override.

4.2.1.1.9.2 trackCode

The optional attribute *trackCode* has the value type *CharacterString* which may contain a text string describing the reason for the override of the corresponding *depth* and *uncertainty* values in the bathymetry coverage. This is a user definable field with values defined in the lineage metadata.

4.2.1.1.9.3 listSeries

The attribute *listSeries* has the value type *Integer* which contains an index number into a list of metadata elements describing the reason for the override of the corresponding *depth* and *uncertainty* values in the bathymetry coverage.

4.2.1.1.9.4 geometry

The attribute *geometry* has the value class **GM_Point** which is a position that shall locate the tracking list value. When the **TrackingListCoverage** discrete coverage and the **BathymetryCoverage** are conflated the values that are overridden in the sequence of the attribute **S102_BathymetryValues** are located by position. The value class is **GM_Point** which is the x, y grid post coordinate of the coverage.

4.2.1.1.9.5 value

The attribute *value* has the value class *Record* which is a sequence of value items that shall assign values to the discrete grid point. There are two values in each record in the **S102_TrackingListValues** class. These are the *depth* and the *uncertainty* values that were overridden in corresponding grid coverages.

4.2.1.1.10 GM_Point

4.2.1.1.10.1 GM_Point semantics

The class **GM_Point** is taken from ISO 19107 and is the basic data type for a geometric object consisting of one and only one point. It has one attribute.

4.2.1.1.10.2 position

The attribute *position* is derived from **DirectPosition** for the geometry primitive **GM_Point**. To assure alignment of tracking list values with the grid points in the bathymetry coverage grid, the reference system for the tracking list is the bathymetry coverage regular grid. This means that the *position* attribute corresponds to a grid point. For a uniform regular grid this is the row and column of the grid point position.

4.2.1.1.11 EX_GeographicExtent

4.2.1.1.11.1 EX_GeographicExtent semantics

The class **EX_GeographicExtent** is a metadata class from ISO 19115. It is a component of the metaclass **EX_Extent**. The use of **EX_GeographicExtent** is optional. When used it describes the spatial boundaries of the Tracking List elements within the bounds established by **CV_GridEnvelope** for the **BathymetryCoverage**. That is, the tracking list may carry information corresponding only to a portion of the spatial extent covered by the **BathymetryCoverage**. There is one attribute and one subtype.

4.2.1.1.11.2 extentTypeCode

The attribute *extentTypeCode* is a Boolean value. It is used to indicate whether the bounding polygon/box encompasses an area covered by the data or an area where data is not present. In S-102 it is set to 1.

4.2.1.1.12 EX_GeographicBoundingBox

4.2.1.1.12.1 EX_GeographicBoundingBox semantics

The class **EX_GeographicBoundingBox** is a metadata class from ISO 19115. It is a subtype of the abstract class **EX_GeographicExtent**. It defines a bounding box used to indicate the spatial boundaries of the tracking list elements within the bounds established by **CV_GridEnvelope** for the **BathymetryCoverage**. It has four attributes.

4.2.1.1.12.2 westBoundLongitude

The attribute *westBoundLongitude* is a coordinate value providing the west bound longitude for the bound.

4.2.1.1.12.3 eastBoundLongitude

The attribute *eastBoundLongitude* is a coordinate value providing the east bound longitude for the bound.

4.2.1.1.12.4 southBoundLatitude

The attribute *southBoundLatitude* is a coordinate value providing the south bound longitude for the bound.

4.2.1.1.12.5 northBoundLatitude

The attribute *northBoundLatitude* is a coordinate value providing the north bound longitude for the bound.

4.2.2 Tiling Scheme (Partitioning)

Tiling is a technique to decompose an area of interest into smaller more manageable chunks of data or partition. Each tile for an S-102 Bathymetry surface product is a complete **BathymetryCoverage** with depth and uncertainty values and optional tracking list together with metadata that is edge matched to adjacent tiles.

A Tiling scheme is a second higher level discrete grid coverage where the tiles are the value items of the discrete coverage. As such a tiling scheme requires a complete description as a coverage.

The tiling scheme does not have to be described with the data set, but it is necessary that the data set be able to index into the tiling scheme, and that the tiling scheme be well documented and able to be referenced.

Figure 4.5 shows the **S102_TilingScheme** structure. This structure is inherited from S-100. It is left general in order to accommodate different tiling schemes to be used by different data producers or national hydrographic offices.

The current S-102 assumes the Tiling Scheme is defined externally. However, a tile identifier is contained in the XML metadata as defined in **S102_Tile**. Future enhancements to this specification will include the capability of specifying a tiling scheme internally as defined by **S102_TilingScheme** and a sequence of **S102_Tiles** internally plus include the collection of datasets in a single package.

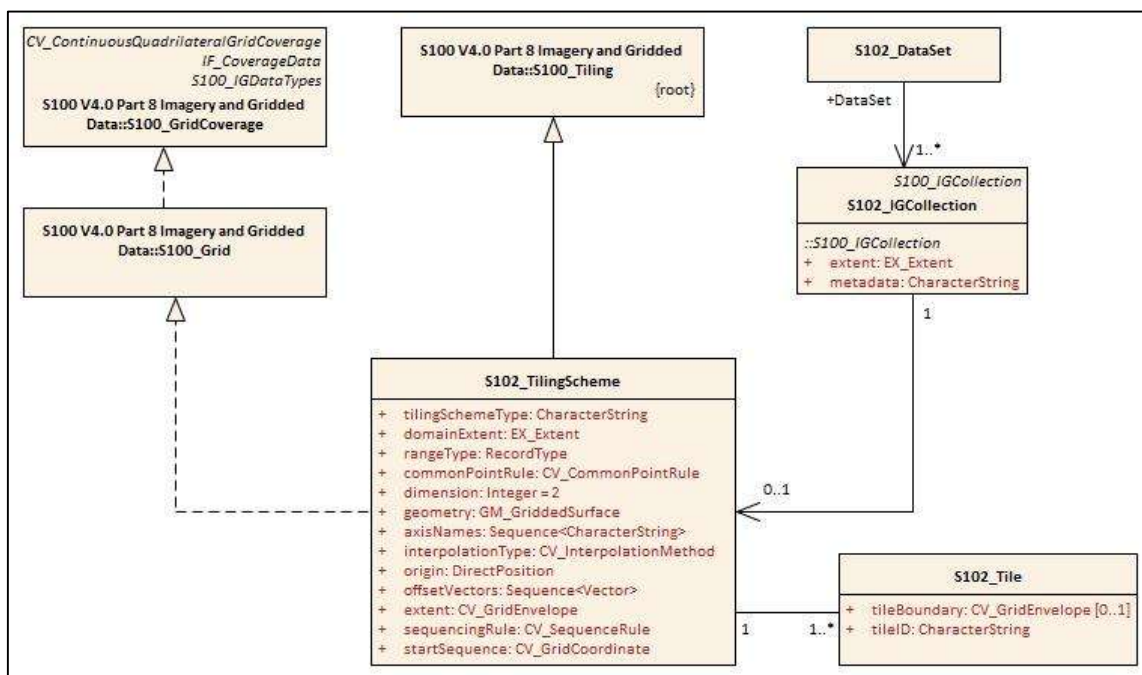

Figure 4.5 - S-102 Tiling Scheme

Table 4.1 below provides a description of each attribute of the S102_TilingScheme class attributes.

Table 4.1 - Tiling Scheme description

Role Name	Name	Description	Mult	Type	Remarks
Class	S102_TilingScheme	Container class for tiling scheme description	-	-	
attribute	tilingSchemeType	Description of the type of the tiling scheme	1	CharacterString	"uniform regular grid", or "Quad Tree" or other
attribute	domainExtent	Description of the extent of the tiling scheme	1	EX_Extent	
attribute	rangeType	Description of the range of the coverage	1	RecordType	The record value for each grid cell in a tiling scheme consists of a single entry corresponding to the tile
attribute	commonPointRule	Procedure to be used for evaluating the CV_Coverage at a position that falls on a boundary between tiles or within the boundaries of two or more overlapping tiles	1	CV_CommonPointRule	For tiles (not the data within a tile) the result is "all". That is, both tiles apply and are returned by a tiling scheme coverage function. The application will determine which to use
attribute	geometry	Geometry of the domain object	1	GM_GriddedSurface	
attribute	interpolationType	Identification of interpolation method	1	CV_InterpolationMethod	Not applicable. Tiles cannot be interpolated
attribute	dimension	Dimensionality of the grid	1	Integer	Default = 2 No other value is allowed
attribute	axisNames	Names of the grid axis	1	CharacterString	The grid axis names are by default "Longitude" and "Latitude" but may be different if, for example, the grid is at a different orientation
attribute	origin	Position that locates the origin of the rectified grid in the coordinate reference system	1	DirectPosition	
attribute	offsetVectors	A 2-dimensional vector quantity that determine the grid spacing in each direction	1	Sequence <Vector>	
attribute	extent	Description of the extent of the tiling scheme	1	CV_GridEnvelope	
attribute	sequencingRule	Describe how the grid points are ordered for association to the elements of the sequence values.	1	CV_SequenceRule	The default value is "Linear" which is used for a <u>uniform regular grid tile coverage</u> . No other value is allowed
attribute	startSequence	The grid point to be associated with the first record in the values sequence	1	CV_GridCoordinate	The default value is the lower left corner of the grid

4.3 Feature Catalogue

4.3.1 Introduction

The S-102 Feature Catalogue describes the feature types, information types, attributes, attribute values, associations and roles which may be used in the product.

The S-102 Feature Catalogue is available in an XML document which conforms to the S-100 XML Feature Catalogue Schema and can be downloaded from the IHO website.

Note, for Imagery and Gridded Data, coverage is a type of feature so a product specification may not contain a “catalogue” with the exception of the environmental parameter the dataset models. Therefore, much of this clause may be irrelevant.

4.3.2 Feature Types

S-102 is a coverage feature product. There are two coverages defined in this specification: **BathymetryCoverage** and **TrackingListCoverage**. **BathymetryCoverage** implements **S102_DepthCoverage** and includes **S102_BathymetryValues**. The second coverage, **TrackingListCoverage** implements **S102_CorrectionCoverage**, and includes **S102_TrackingListValues**. The **S102_CorrectionCoverage** is a discrete point set coverage.

4.3.2.1 Geographic

Geographic (geo) feature types form the principle content of the dataset and are fully defined by their associated attributes and information types. In S-102, **BathymetryCoverage** has been registered as a geographic feature type.

4.3.2.2 Meta

The only meta feature within an S-102 dataset is the tracking list. The tracking list is a simple list of nodes that have been modified to account for hydrographer over-rides of the basic surface definition (for example as originally computed by an algorithmic method). Each record within the list contains the original depth value (referenced to the associated node within the surface) and information about the override that occurred. The tracking list dataset and corresponding information contained in the metadata exist to provide an audit trail record of changes made to the data by manual intervention.

4.3.3 Feature Relationship

A feature relationship links instances of one feature type with instances of the same or a different feature type. There are three common types of feature relationship: Association, Aggregation and Composition.

S-102 uses only one type of feature relationship: Association.

4.3.3.1 Association

An association is used to describe a relationship between two feature types that defines relationships between their instances.

Example: A **S102_IG_Collection** may contain a (0 or 1) **S102_TilingScheme**.

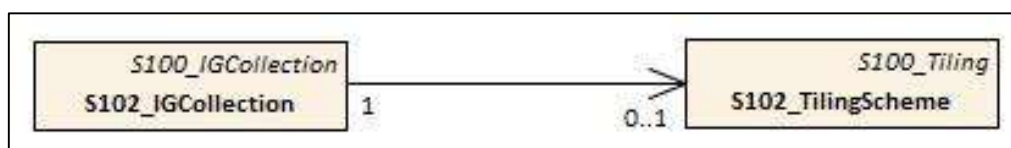

Figure 4.6 - Feature Association

4.3.4 Attributes

4.3.4.1 Simple Attributes

Table 4.2 - S-102 Simple Attributes

Type	Definition
Enumeration	A fixed list of valid identifiers of named literal values
Boolean	A value representing binary logic. The value can be either <i>True</i> or <i>False</i> . The default state for Boolean type attributes (i.e. where the attribute is not populated for the feature) is <i>False</i>
Real	A signed Real (floating point) number consisting of a mantissa and an exponent
Integer	A signed integer number. The representation of an integer is encapsulation and usage dependent
CharacterString	An arbitrary-length sequence of characters including accents and special characters from a repertoire of one of the adopted character sets
Date and Time	A DateTime is a combination of a date and a time type. Character encoding of a DateTime must follow ISO 8601:2004 EXAMPLE 19850412T101530

In S-102, *depth* and *uncertainty* have been registered as simple attributes, type <real>.

4.3.4.2 Complex Attributes

In S-102 there are currently no complex attributes defined.

4.4 Dataset Types

4.4.1 Introduction

Bathymetric Surface datasets are represented as a discrete array of points contained in a regular grid. The general structure for a regular grid is defined in IHO S-100 Part 8.

4.4.2 Regular Grid

4.4.2.1 S-102 Coverages

The major components of the Bathymetric Surface product are the **BathymetryCoverage** and the **TrackingListCoverage**. The **BathymetryCoverage** contains depth and, optionally, uncertainty. The general structure of each is defined in IHO S-100 Part 8 as a georectified grid. Spatial metadata parameters are defined in **S102_StructureMetadataBlock**. Furthermore, the two values are co-located within the **BathymetryCoverage**. Each layer contains a two-dimensional matrix organized in row major order, and starting from the south-western most data point, where each value is defined to be at an exactly specified geographic point (or grid node).

The units of the depth values are in metres, and the sign convention is for z to be positive for values above the vertical datum. The reference vertical datum for the surface is one of the mandatory Metadata items. This sign convention follows directly from the right-hand coordinate system definition to which the standard adheres.

The unknown state for depth is defined to be 1,000,000.0 (1.0e6).

The uncertainty values are expressed as positive quantities at a node. As detailed in clause 12.2 the uncertainty grid supports multiple definitions of vertical uncertainty. This allows grids to span the expected range of data products from raw, full resolution grid to final compiled product. For example, a

grid at the stage of final survey data processing should contain uncertainty information germane to the survey data itself and intended to be used for information compilation. A recipient of an S-102 file can refer to the uncertainty definition in the Metadata to gain an understanding of how the uncertainty was computed.

The undetermined state for uncertainty is defined to be 1,000,000.0 (1.0e6).

4.4.2.2 Extensions

The Bathymetric Surface Product Specification is extensible. This includes both extensions to the content model and to the encodings supporting the content model. Extensions are optional coverages and not required for a file to be qualified nor do they invalidate a compliant product. Additional layers of information not related to the bathymetric scope of this product specification should be defined in separate S.100 and S.10x compliant layers.

4.5 Multiple Datasets

In order to facilitate the efficient processing of S-102 data, the geographic coverage of a given **maximum display Scale** may be split into multiple datasets.

The discovery or exchange metadata of a dataset must list all extents or the **Data Coverage** features contained within that dataset and their assigned scale attributions.

4.6 Dataset Rules

Each S-102 dataset must only have a single extent as it is a coverage feature.

There should be no overlapping data of the same **maximum display scale**, except at the agreed adjoining limits. Where it is difficult to achieve a perfect join, a buffer to be agreed upon by the producing agencies may be used.

In order to facilitate the efficient processing of S-102 data the geographic coverage of a given **maximum display scale** may be split into multiple datasets.

4.7 Geometry

S-102 regular gridded coverages are an implementation of S-100 Grid Coverage (Part 8 - Imagery and Gridded Data) and is composed of a series of discrete points. S-102 tracking list is a series of S100 Points (Part 8 - Point) in which the xy of each point is a reference to a location within the gridded coverage where an override occurred.

5 Coordinate Reference Systems (CRS)

5.1 Introduction

The geo-referencing for an S-102 Bathymetric Surface product shall be node-based, referenced from the southwestern-most node in a grid. Each sample in a grid represents the value in the grid at a point location at the coordinate specified, rather than an estimate over any area with respect to the coordinate. The reference position included in the metadata shall be given in the coordinates used for the grid and shall contain sufficient digits of precision to locate the grid with accuracy no worse than a decimetre on the surface of the ellipsoid of rotation of the chosen horizontal datum.

The Coordinate Reference System information contained in table 5.1 is defined in the manner specified in S-100 Part 6. Note the vertical datum is defined through a second association role to a vertical reference system.

5.2 Spatial Reference System

All coverages in the Bathymetric Surface Product Specification are geo-rectified, simple uniform regular grids as defined in IHO S-100 Part 8.

The grid data in a S-102 Bathymetric Surface coverage (either depth or uncertainty, and any other surfaces that may be added) shall be organized as a uniform regular grid in row-major order from west to east, and south to north. Thus, the first sample of the grid is the node at the southwest corner of the grid with location as specified by the geo-referencing parameters, the second is one grid resolution unit to the east of that position and at the same northing or latitude, and the third is two grid resolution units to the east and at the same northing or latitude. For C columns in the grid, the (C+1)th sample in the grid is located one grid resolution unit to the north, but on the same easting, or longitude, as the first sample in the grid.

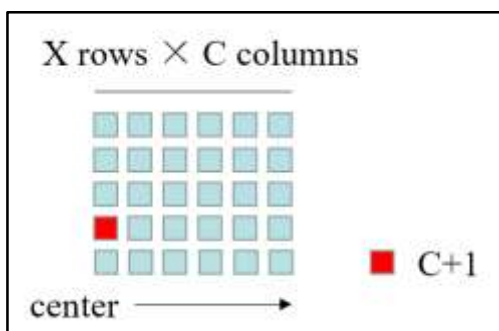

Figure 5.1 - S-102 Grid Node location

5.3 Horizontal Coordinate Reference System

Table 5.1 - S-102 Coordinate Reference Systems (EPSG Codes)

EPSG Code	Coordinate Reference System
4326	WGS84
32601 – 32660	WGS 84 / UTM Zone 1N to Zone 60N
32701 - 32760	WGS 84 / UTM Zone 1S to Zone 60S
5041	WGS 84 / UPS North (E,N)
5042	WGS 84 / UPS South (E,N)
The full reference to EPSG can be found at www.epsg-registry.org .	

Horizontal Coordinate Reference System:	EPSG (see Table 5.1)
Projection:	NONE/UTM/UPS
Temporal reference system:	Gregorian Calendar
Coordinate reference system registry:	EPSG Geodetic Parameter Registry
Date type (according to ISO 19115):	002 - publication
Responsible party:	International Organisation of Oil and Gas Producers (OGP)
URL:	http://www.ogp.org.uk/

5.4 Vertical Coordinate Reference System

All valid S-102 datasets shall be represented with a right-handed Cartesian coordinate system. This system shall have the x-axis oriented towards positive eastings (for projected grids), or east (for geographic grids), and y-axis oriented towards positive northings (for projected grids), or north (for geographic grids).

geographic grids). These definitions imply that the z-axis for the sounding data is positive away from the center of mass of the earth (that is, is positive up), rather than the usual hydrographic convention of positive down (that is, deeper depths are larger numbers and negative depths are above datum). User-level code is free to make this reflection if required but must write the data using the positive-up convention. The uncertainty component shall have the same coordinate system as the depth component, with the exception that the z-axis is unipolar, and therefore the concept of direction of positive increase is irrelevant.

5.5 Temporal Reference System

The temporal reference system is the Gregorian calendar for date and UTC for time. Time is measured by reference to Calendar dates and Clock time in accordance with ISO 8601:2004, Temporal Schema, clause 5.4.4. A date-time variable will have the following 16-character format: *yyyymmddThhmmssZ*.

6 Data Quality

Data quality allows users and user systems to assess fitness for use of the provided data. Data quality measures and the associated evaluation are reported as metadata of a data product. This metadata improves interoperability with other data products and provides usage by user groups that the data product was not originally intended for. The secondary users can make assessments of the data product usefulness in their application based on the reported data quality measures.

6.1 Completeness

6.1.1 Commission

The S-102 bathymetric grid has a high-level of completeness regarding commission, due to the fact that the issuing hydrographic office has deemed the grid to contain all the necessary data and/or considered all contributing factors required to make a navigationally valid product. These factors are recorded in the metadata for the file.

6.1.2 Omission

The S-102 bathymetric grid has a high level of completeness in regards to omission, due to the fact that the issuing hydrographic office will have noted any major discrepancies or negative quality factors in the applicable fields of the metadata for the file.

6.2 Logical Consistency

6.2.1 Conceptual Consistency

The conceptual consistency of S-102 grids is maintained through this and related specifications which are conceptually consistent with the accepted standards.

6.2.2 Domain Consistency

The domain consistency of S-102 grids is maintained through the definition of their primary purpose, which is safety of navigation. The data contained can also be used derivatively for other scientific/fields domains (secondary purposes). All processes used in primary purpose generation is geared solely towards the satisfaction of safety of navigation concerns.

6.2.3 Format Consistency

The formatting consistency of S-102 grids is maintained due to the overriding encoding (HDF5) defined in the S-100 specification and the other IHO standards on which the data is based.

6.3 Positional Accuracy

6.3.1 Accuracy of a Time Measurement

Temporal aspects of bathymetric grids are confined to elements of the vertical control processes. These aspects are addressed during the formulation and application of vertical control processes applied by the various hydrographic offices. Details of these processes will be included in the Lineage portion of the metadata defined in section 12 of this Product Specification.

6.3.2 Gridded Data Positional Accuracy

Gridded positional accuracy is defined by the precision of the positional reference used to specify its location within its spatial projection. These positional references are contained within the spatial metadata of the S-102 grid. Nodes within a bathymetric grid have an absolute position with no horizontal error with vertical values that are calculated for that position by the processes and procedures used by each hydrographic office during the creation of the S-102 grid. Appropriate selection of both the origin reference points and positional resolution are important and are another factor in gridded positional accuracy.

6.3.3 Relative Internal Positional Accuracy

The internal positional accuracy is defined as the precision of the location of each node within the S-102 grid. The position of each node within the grid is referenced by a row and column combination. The metadata for the S-102 defines a gridded resolution along both the X and Y axis of the grid. This absolute position of a node within the spatial projection of the grid is calculated using the row/column and the X/Y resolution. In this case, the accuracy is controlled by the precision used in defining these resolutions.

6.4 Temporal Accuracy

6.4.1 Temporal Consistency

Temporal aspects of bathymetric grids are confined to elements of the vertical control processes. These aspects are addressed during the formulation and application of vertical control processes applied by the various hydrographic offices. Details of these processes will be included in the Lineage portion of the metadata defined in section 12 of this Product Specification.

6.4.2 Temporal Validity

Temporal aspects of bathymetric grids are confined to elements of the vertical control processes. These aspects are addressed during the formulation and application of vertical control processes applied by the various hydrographic offices. Details of these processes will be included in the Lineage portion of the metadata defined in section 12 of this Product Specification.

6.5 Thematic Accuracy

6.5.1 Thematic Classification Correctness

For S-102 bathymetric grids there are two classifications of data values, which are land and water. There are two considerations for accessing classification correctness when using the grid. The first is that values given in the depth layer of the S-102 grid are based on the associated hydrographic offices chosen vertical datum. Should another value in relation to a different vertical datum be required, a series of correctors would need to be applied. Secondly, when considering the data values, the value stored in the corresponding uncertainty node must be considered. This uncertainty value is a +/- value and when assessing the classification correctness must be applied. The new value(s) generated when applied may cause a change in the classification.

6.5.2 Non-Quantitative Attribute Accuracy

Thematic accuracy of S-102 bathymetric data is wholly quantitative.

6.5.3 Quantitative Attribute Accuracy

As defined in IHO S-100 Part 4c the data quality for the depth coverage is also defined as a co-located coverage, uncertainty. Uncertainty is defined as the vertical uncertainty at each node location. The uncertainty coverage supports multiple definitions of vertical uncertainty.

See Table 12.4 - Code describing how uncertainty was determined.

7 Data Capture and Classification

The Data Classification and Encoding Guide (DCEG) describes how data describing the real world should be captured using the types defined in the S-102 Feature Catalogue. This Guide is located at Annex A.

There are a number of sounding techniques, including SONAR and LIDAR that are used to capture bathymetric data. It is permitted, but not required, to include data acquisition information in the metadata of an S-102 Bathymetric Surface product. The metadata class S102_AcquisitionMetadata has been defined, but the information elements to populate this metadata class should be identified in a national profile of S-102.

8 Data Maintenance

8.1 Maintenance and Update Frequency

Datasets are maintained by replacement on a tile or dataset basis. That is, the entire data product or tile within a data set including its coverages (depth, uncertainty, and tracking list point set coverage) and the associated metadata are replaced as a unit. This is unlike vector data that may be updated incrementally. However, coverage data must be considered as a unit at least at the tile level. This is because processing is done on the entire tile to produce the data product. Any replacement tile will include its own tracking list (when a tracking list is used) to deliberately bias the information for safety of navigation. Also, each replacement tile or data set must have its own digital signature.

8.2 Data Source

Data producers must use applicable sources to maintain and update data and provide a brief description of the sources that were used to produce the dataset.

8.3 Production Process

Data Producers should follow their established production processes for maintaining and updating datasets.

9 Portrayal

9.1 Introduction

This clause describes the display of bathymetric surface data to support the safe navigation of marine vessels. The following portrayal options are intended to enhance mariner decision making while taking into consideration the need to minimize cluttering of the navigation display. S-102 portrayal options:

- Display of gridded bathymetry
- Colouring options to support safe navigation.

9.2 Generation and Display of Gridded Bathymetry

Most modern hydrographic surveys are conducted using high-resolution multibeam sonar systems. While these systems provide a highly detailed depiction of the seafloor, the storage and processing requirements (that is, data management) can be challenging. A typical hydrographic survey can collect upwards of 10 billion depth estimates over a thirty-day collection period.

Utilization of a gridded data structure eases the data management concerns of the hydrographer, providing the ability to safely decimate the total sum of collected depth estimates into a manageable quantity of representative nodal depths for processing and production. All gridded datasets should be exposed to rigid Quality Assurance/Control procedures to ensure the final gridded dataset accurately represents the real-world environment. Once a dataset passes an established Quality Assurance/Control process, modern chart production software is used to extract candidate nodal depths from the grid for consideration as final charted soundings.

Annex G provides a listing of S-102 accepted gridding methods.

Annex I provides an example gridding process, discussing the difference between full resolution source bathymetry, product scale grid, and charted sounding.

9.2.1 Charted Soundings/Contours vs. Gridded Bathymetry

Depth information on a nautical chart is generally displayed as depth soundings, depth contours, and depth areas. Depth contours are used to connect soundings of equal elevation referenced to a specific sounding datum.

The introduction of a fourth depth source, S-102 gridded data, enhances navigation decision making by providing the mariner with the ability to visualize and colour a pseudo three-dimensional, sun-illuminated, contiguous image of the seafloor. While this is a benefit, producers should understand that the selection of an improper grid resolution (that is too coarse, or too fine) may complicate the overall navigation solution when displayed with traditional depth information. Table 11.1 provides informative grid resolutions for each charting scale to aid in the selection of a final grid resolution. It should be noted that Table 11.1 does not contain mandatory resolutions. Final identification of the “appropriate” resolution is left to the data producer.

9.2.2 Use of Sun-Illumination

S-102 data can be visualized as a sun-illuminated or static (flat) dataset. The depiction of sun-illumination requires the entry of a sun azimuth and corresponding elevation. Informative values for sun azimuth angle and elevation have been provided in Table 9.1. Figure 9.1 shows the difference between a sun-illuminated and static (flat) surface.

Table 9.1 - Sun Azimuth and Elevation Values

Attribute	Value in Degrees	
	Sun-Illuminated	Flat Surface
Sun Azimuth Angle	315 Degrees	0.0 Degrees
Sun Elevation	45 Degrees	0.0 Degrees

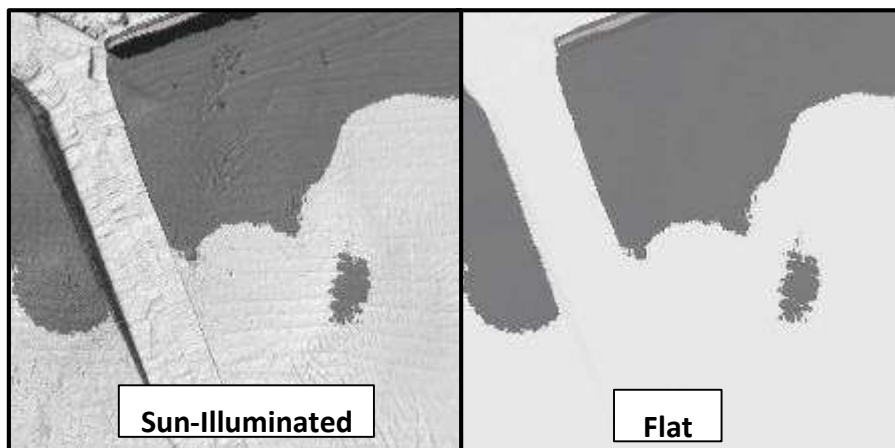

Figure 9.1 - Sun Illuminated and Static (Flat) Shading

9.2.3 Transparency

S-102 dataset transparency display settings are identified in Table 9.2. The level of opaqueness is represented by the value alpha. A value of 1 represents zero transparency. A value of 0 represents 100% transparency.

Table 9.2 - Transparency values for S-102 Dataset

ENC Display Setting	Alpha
ENC Day	1.0
ENC Dusk	0.4
ENC Night	0.2

9.3 Generation and Display of Navigation Zones

The addition of S-102 dataset enhances the mariner’s ability to render and display, using colours, higher resolution depth zoning directly from the grid.

At time of ingest a display system will delineate and display navigational depth zones by comparing the depth layer of the S-102 dataset to the mariner defined vessel draft or default safety contour. Depth zone naming and colouring (Tables 9.3 - 9.5, and Figure 9.2) may follow IHO S-52, Edition 6.1(.1). *Note: colour parameters listed in Tables 9.3 – 9.5 are specified in CIE x, y, L co-ordinates.*

Table 9.3 - Depth Zone and Colour Token Information for Day

Depth Zone Name	Description	Colour	X	Y	L
Deep Water (DEPDW):	Deeper than the deep contour	White	.28	.31	80
Medium-deep water (DEPMD):	Depths between the deep contour and the safety contour	Blue	.26	.29	65
Medium-shallow (DEPMS):	Depths between the safety contour and the shallow contour	Blue	.23	.25	55
Very Shallow Water (DEPVS):	Depths between the shallow contour and the zero metre contour	Blue	.21	.22	45
Drying Foreshore (DEPIT):	Intertidal area	YellowGreen	.26	.36	35

Table 9.4 – Depth Zone and Colour Token Information for Dusk

Depth Zone Name	Description	Colour	X	Y	L
Deep Water (DEPDW):	Deeper than the safety contour	White	.28	.31	00
Shallow Water (DEPVS):	Shallower than the safety contour	Blue	.21	.22	5.0
Intertidal (DEPIT):	Area exposed at low water	YellowGreen	.26	.36	6.0

Table 9.5 – Depth Zone and Colour Token Information for Night

Depth Zone Name	Description	Colour	X	Y	L
Deep Water (DEPDW):	Deeper than the safety contour	White	.28	.31	00
Shallow Water (DEPVS):	Shallower than the safety contour	Blue	.21	.22	0.8
Intertidal (DEPIT):	Area exposed at low water	YellowGreen	.26	.36	1.2

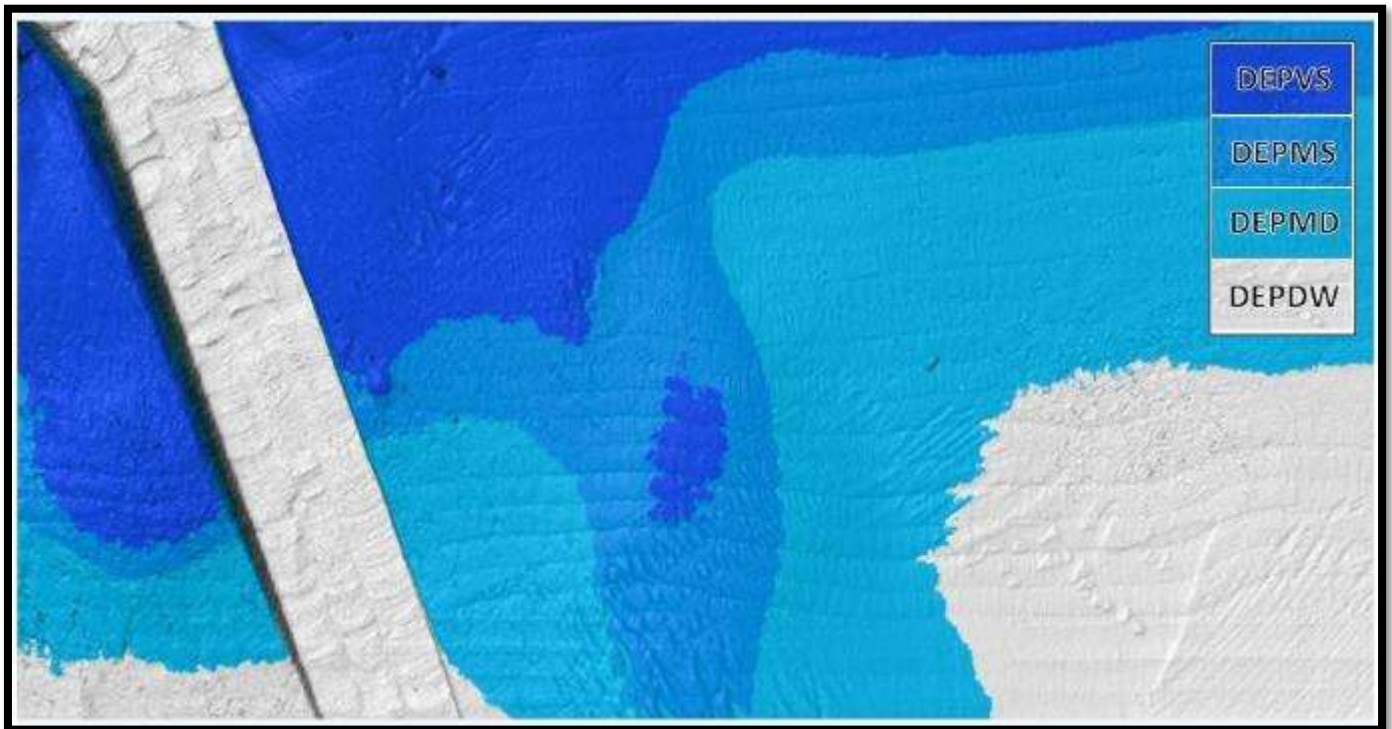
**Figure 9.2 - S-52, Edition 6.1(.1) Depth Zone Colouring for Day**

10 Data Product Format (Encoding)

10.1 Introduction

The S-102 data set must be encoded using the Hierarchical Data Format standard, Version 5 (HDF5).

Format Name: HDF5

Version: 1.8

Character Set: UTF-8

Specification: <https://www.hdf5group.org>

The key idea behind the S-102 product structure is that each coverage is a feature. Each of these features is co-located with the others. Therefore, they share the same spatial metadata and each is required to correctly interpret the others.

For the use of HDF5, the following key concepts (S-100 Part 10c, clause 10c-5.1) are important:

- *File* - a contiguous string of bytes in a computer store (memory, disk, etc.), and the bytes represent zero or more objects of the model;
- *Group* - a collection of objects (including groups);
- *Dataset* - a multidimensional array of data elements with attributes and other metadata;
- *Dataspace* - a description of the dimensions of a multidimensional array;
- *Datatype* - a description of a specific class of data element including its storage layout as a pattern of bits;
- *Attribute* - a named data value associated with a group, dataset, or named datatype;
- *Property List* - a collection of parameters (some permanent and some transient).

In addition, datasets may be a compound (a single record consisting of an array of simple value types) and have multiple dimensions.

10.2 Product Structure

The structure of the data product follows the form given in S-100 Part 10C – HDF5 Data Model and File Format. The general structure, which was designed for several S-100 products is given in Figure 10.1.

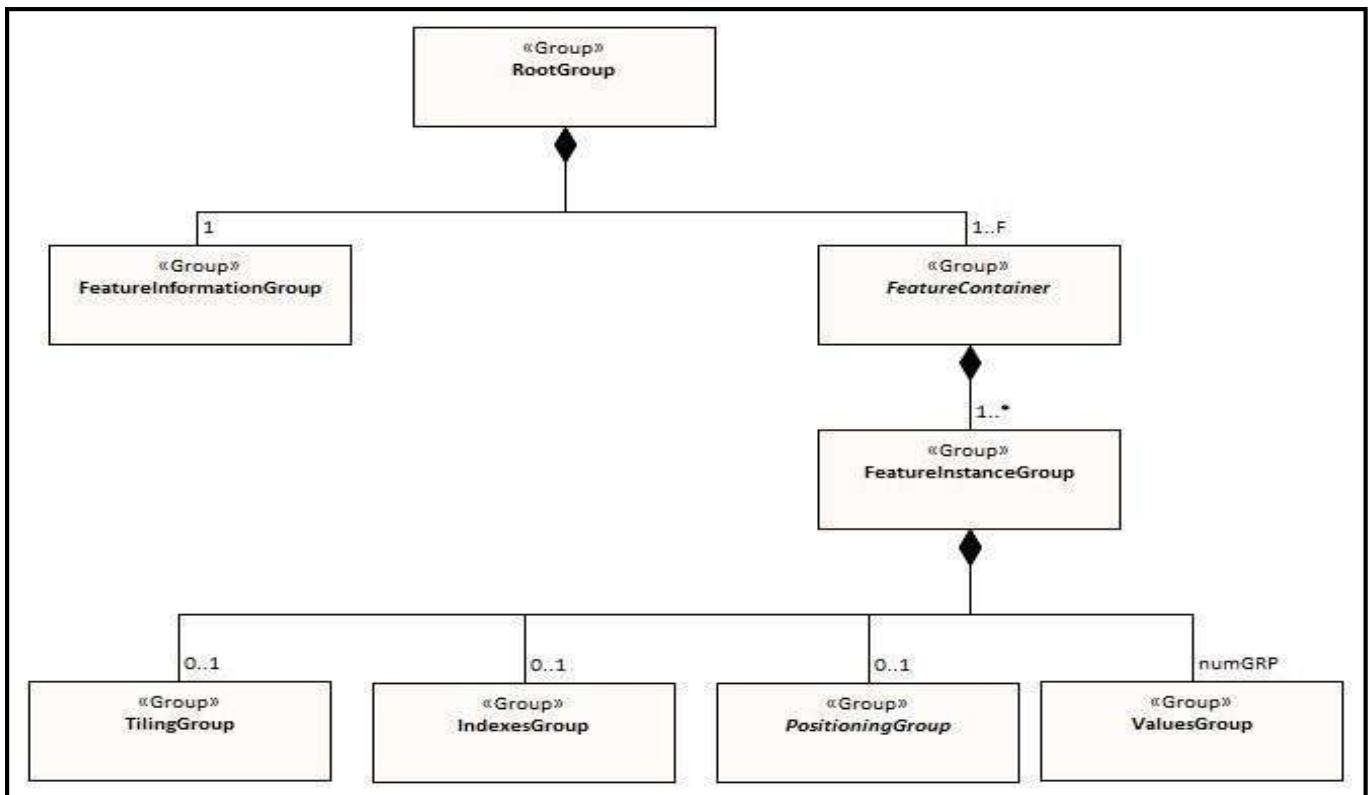

Figure 10.1 - Outline of the generic data file structure

Figure 10.1 shows the four levels defined within the HDF encoding. Below is a further definition of these levels.

Level 1: At the top level lies the Root Group, and it contains the Root Metadata and two subsidiary groups. The Root Metadata applies to all S-100 type products.

Level 2: The next Level contains the Feature Information Group and the Feature Container Group. The Feature Information Group contains the feature names (**BathymetryCoverage**, **TrackingListCoverage**) and the feature attribute codes. The Feature Container Group contains the Feature Metadata and one or more Feature Instance Groups.

Level 3: This contains one or more Feature Instances. A feature instance is a bathymetric gridded data for a single region, or a tracking list of nodal overrides.

Level 4: This contains the actual data for each feature.

In Table 10.1 below, levels refer to HDF5 structuring (see S-100 Part 10c, Figure 10c-9). Naming in each box below the header line is as follows: Generic name; S-100 or S-102 name, or [] if none; and (*HDF5 type*) group, attribute or attribute list, or dataset.

Table 10.1 - Overview of S-102 Data Product

LEVEL 1 CONTENT	LEVEL 2 CONTENT	LEVEL 3 CONTENT	LEVEL 4 CONTENT
General Metadata (metadata) (<i>h5_attribute</i>)			
Feature Codes Group_F (<i>h5_group</i>)	Feature Name BathymetryCoverage (<i>h5_dataset</i>)		
	Feature Name TrackingListCoverage (<i>h5_dataset</i>)		
	Feature Codes featureCode (<i>h5_dataset</i>)		
Feature Type BathymetryCoverage (<i>h5_group</i>)	Type Metadata (metadata) (<i>h5_attribute</i>)		
	X and Y Axis Names axisNames (<i>h5_dataset</i>)		
	Feature Instance BathymetryCoverage_01 (<i>h5_group</i>)	Instance Metadata (metadata) (<i>h5_attribute</i>)	
		First data group Group_001 (<i>h5_group</i>)	Bathymetric Data Array values (<i>h5_dataset</i>)
	X and Y Axis Names axisNames (<i>h5_dataset</i>)		
	...		
Feature Type TrackingListCoverage	Type Metadata (metadata) (<i>h5_attribute</i>)		
	Feature Instance TrackingListCoverage_01 (<i>h5_group</i>)	Instance Metadata (metadata) (<i>h5_attribute</i>)	

LEVEL 1 CONTENT	LEVEL 2 CONTENT	LEVEL 3 CONTENT	LEVEL 4 CONTENT
		First data group Group_001 (h5_group)	Tracking_List values (h5_dataset)

The following sections explain entries in Table 10.1 in greater detail.

10.2.1 Feature Codes (Group_F)

This group specifies the S-100 features to which the data applies, and consists of three components:

featureName – a dataset with the name(s) of the S-100 feature(s) contained in the data product. For S-102, the dataset has two elements. These elements are **BathymetryCoverage** and **TrackingListCoverage**.

BathymetryCoverage – One of the features described in the featureName. This dataset contains the standard definition of the feature class (Table 10.2 shows an example).

TrackingListCoverage – One of the features described in the featureName. This dataset contains the standard definition of the feature class.

Table 10.2 - Sample contents of the two-dimensional BathymetryCoverage array

Name	Explanation	S-100 Attribute 1	S-100 Attribute 2
code	Camel Case Name	depth	uncertainty
name	plain text	depth	uncertainty
uom.name	Units of Measurement)	metres	metres
fillValue	Denotes missing data	1000000	1000000
datatype	HDF5 datatype	H5T_FLOAT	H5T_FLOAT
lower	Lower bound on attribute	-12000	-12000
upper	Upper bound on attribute	12000	12000
closure	Open or Closed data interval. See S100_IntervalType in Part 1.	closedInterval	closedInterval

10.2.2 Values Groups (Group_nnn)

These groups each contain the compound data arrays containing bathymetric gridded data or tracking list data. These components are explained below.

For bathymetric gridded data, the dataset includes a two-dimensional array containing both the depth and uncertainty data. These dimensions are defined by *numPointsLongitudinal* and *numPointsLatitudinal*. By knowing the grid origin and the grid spacing, the position of every point in the grid can be computed by simple formulae.

For tracking list data, the dataset includes a single dimension array containing the position (X, Y) of each override, defined as row/col of the bathymetric grid, the original value, the type of override and the index into the metadata that defines the override. The number of overrides in the array is defined by the originator and this dataset could be empty if no overrides were required.

10.2.3 Data Arrays

Within the **BathymetryCoverage**, the depth and uncertainty values (depth and uncertainty) are stored in two dimensional arrays named *values*, with a prescribed number of columns (*numCOL*) and rows

(*numROW*). This grid is defined as a regular grid (*dataCodingFormat* = 2), therefore; the depth and uncertainty values will be for each discrete point in the grid. The data array *values* is two-dimensional.

Within the **TrackingListCoverage**, entries are stored in a single dimensional array named *values*. The number of rows in this array is dynamic as entries into this dataset are optional as not all data sources require modifications to the **BathymetryCoverage**. This grid is defined as a point set (*dataCodingFormat* = 1), if it exists.

10.2.4 Summary of Generalized Dimensions

To summarize, there are data Groups contains one of two types of feature datasets. The first contains the depth and uncertainty data, which are stored in two-dimensional arrays of size *numROW* by *numCOL*. The second is a single dimension array containing information on overrides that were performed on the data in the dataset.

10.2.5 Mandatory Naming Conventions

The following group and attribute names are mandatory in S-100: Group_F, featureCode, and (for S-102) **BathymetryCoverage**, **TrackingListCoverage**, axisNames, **BathymetryCoverage_01**, **TrackingListCoverage_01**, and Group_nnn. Attribute names shown in Annex G are also mandatory.

10.3 Sample HDF5 Encoding

The product structure has been designed for compatibility with the HDF5 capabilities. The HDF5 encoding of the data set is discussed in Annex B.

11 Data Product Delivery

11.1 Introduction

This clause describes how S-102 data will be delivered from the charting authority to the mariner.

Units of Delivery:	Exchange Set
Transfer Size:	See clause 11.2.2.
Medium Name:	Digital Data Delivery
Other Delivery Information:	<p>Each dataset must be contained in a physically separate, uniquely identified file on the transfer medium.</p> <p>Each exchange set has a single exchange catalogue which contains the discovery metadata for each dataset.</p> <p>An exchange set is encapsulated into a form suitable for transmission by a mapping called an encoding. An encoding translates each of the elements of the exchange set into a logical form suitable for writing to media and for transmission online. An encoding may also define other elements in addition to the exchange set contents (This is media identification, data extents etc....) and may define commercial constructs such as encryption and compression methods.</p> <p>If the data is transformed in S-102 it must not be changed.</p> <p>This Product Specification defines the encoding which must be used as a default for transmission of data between parties.</p> <p>The encoding encapsulates exchange set elements as follows:</p>

Mandatory Elements

- S-102 datasets – HDF encoding
- Exchange Catalogue – the XML encoded representation of exchange set catalogue features [discovery metadata].

Optional Elements

- S-102 Feature Catalogue – If it is necessary to deliver the latest Feature Catalogue to the end user it may be done using the S-102 exchange set mechanism for datasets
- S-102 Portrayal Catalogue - If it is necessary to deliver the latest Portrayal Catalogue to the end user it may be done using the S-102 exchange set mechanism for datasets.

11.2 Dataset

11.2.1 Dataset Management

Three types of dataset files may be produced and contained within an exchange set:

- New dataset: Initial.
- New edition of a dataset: Includes new information. New editions must cover the same area as its predecessor.
- Cancellation: The dataset is cancelled and no longer available to be displayed or used.

11.2.2 Dataset Size

S-102 delivery will take place in one of two forms: 1) network transfer to platform (that is, internet download), or 2) physical media transfer (that is, removable media). An example scenario for each method has been provided below:

Note: *The use of 10 MB and 256 MB in this and other sections should be treated as informative information only. Additionally, any computed values associated with either file size limit should be treated as approximate answers. Final selection of an appropriate file size limit or grid resolution is left to the discretion of the data producer.*

Network Transfer: To minimize overall file size, the HO produces a 10 MB file for wireless transmission to marine vessels. In uncompressed form, this file would contain roughly 600 nodes by 600 nodes.

Physical Transfer: The HO produces a 256 MB file which can be personally delivered to a ship in port. In uncompressed form, this file would contain roughly 5700 nodes by 5700 nodes.

Table 11.1: Informative Grid Resolutions and Tile Size at Chart Scale, provides general information to aid in the compilation of S-102 data for specific charting scales.

Annex F: S-102 Dataset Size and Production, discusses in greater detail the physical size components of an S-102 file.

11.2.2.1 S-102 Grid Resolution and Tiling

Table 11.1 - Informative Grid Resolution and Resulting Tile Size at Chart Scale

Scale	Informative Grid Resolution	Resulting Tile Size @ 10 MB	Resulting Tile Size @ 256 MB
NULL (only allowed on minimum display scale where the maximum display scale = 10,000,000)		Approximate Linear Distance in Nautical Miles (M) for a 600 X 600 node grid	Approximate Linear Distance in Nautical Miles (M) for a 5700 X 5700 node grid
1:10,000,000	900 metres	291 X 291	2770 X 2770

Scale	Informative Grid Resolution	Resulting Tile Size @ 10 MB	Resulting Tile Size @ 256 MB
1:3,500,000	900 metres	291 X 291	2770 X 2770
1:1,500,000	450 metres	145 X 145	1385 X 1385
1:700,000	210 metres	68 X 68	646 X 646
1:350,000	105 metres	34 X 34	323 X 323
1:180,000	54 metres	17.5 X 17.5	166 X 166
1:90,000	27 metres	8.7 X 8.7	83 X 83
1:45,000	13 metres	4.2 X 4.2	40 X 40
1:22,000	6 metres	1.9 X 1.9	18.5 X 18.5
1:12,000	3 metres	1.0 X 1.0	9.0 X 9.0
1:8,000	2 metres	0.6 X 0.6	6.0 X 6.0
1:4,000	1 metres	0.3 X 0.3	3.0 X 3.0
1:3,000	1 metres	0.3 X 0.3	3.0 X 3.0
1:2,000	1 metres	0.3 X 0.3	3.0 X 3.0
1:1,000	1 metres	0.3 X 0.3	3.0 X 3.0

11.2.3 Dataset file naming

Dataset naming must follow a standard pattern to give implementers greater predictability of incoming datasets. S-102 dataset naming conventions must follow these rules.

102PPPP000000000000.H5

- 102 - the first 3 characters identify the dataset as an S-102 dataset (mandatory).
- PPPP - the fourth to seventh characters is the producer code according to the IHO Geospatial Information Registry, Producer Code Register (mandatory for S-102).
- 00000000000000 - the eighth to the maximum nineteenth characters are optional and may be used in any way by the producer to provide the unique file name. The following characters are allowed in the dataset name: A to Z, 0 to 9 and the special character _ (underscore).
- H5 - denotes and HDF5 file.

11.3 Exchange Catalogue

The exchange catalogue acts as the table of contents for the exchange set. The catalogue file of the exchange set must be named CATATLOG.102. No other file in the exchange set may be named CATALOG.102. The contents of the exchange catalogue are described in clause 12.

11.4 Data integrity and encryption

S-100 Part 15 defines the algorithms for compressing, encrypting and digitally signing datasets based on the S-100 Data Model. The individual Product Specifications provide details about which of the elements are being used and on which files in the dataset.

11.4.1 Use of Compression

The data producer decides if compression will be used on the S-102 product files (HDF5). It is expected that a hydrographic office will make a policy decision and that all the S-102 datasets from the producer will be either compressed or uncompressed.

It is recommended to compress all the dataset files, for example HDF5 files. The ZIP compression method defined in S-100 Part 15 must be applied to the product files.

The use of compression will be encoded:

Since information about compression is encoded in the S-102_ExchangeCatalogue, it is implicitly applied to all the dataset files in the exchange set. It will not be possible to create an exchange set where some HDF5 files are compressed while others are not. In cases where a data distributor produces an integrated S-102 product, all sources are required to be either compressed or uncompressed at time of integration. In this situation the digital signature encoded into source data (that is, original data producer) will be replaced with that of the distributor (Data Server).

11.4.2 Use of Data Protection

It is recommended to encrypt all the dataset files, for example HDF5. The encryption method defined in S-100 Part 15 must be applied.

Encryption information for dataset files must be encoded:

11.4.3 Use of Digital Signatures

Digital Signatures shall be used on all files included in a S-102 compliant exchange set to meet the requirements of IMO resolution MSC.428(98) to reduce cyber security risks among users, especially when used in navigations systems at sea. The recommended signature method is defined in S-100 Part 15.

The digital signature information is encoded either in the S102_DatasetDiscoveryMetaData or the S102_CatalogueMetadata record for each file included in the exchange set.

12 Metadata

12.1 Introduction

The Metadata elements used in the Bathymetric Surface product are derived from S-100 and from ISO 19115 and ISO 19115-2. Optionally additional metadata may be derived from ISO 19130 and ISO 19130-2 especially metadata relating to the SONAR equipment which may have been used to acquire the bathymetric data.

There are only a few elements in the ISO 19115 metadata standard that are mandatory and these relate only to the use of the metadata for identification and pedigree of the data set. A minimum level of data identification is required for all applications including database applications, web services and data set production. However, S-102 requires certain metadata attributes which are used to geolocate the dataset as well as lineage attribution which define processes used to establish the tracking list and establish a pedigree for the data.

The elements are related in a metadata schema and include definitions and extension procedures. There exist both mandatory and conditional metadata elements. Only a few metadata elements are mandatory but the inclusion of some of the optional metadata elements establish a situation where other metadata elements are conditionally made mandatory.

The following table outlines the core metadata elements (mandatory and recommended optional) required for describing a geographic information data set. The codes indicate: "M" mandatory, "O" optional, "C" conditional as defined in ISO 19115. The table indicates how the mandatory, optional and conditional core metadata are handled in S-102.

Table 12.1 – S-102 Handling of Core Metadata Elements

<p>Dataset title (M) S102_DS_DiscoveryMetadata > citation > CI_Citation.title or S102_Tile_DiscoveryMetadata > citation > CI_Citation.title</p> <p>from: (MD_Metadata.identificationInfo > MD_DataIdentification.citation > CI_Citation.title)</p>	<p>Spatial representation type (O) S102_DS_DiscoveryMetadata > spatialRepresentationType: MD_DataIdentification.spatialRepresentationType or S102_Tile_DiscoveryMetadata > spatialRepresentationType: MD_DataIdentification.spatialRepresentationType</p> <p>002– Grid; (for regular grid coverage)</p> <p>from: (MD_Metadata.identificationInfo > MD_DataIdentification.spatialRepresentationType)</p>
<p>Dataset reference date (M) S102_DS_DiscoveryMetadata > citation > CI_Citation.date or S102_Tile_DiscoveryMetadata > citation > CI_Citation.date</p> <p>from: (MD_Metadata.identificationInfo > MD_DataIdentification.citation > CI_Citation.date)</p>	<p>Reference system (O) S102_StructureMetadataBlock > hRefSystem and S102_StructureMetadataBlock > vRefSystem</p> <p>from: (MD_Metadata.referenceSystemInfo > MD_ReferenceSystem.referenceSystemIdentifier > RS_Identifier)</p>
<p>Resource point of contact (O) S102_DS_DiscoveryMetadata > pointOfContact > CI_Responsibility or S102_Tile_DiscoveryMetadata > pointOfContact > CI_Responsibility</p> <p>from: (MD_Metadata.identificationInfo > MD_DataIdentification.pointOfContact > CI_Responsibility)</p>	<p>Lineage (O) S102_QualityMetadataBlock > S102_LI_Source and S102_QualityMetadataBlock > S102_LI_ProcessStep</p> <p>from: (MD_Metadata.resourceLineage >> LI_Lineage)</p>
<p>Geographic location of the dataset (by four coordinates or by geographic identifier) (C) S102_DS_DiscoveryMetadata > extent > EX_Extent or S102_Tile_DiscoveryMetadata > extent > EX_Extent</p> <p>from: (MD_Metadata.identificationInfo > MD_identification.extent > EX_Extent > EX_GeographicBoundingBox or EX_GeographicDescription)</p>	<p>On-line link to resource (O) (MD_Metadata.distributionInfo > MD_Distribution > MD_DigitalTransferOption.onLine > CI_OnlineResource)</p> <p>Optional - not required</p>

<p>Dataset language (M) S102_DS_DiscoveryMetadata > language or S102_Tile_DiscoveryMetadata > language</p> <p>from: (MD_Metadata.identificationInfo > MD_DataIdentification.language)</p>	<p>Metadata file parent identifier (C) (MD_Metadata.parentMetadata > CI_Citation.identifier)</p> <p>Implicit in S-102 product specification reference to ISO 19115-1 as a normative reference</p>
<p>Dataset character set (C) set to default = "utf8". [not required when set to default from ISO 19115]</p> <p>from: (MD_Metadata.identificationInfo > MD_DataIdentification.defaultLocale > PT_Locale.characterEncoding)</p>	<p>Metadata standard name (O) (MD_Metadata.metadataStandard > CI_Citation.title)</p> <p>Implicit in S-102 product specification reference to ISO 19115-1 as a normative reference</p>
<p>Dataset topic category (M) S102_DS_DiscoveryMetadata > topicCategory: Or S102_Tile_DiscoveryMetadata > topicCategory:</p> <p>MD_TopicCategoryCode 006– elevation; 014– oceans; 012– inlandWaters</p> <p>From: (MD_Metadata.identificationInfo > MD_Identification.topicCategory)</p>	<p>Metadata standard version (O) (MD_Metadata.metadataStandardVersion)</p> <p>Implicit in S-102 product specification reference to ISO 19115-1 as a normative reference</p>
<p>Spatial resolution of the dataset (O) (MD_Metadata.identificationInfo > MD_DataIdentification.spatialResolution > MD_Resolution.equivalentScale or MD_Resolution.distance)</p> <p>Since this data set is a grid coverage resolution is defined by the coverage grid parameters</p>	<p>Metadata language (C) (MD_Metadata.defaultLocale > PT_Locale.language)</p> <p>The language is set to English. In addition, additional languages may be used in accordance with the structure for handling multi-languages per ISO 19115-1</p>
<p>Abstract describing the dataset (M) S102_DS_DiscoveryMetadata > abstract or S102_Tile_DiscoveryMetadata > abstract</p> <p>from: (MD_Metadata.identificationInfo > MD_DataIdentification.abstract)</p>	<p>Metadata character set (C) set to default = "utf8". [not required when set to default from ISO 19115-1]</p> <p>from: (MD_Metadata.defaultLocale > PT_Locale.characterEncoding)</p>
<p>Distribution format (O) (MD_Metadata.distributionInfo > MD_Distribution > MD_Format)</p> <p>Optional - not applicable</p> <p>To maintain the separation of carrier and content the content model does not contain any format information. This would be included in a transmittal or by file types.</p>	<p>Party responsible for the metadata information (M) S102_DS_DiscoveryMetadata > contact or S102_Tile_DiscoveryMetadata > contact</p> <p>from: (MD_Metadata.contact > CI_Responsibility.CI_Individual or MD_Metadata.contact > CI_Responsibility.CI_Organisation)</p>

<p>Temporal extent information for the dataset (O)</p> <p>(MD_Metadata.identificationInfo > MD_Identification.extent > EX_Extent.temporalElement</p>	<p>Date(s) associated with the metadata (M)</p> <p>S102_DS_DiscoveryMetadata > dateInfo or S102_Tile_DiscoveryMetadata > dateInfo</p> <p>from: (MD_Metadata.dateInfo > CI_Date)</p>
<p>Vertical extent information for the dataset (O)</p> <p>MD_Metadata.identificationInfo > MD_DataIdentification.extent > EX_Extent.verticalElement > EX_VerticalExtent</p>	<p>Name of the scope/type of resource for which the metadata is provided (M)</p> <p>S102_DS_DiscoveryMetadata > resourceScope or S102_Tile_DiscoveryMetadata > resourceScope</p> <p>from: (MD_Metadata.metadataScope > MD_MetadataScope.resourceScope > MD_ScopeCode (codelist – ISO 19115-1))</p>

12.2 Discovery Metadata

Metadata is used for a number of purposes. One high level purpose is for the identification and discovery of data. Every data set needs to be identified so that it can be distinguished from other data sets and so it can be found in a data catalogue, such as a Web Catalogue Service. The discovery metadata applies at the **S102_DataSet** level and at the **S102_IG_Collection** level. That is, there is discovery data for the whole data set and for those data sets that are composed of several tiles there is also equivalent discovery metadata for each tile.

Metadata in **S102_DiscoveryMetadataBlock** is encoded as embedded metadata in the HDF5 file at Level 2 or Level 3 (see clause 10.2) depending on whether it applies to a single feature instance, tile, or to all instances of a feature class or all tiles.

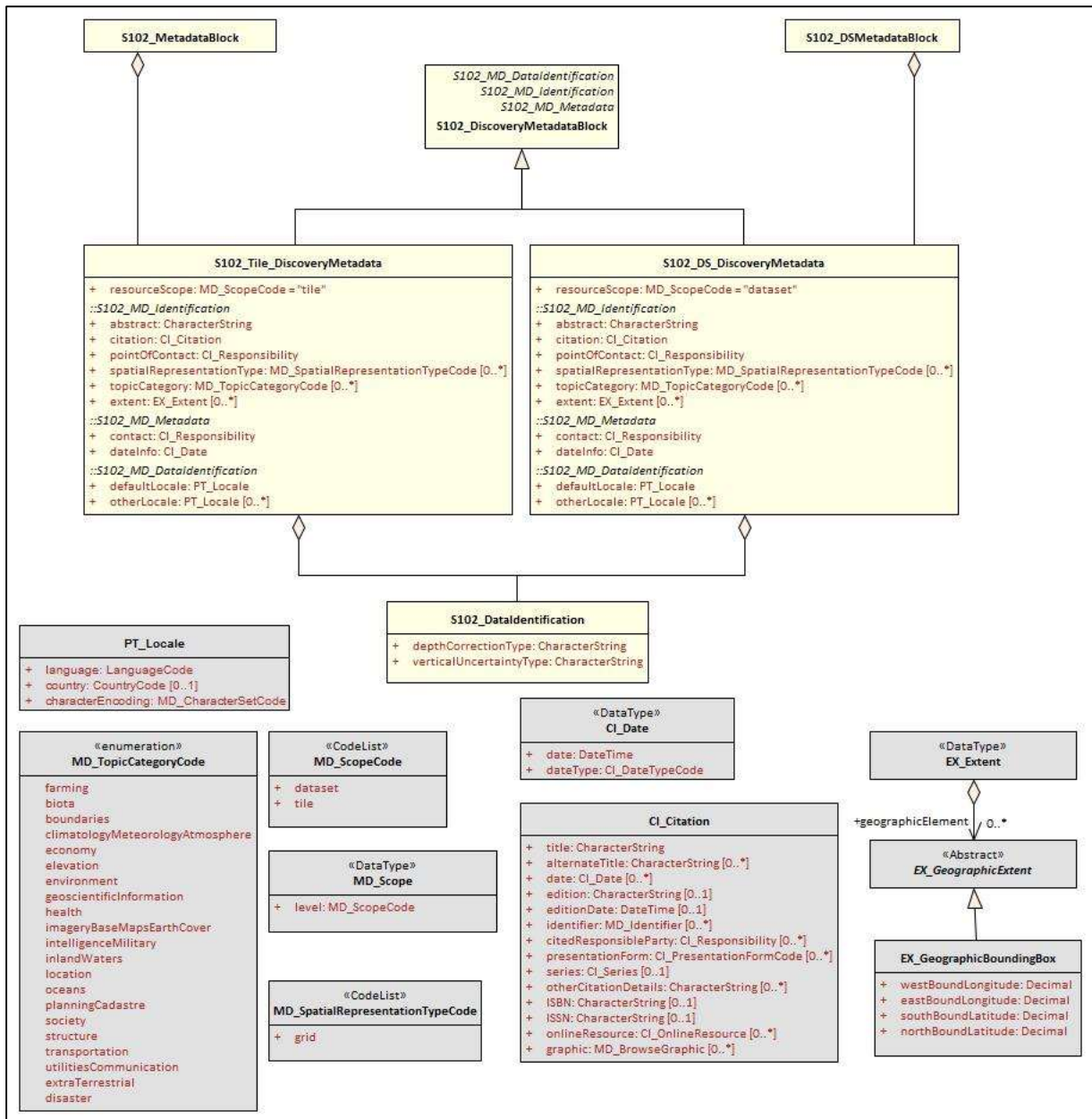

Figure 12.1 - S-102 Discovery Metadata

Figure 12.1 shows the **S102_DiscoveryMetadataBlock**. It has two subtypes **S102_DS_DiscoveryMetadata** and **S102_Tile_DiscoveryMetadata**. The only difference is that the *resourceScope* is set to "dataset" for the whole data set and "tile" for a tile. These two classes implement the metadata classes from ISO 19115. First implementation classes have been developed corresponding to each of the ISO 19115 classes that have been referenced in which only the applicable attributes have been included. The classes **S102_DS_DiscoveryMetadata** and **S102_Tile_DiscoveryMetadata** inherit their attributes from these S-102 specific implementation classes. In addition, an additional component **S102_DataIdentification** has been added.

This model provides the minimum amount of metadata for a Bathymetry Surface data product. Any of the additional optional metadata elements from the source ISO 19115 metadata standard can also be included.

Table 12.2 provides a description of each attribute of the **S102_DiscoveryMetadataBlock** class attributes.

Table 12.2 - S102_DiscoveryMetadataBlock class attributes

Role Name	Name	Description	Mult	Type	Remarks
Class	S102_DiscoveryMetadataBlock	Container class for discovery metadata	-	-	
Class	S102_DS_DiscoveryMetadata	Container class for discovery metadata related to an entire data set	-	-	
Class	S102_Tile_DiscoveryMetadata	Container class for discovery metadata related to a particular tile when there are multiple tiles in a data set	-	-	
attribute	resourceScope		1	MD_ScopeCode	"dataset" for S102_DS_DiscoveryMetadata or "tile" for S102_Tile_DiscoveryMetadata
attribute	abstract	Brief narrative summary of the content of the resource(s)	1	CharacterString	
attribute	citation	Citation data for the resource(s)	1	CI_Citation	CI_Citation <<DataType>> Required items are Citation.title, & Citation.date,
attribute	pointOfContact	Identification of, and means of communication with, person(s) and organization(s) associated with the resource(s)	1	CI_Responsibility	See S-100 Part 4a Tables 4a-2 and 4a-3 for required items
attribute	spatialRepresentationType	Method used to spatially represent geographic information	1	MD_SpatialRepresentationTypeCode	MD_SpatialRepresentationTypeCode <<CodeList>> 002– Grid; (for regular grid coverage) 001– Vector; (for tracking list discrete point coverage)
attribute	topicCategory	Main theme(s) of the dataset	1..*	MD_TopicCategoryCode	MD_TopicCategoryCode <<Enumeration>> 006– elevation 014– oceans 012– inlandWaters
attribute	extent	Extent information including the bounding box, bounding polygon, vertical, and temporal extent of the dataset	0..1	EX_Extent	EX_Extent <<DataType>> If this attribute is present, the four bounding box sub-attributes westBoundLongitude, etc., must be populated
attribute	contact	Party responsible for the metadata information	1	CI_Responsibility>CI_Organisation or CI_Responsibility>CI_Individual	See S-100 Part 4a Tables 4a-2 and 4a-3 for required items

Role Name	Name	Description	Mult	Type	Remarks
attribute	dateInfo	Date that the metadata was created	1	CI_Date (dateInfo.dateType = 'creation')	
attribute	defaultLocale	Default language and character set used in the exchange catalogue	1	PT_Locale (defaultLocale.language = ISO 639-2/T code)	Populate 'language' from ISO 639-2/T list of languages, default "eng". For example: defaultLocale.language="eng" for English defaultLocale.language="fra" for French
attribute	otherLocale	Other languages and character sets used in the exchange catalogue	0..*	PT_Locale (otherLocale.language = ISO 639-2/T code)	Populate 'language' from ISO 639-2/T list of languages. otherLocale need be populated only if the dataset uses more than one language
Class	S102_DataIdentification	Component for S102_DiscoveryMetadata Block. Extension beyond ISO 19115 metadata	-	-	
attribute	depthCorrectionType	Code defining the type of sound velocity correction made to the depths	1	CharacterString	see Table 12.3
attribute	verticalUncertaintyType	Code defining how uncertainty was determined	1	CharacterString	see Table 12.4

The class **S102_DataIdentification** provides an extension to the metadata available from ISO 19115. The verticalUncertaintyType attribute was added to accurately describe the source and meaning of the encoded Uncertainty coverage. The depthCorrectionType was also added to define if and how the depths are corrected (that is, true depth, depth ref 1500 m/sec, etc.). Tables 12.3 and 12.4 provide a description.

Table 12.3 - Code defining the type of sound velocity correction

Value	Definition
SVP_Applied	Sound velocity field measured and applied (True Depth)
1500_MS	Assumed sound velocity of 1500 m/s used
1463_MS	Assumed sound velocity of 1463 m/s used (Equivalent to 4800 ft./s)
NA	Depth not measured acoustically
Carters	Depths corrected using Carter's Tables
Unknown	

Table 12.4 - Code defining how uncertainty was determined

Value	Definition
Unknown	"Unknown" - The uncertainty layer is an unknown type
Raw_Std_Dev	"Raw Standard Deviation" - Raw standard deviation of soundings that contributed to the node
CUBE_Std_Dev	Dev "CUBE Standard Deviation " - Standard deviation of soundings captured by a CUBE hypothesis (that is, CUBE's standard output of uncertainty)
Product_Uncert	"Product Uncertainty" - NOAA standard product uncertainty V1.0 (a blend of CUBE uncertainty and other measures)
Historical_Std_Dev	"Historical Standard Deviation " – Estimated standard deviation based on historical/archive data

12.3 Structure Metadata

Structure metadata is used to describe the structure of an instance of a collection, including any reference to a tiling scheme. Since constraints can be different on separate files (for example they could be derived from different legal sources), or security constraints may be different, the constraint information becomes part of the structure metadata. The other structure metadata is the grid representation and the reference system.

Figure 12.2 shows the **S102_StructureMetadataBlock**. The metadata block is generated by the inheritance of attributes from a number of ISO 19115 metadata classes, and S-100 class for tiling and two implementation classes for the horizontal and vertical reference system. This makes the metadata block a simple table.

Metadata in **S102_StructureMetadataBlock** is encoded as embedded metadata in the HDF5 file at Level 2 or Level 3 (see clause 10.2) depending on whether it applies to a single feature instance, tile, or to all instances of a feature class or all tiles.

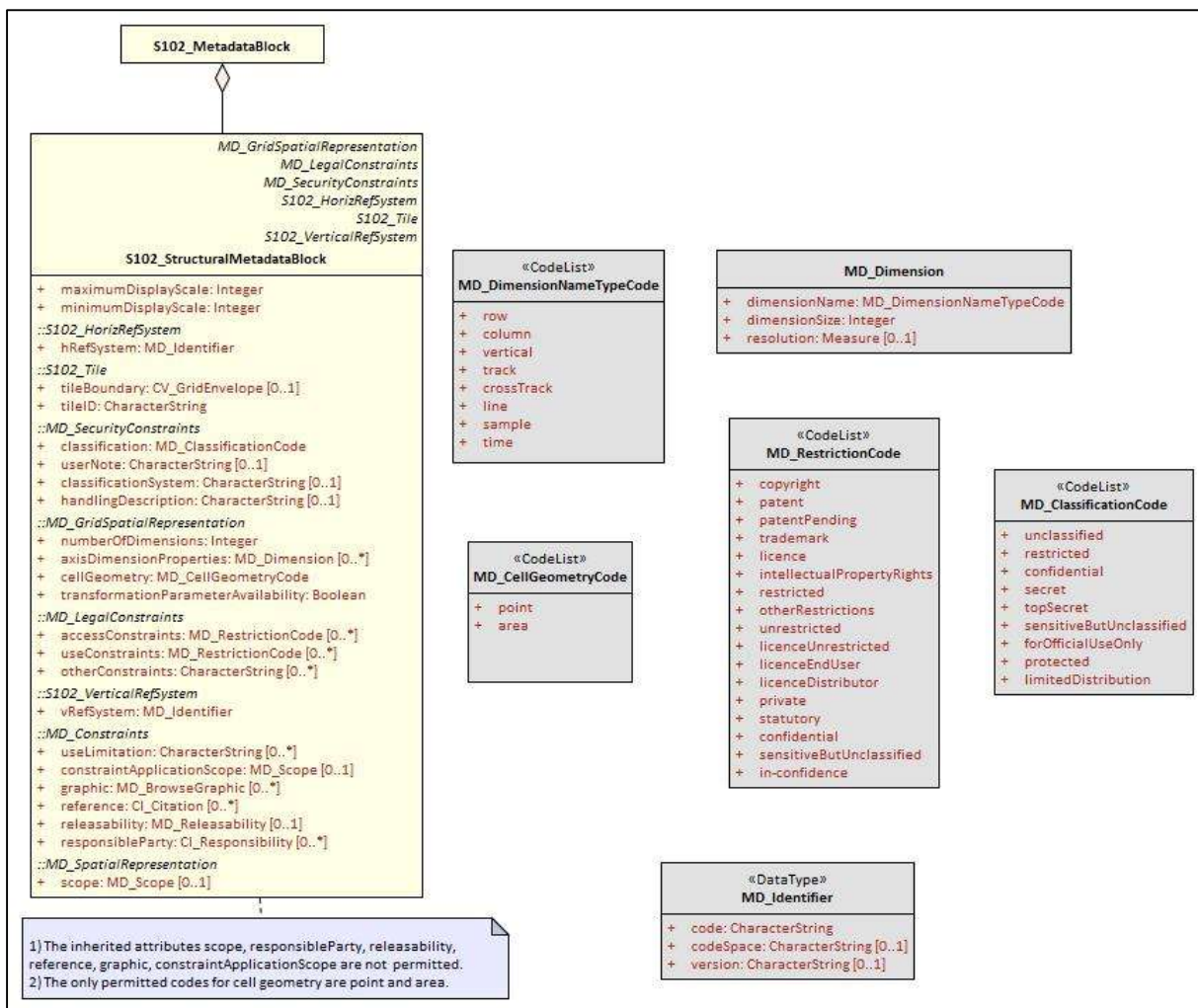

Figure 12.2 – S-102 Structure Metadata

Table 12.5 - S102_StructureMetadataBlock class attributes

Role Name	Name	Description	Mult	Type	Remarks
Class	S102_StructuralMetadataBlock	Container class for structural metadata	-	-	
attribute	maximumDisplayScale	Maximum display scale for the bathymetry coverage	1	Integer	
attribute	minimumDisplayScale	Minimum display scale for the bathymetry coverage	1	Integer	
attribute	numberOfDimensions	Number of independent spatial/temporal axes	1	Integer	Default = 2 No other value is allowed
attribute	axisDimensionProperties	Information about spatial-temporal axis properties	1	MD_Dimension	MD_Dimension <<DataType>> dimensionName and dimensionSize
attribute	cellGeometry	Identification of grid data as point or cell	1	MD_CellGeometryCode	

Role Name	Name	Description	Mult	Type	Remarks
attribute	transformationParameterAvailability	Indication of whether or not parameters for transformation between image coordinates and geographic or map coordinates exist (are available)	1	Boolean	1 = yes 0 = no Mandatory and must be 1.
attribute	vRefSystem	Name of vertical reference system	1	MD_Identifier > code, codespace, version	Must be the identifier of a vertical reference system
attribute	hRefSystem	Name of horizontal reference system	1	MD_Identifier > code, codespace, version	Must be the identifier of a vertical reference system from Table 5-1 – EPSG Codes
attribute	accessConstraints	Access constraints applied to assure the protection of privacy or intellectual property, and any special restrictions or limitations on obtaining the dataset	0..*	MD_Restriction Code	
attribute	useConstraints	Constraints applied to assure the protection of privacy or intellectual property, and any special restrictions or limitations or warnings on using the dataset	0..*	MD_Restriction Code	
attribute	otherConstraints	Other restrictions and legal prerequisites for accessing and using the dataset	0..*	CharacterString	
attribute	classification	Name of the handling restrictions on the dataset	1	MD_ClassificationCode	
attribute	userNote	Additional information about the classification	0-1	CharacterString	
attribute	classificationSystem	Name of the classification system	0..1	CharacterString	
attribute	handlingDescription	Additional information about the restrictions on handling the dataset	0..1	CharacterString	
attribute	tileID	Tile identifier	1	CharacterString	
attribute	tileBoundary	Tile boundary	0..1	GM_Curve	When not provided is assumed to be the extent of the collection as defined by EX_Extent
Class	MD_Dimension	Axis properties	-	-	
attribute	dimensionName	Name of axis	1	MD_DimensionTypeCode	Defaults are "row" and "column". No other value is allowed
attribute	dimensionSize	Number of elements along the axis	1	Integer	
attribute	resolution	Degree of detail in the grid dataset	0..1	Measure	value= number

12.3.1 Quality Metadata

Quality metadata is used to describe the quality of the data in an instance of a collection. Figure 7 shows the **S102_QualityMetadataBlock**. The **S102_QualityMetadataBlock** derives directly from the ISO 19115 class **DQ_DataQuality**. However, its components **S102_LI_Source** and **S102_LI_ProcessStep** are generated by the inheritance of attributes from the ISO 19115 classes **LI_Scope** and **LI_ProcessStep**. Only some of the attributes of the referenced ISO 19115 classes are implemented. In addition, the class **S102_ProcessStep** has been added. This extension allows internal Tracking List entries to be associated with a unique entry in the metadata so that the changes can be properly attributed, described and easily referenced.

Metadata in **S102_QualityMetadataBlock** is encoded as embedded metadata in the HDF5 file at Level 2 or Level 3 (see clause 10.2) depending on whether it applies to a single feature instance, tile, or to all instances of a feature class or all tiles.

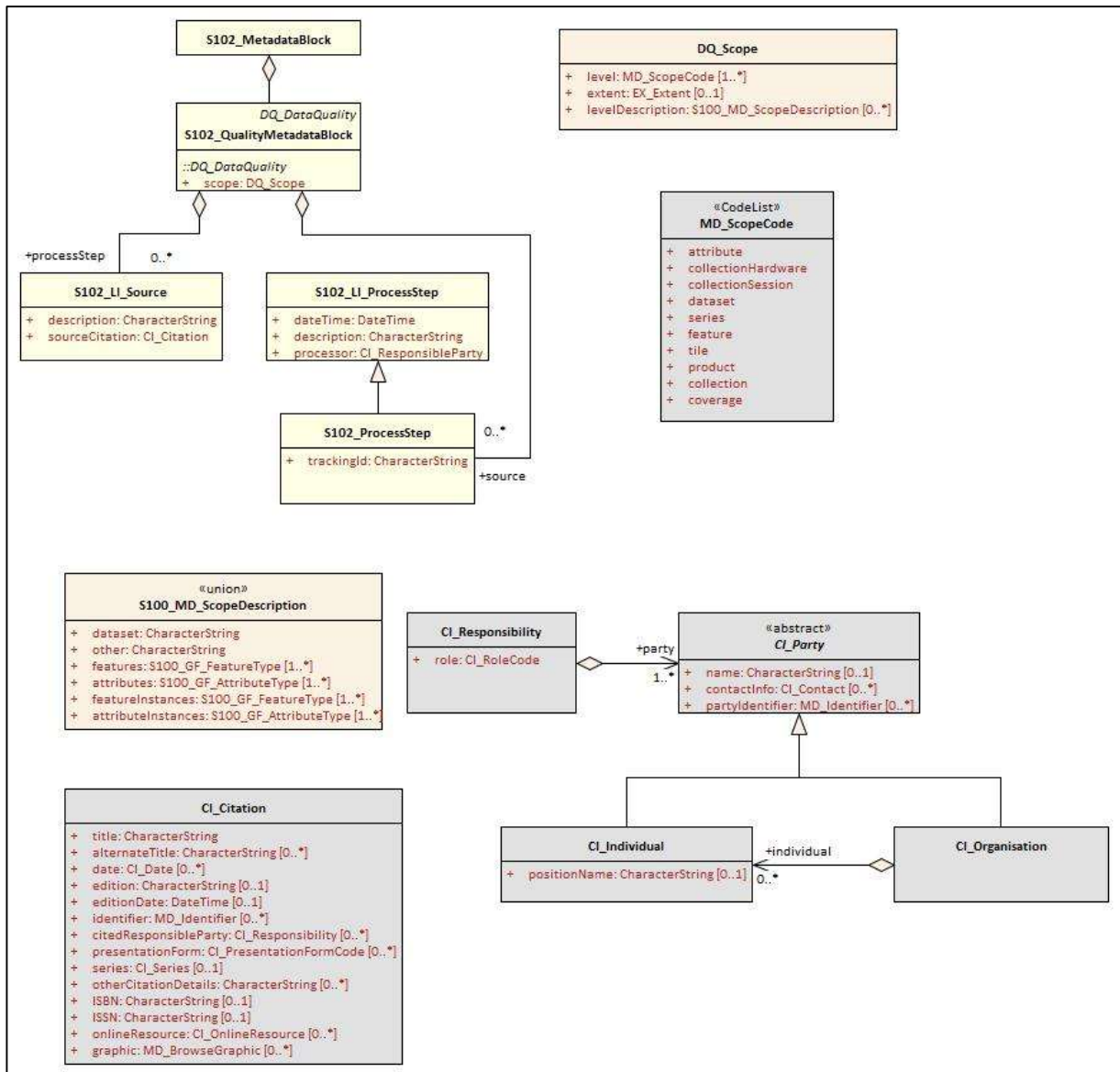

Figure 12.3 - S-102 Quality Metadata

Table 12.6 provides a description of each attribute of the S102_QualityMetadataBlock class attributes and those of its components.

Table 12.6 - Quality Metadata Block description

Role Name	Name	Description	Mult	Type	Remarks
Class	S102_QualityMetadataBlock	Container class for quality metadata	-	-	
attribute	scope	Extent of characteristic(s) of the data for which quality information is reported	1	DQ_Scope	
Class	S102_LI_Source	Information about the source data used in creating the data specified by the scope	-	-	
attribute	description	Detailed description of the level of the source data	1	CharacterString	
attribute	sourceCitation	Recommended reference to be used for the source data	1	CI_Citation	Required items are citation.title and citation.date
Class	S102_LI_ProcessStep	Information about an event or transformation in the life of a dataset including the process used to maintain the dataset	-	-	
attribute	dateTime	Date and time or range of date and time on or over which the process step occurred	1	CharacterString	
attribute	description	Description of the event, including related parameters or tolerances	1	CharacterString	
attribute	processor	Identification of, and means of communication with, person(s) and organization(s) associated with the process step	1	CI_Responsibility	See S-100 Part 4a Tables 4a-2 and 4a-3 for required items
Class	S102_ProcessStep	Management of tracking list references to LI_ProcessStep	-	-	
attribute	trackingId	ID reference used so that Tracking List entries can be associated with a unique entry in the metadata so that the changes can be properly attributed, described and easily referenced	1	CharacterString	
Class	DQ_Scope	Container class for quality metadata	-	-	
attribute	level	Hierarchical level of the data specified by the scope	0..*	MD_ScopeCode <<CodeList>>	"dataset" or "tile"
attribute	extent	Information about the horizontal, vertical and temporal extent of the data specified by the scope	0..*	EX_Extent <<DataType>>	Used only if the extent of the data is different from the EX_Extent given for the collection / tile
attribute	levelDescription	Detailed description about the level of the data specified by the scope	1	MD_ScopeDescription <<Union>>	

12.3.2 Acquisition Metadata

Acquisition metadata to a Bathymetric Surface Product Specification profile that they are developing nationally. The classes derive from ISO 19115, 19115-2, 19130 and 19130-2. The later document 19130-2 contains description of SONAR parameters.

12.4 Exchange Set Metadata

For information exchange, there are several categories of metadata required: metadata about the overall exchange catalogue, metadata about each of the datasets contained in the catalogue.

Figures 12.4 to 12.7 outline the overall concept of an S-102 exchange set for the interchange of geospatial data and its relevant metadata. Figure 12.4 depicts the realization of the ISO 19139 classes which form the foundation of the exchange set. The overall structure of S-102 metadata for exchange sets is modelled in Figures 12.5 and 12.6. More detailed information about the various classes is shown in Figure 12.7 and a textual description in the tables at clause 12.6.

The discovery metadata classes have numerous attributes which enable important information about the datasets to be examined without the need to process the data, for example, decrypt, decompress, load etc. Other catalogues can be included in the exchange set in support of the datasets such as feature and portrayal.

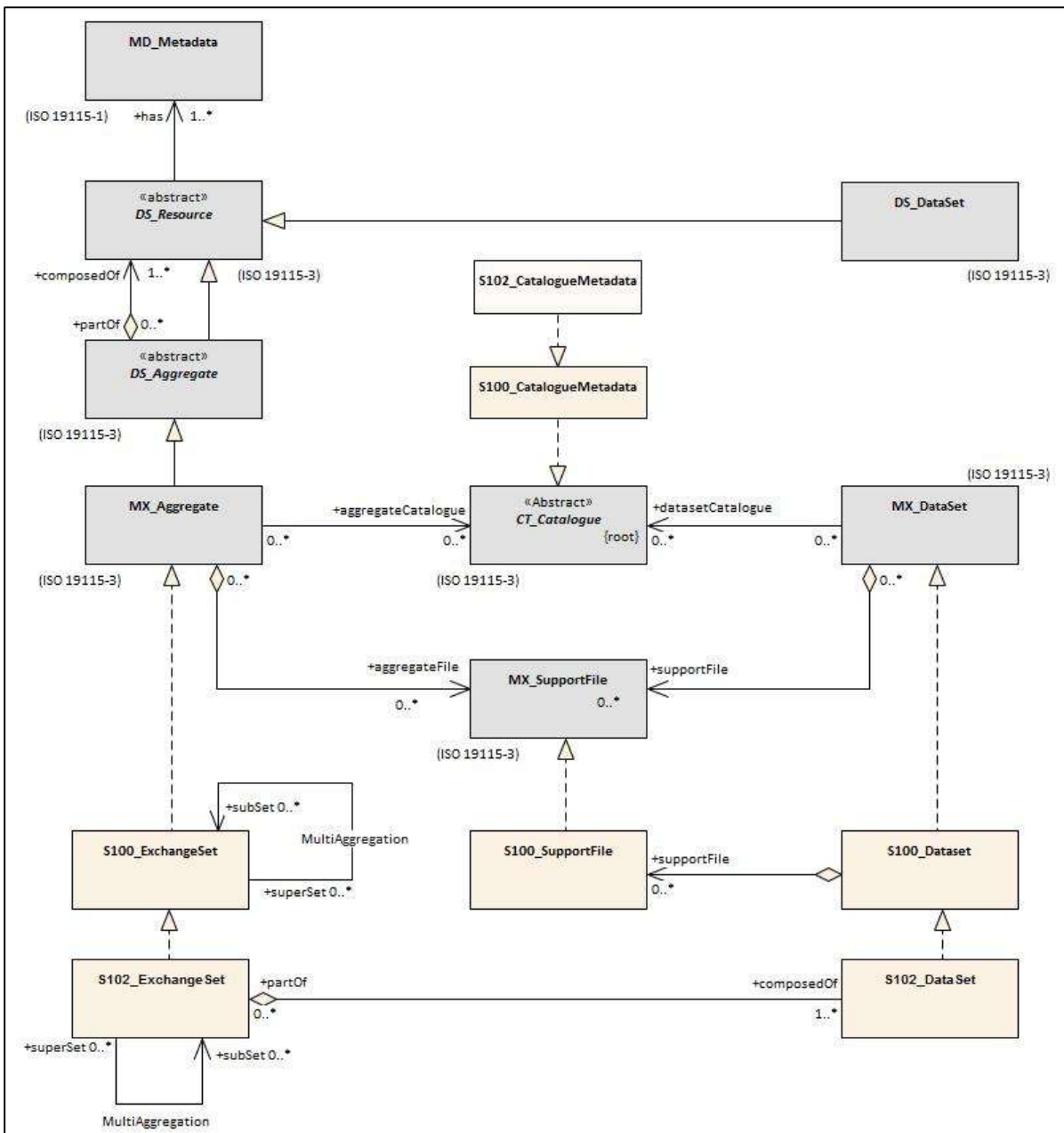

Figure 12.4 - Realization of the Exchange Set classes

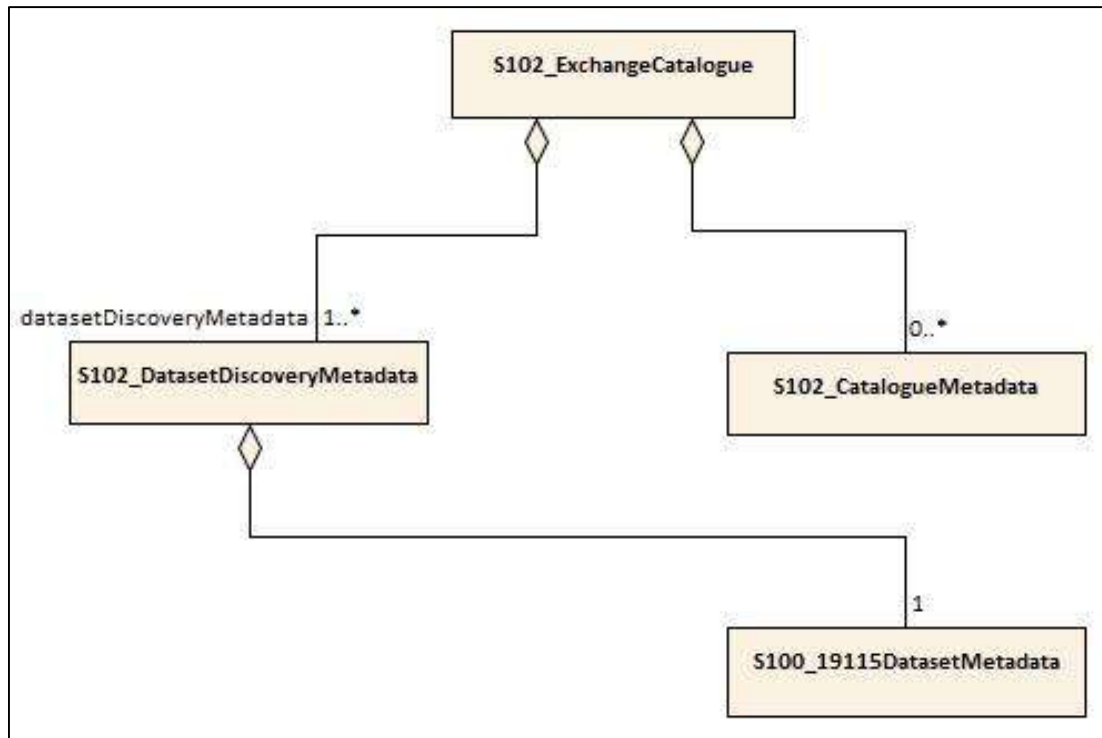

Figure 12.5 - S-102 Exchange Set Catalogue

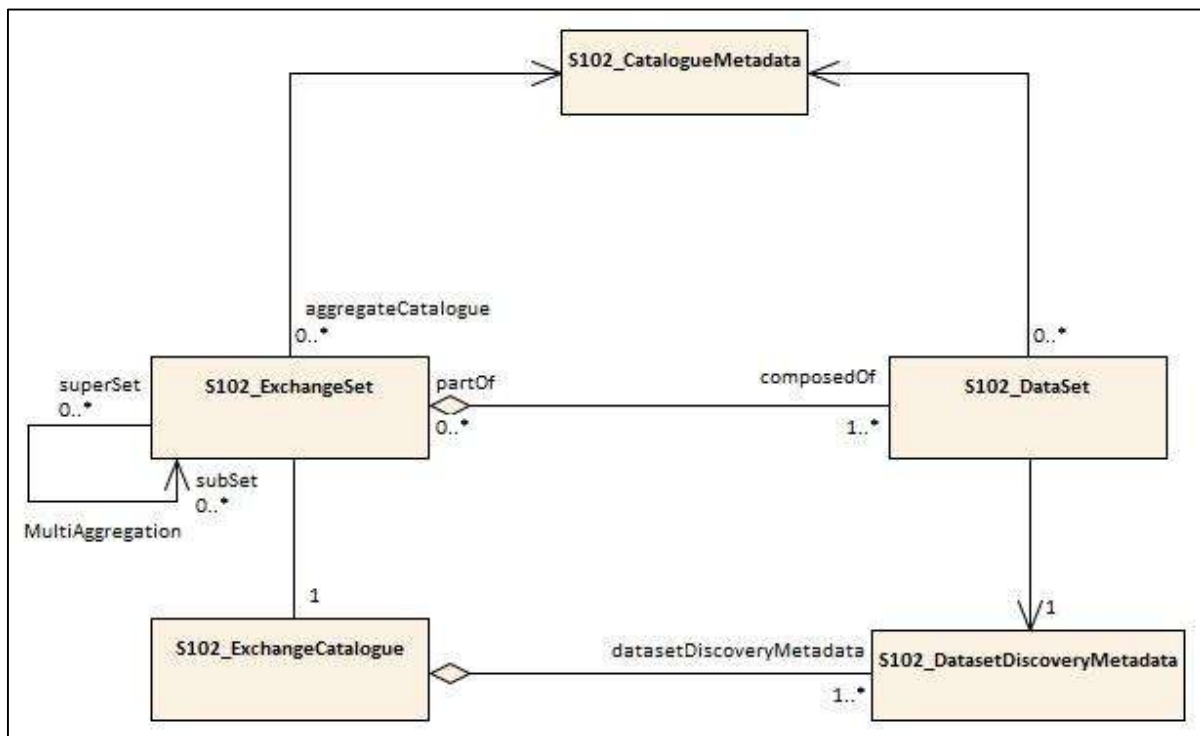

Figure 12.6 - S-102 Exchange Set

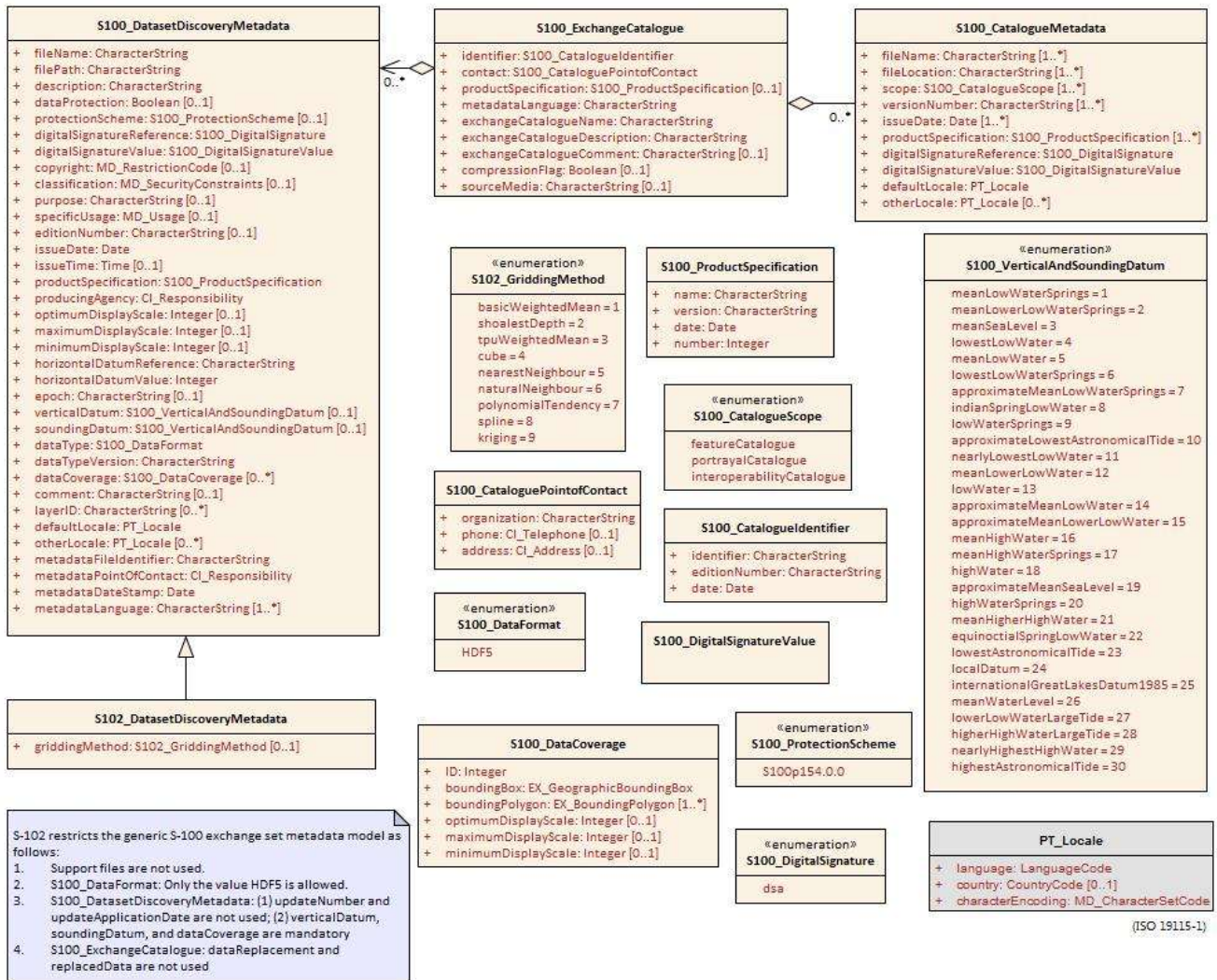

Figure 12.7 - S-102 Exchange Set - class details

The following clauses define the mandatory and optional metadata needed for S-102. In some cases, the metadata may be repeated in a national language. If this is the case it is noted in the Remarks column.

The XML schemas for S-102 exchange catalogues will be available from the IHO GI Registry and/or the S-100 GitHub site (<https://github.com/IHO-S100WG>).

12.5 Language

The exchange language must be English.

Character strings must be encoded using the character set defined in ISO 10646-1, in Unicode Transformation Format-8 (UTF-8). A BOM (byte order mark) must not be used.

Page intentionally left blank

12.6 S102_ExchangeCatalogue

Each exchange set has a single S100_ExchangeCatalogue which contains meta information for the data and support files in the exchange set.

The class S102_ExchangeCatalogue is realized from S100_ExchangeCatalogue without modification. S-102 restricts certain attributes and roles as described in the table below. S102_ExchangeCatalogue is a container substituting for the corresponding S100_ExchangeCatalogue class in the UML diagram. It is needed because S-102 extends S-100 discovery metadata.

Role name	Name	Description	Mult	Type	Remarks
Class	S100_ExchangeCatalogue	An exchange catalogue contains the discovery metadata about the exchange datasets and support files	-	-	The optional S-100 attributes replacedData and dataReplacement are not used in S-102 Support file discovery metadata is not permitted because S-102 does not use support files
Attribute	identifier	Uniquely identifies this exchange catalogue	1	S100_CatalogueIdentifier	
Attribute	contact	Details about the issuer of this exchange catalogue	1	S100_CataloguePointOfContact	
Attribute	productSpecification	Details about the product specifications used for the datasets contained in the exchange catalogue	0..1	S100_ProductSpecification	Conditional on all the datasets using the same product specification
Attribute	metadataLanguage	Details about the Language	1	CharacterString	
Attribute	exchangeCatalogueName	Catalogue filename	1	CharacterString	In S-102 is CATLOG.102
Attribute	exchangeCatalogueDescription	Description of what the exchange catalogue contains	1	CharacterString	
Attribute	exchangeCatalogueComment	Any additional Information	0..1	CharacterString	
Attribute	compressionFlag	Is the data compressed	0..1	Boolean	Yes or No
Attribute	sourceMedia	Distribution media	0..1	CharacterString	
Role	datasetDiscoveryMetadata	Exchange catalogues may include or reference discovery metadata for the datasets in the exchange set	0..*	Aggregation S100_DatasetDiscoveryMetadata	
Role	--	Metadata for catalogue	0..*	Aggregation S100_CatalogueMetadata	Metadata for the feature, portrayal, and interoperability catalogues, if any

12.6.1 S100_CatalogueIdentifier

S-102 uses S100_CatalogueIdentifier without modification.

Role name	Name	Description	Mult	Type	Remarks
Class	S100_CatalogueIdentifier	An exchange catalogue contains the discovery metadata about the exchange datasets and support files	-	-	-
Attribute	identifier	Uniquely identifies this exchange catalogue	1	CharacterString	
Attribute	editionNumber	The edition number of this exchange catalogue	1	CharacterString	
Attribute	date	Creation date of the exchange catalogue	1	Date	

12.6.2 S100_CataloguePointofContact

S-102 uses S100_CataloguePonitOfContact without modification.

Role name	Name	Description	Mult	Type	Remarks
Class	S100_CataloguePointOfContact	Contact details of the issuer of this exchange catalogue	-	-	-
Attribute	organization	The organization distributing this exchange catalogue	1	CharacterString	This could be an individual producer, value added reseller, etc
Attribute	phone	The phone number of the organization	0..1	CI_Telephone	
Attribute	address	The address of the organization	0..1	CI_Address	

12.7 S102_DatasetDiscoveryMetadata

Dataset discovery metadata in S-102 is an extension of the generic S-100 metadata class S100_DatasetDiscoveryMetadata. S-102 adds the attribute *griddingMethod* which describes the algorithm used to calculate grid values. S-102 also restricts certain attributes and roles as described in the table below.

Role name	Name	Description	Mult	Type	Remarks
Class	S102_DatasetDiscoveryMetadata	Metadata about the individual datasets in an S-102 exchange set	-	-	Extension of S100_DatasetDiscoveryMetadata

Role name	Name	Description	Mult	Type	Remarks
Attribute	griddingMethod	Algorithm used to calculate grid values	0..1	S102_GriddingMethod	<ol style="list-style-type: none"> 1. basicWeightedMean 2. shoalestDepth 3. tpuWeightedMean 4. cube 5. nearestNeighbour 6. naturalNeighbour 7. polynomialTendency 8. spline 9. kriging
Class	S100_DatasetDiscoveryMetadata	Metadata about the individual datasets in the exchange catalogue	-	-	<p>The optional S-100 attributes updateApplicationNumber and updateApplicationDate are not used in S-102</p> <p>References to support file discovery metadata are not permitted because S-102 does not use support files</p> <p>Optional S-100 attributes which are mandatory in S-102 are indicated in the Remarks column</p>
Attribute	fileName	Dataset file name	1	CharacterString	<p>Dataset file name according to format defined in clause 11.2.3</p> <p>102+PPPP+00000000000000.H5</p>
Attribute	filePath	Full path from the exchange set root directory	1	CharacterString	<p>Path relative to the root directory of the exchange set. The location of the file after the exchange set is unpacked into directory <EXCH_ROOT> will be <EXCH_ROOT>/<filePath>/<filename></p>
Attribute	description	Short description giving the area or location covered by the dataset	1	CharacterString	<p>For example a harbour or port name, between two named locations etc</p>
Attribute	dataProtection	Is the data encrypted	1	Boolean	<p>True or False.</p>
Attribute	protectionScheme	Specification or method used for data protection	0..1	S100_ProtectionScheme	<p>In S-100 Edition 4.0.0 the only allowed value is "S100p154.0.0"</p>
Attribute	digitalSignature	Digital Signature of the file	1	S100_DigitalSignature	<p>Specifies the algorithm used to compute digitalSignatureValue. In S-100 Edition 4.0.0 the only allowed value is "dsa"</p>
Attribute	digitalSignatureValue	Value derived from the digital signature	1	S100_DigitalSignatureValue	<p>The value resulting from application of digitalSignatureReference</p> <p>Implemented as the digital signature format specified in S-100 Part 15</p>

Role name	Name	Description	Mult	Type	Remarks
Attribute	copyright	Indicates if the dataset is copyrighted	0..1	MD_LegalConstraints - >MD_RestrictionCode <copyright> (ISO 19115-1)	
Attribute	classification	Indicates the security classification of the dataset	0..1	Class MD_SecurityConstraints>MD_ClassificationCode (codelist)	1. unclassified 2. restricted 3. confidential 4. secret 5. top secret 6. sensitive but unclassified 7. for official use only 8. protected 9. limited distribution
Attribute	purpose	The purpose for which the dataset has been issued	1	Class MD_Identification>purpose	1. navigation 2. other
Attribute	specificUsage	The use for which the dataset is intended	1	MD_USAGE>specificUsage (character string) MD_USAGE>userContactInfo (CI_Responsibility)	For example, in the case of ENC's this would be a navigation purpose classification
Attribute	editionNumber	The edition number of the dataset	1	CharacterString	When a data set is initially created, the edition number 1 is assigned to it. The edition number is increased by 1 at each new edition. Edition number remains the same for Update and Re-issue
Attribute	issueDate	Date on which the data was made available by the data producer	1	Date	
Attribute	issueTime	Time of day at which the data was made available by the data producer	0..1	Time	The S-100 datatype Time
Attribute	productSpecification	The product specification used to create this dataset	1	S100_ProductSpecification	
Attribute	producingAgency	Agency responsible for producing the data	1	CI_Responsibility>CI_Organisation or CI_Responsibility>CI_Individual	See S-100 Part 4a Tables 4a-2 and 4a-3
Attribute	optimumDisplayScale	The scale with which the data is optimally displayed	0..1	Integer	Example: A scale of 1:22000 is encoded as 22000
Attribute	maximumDisplayScale	The maximum scale with which the data is displayed	0..1	Integer	
Attribute	minimumDisplayScale	The minimum scale with which the data is displayed	0..1	Integer	

Role name	Name	Description	Mult	Type	Remarks
Attribute	horizontalDatumReference	Reference to the register from which the horizontal datum value is taken	1	CharacterString	EPSG
Attribute	horizontalDatumValue	Horizontal Datum of the entire dataset	1	Integer	
Attribute	epoch	Code denoting the epoch of the geodetic datum used by the CRS	0..1	CharacterString	For example, G1762 (for the 2013-10-16 realization of the geodetic datum for WGS84) or 20131016 in simple date format
Attribute	verticalDatum	Vertical Datum of the entire dataset	1	S100_VerticalAndSoundingDatum	This optional S-100 attribute is mandatory in S-102
Attribute	soundingDatum	Sounding Datum of the entire dataset	1	S100_VerticalAndSoundingDatum	This optional S-100 attribute is mandatory in S-102
Attribute	dataType	The encoding format of the dataset	1	S100_DataFormat	The only allowed value is HDF5
Attribute	otherDataTypeDescription	Encoding format other than those listed.	0..1	CharacterString	
Attribute	dataTypeVersion	The version number of the dataType.	1	CharacterString	
Attribute	dataCoverage	Provides information about data coverages within the dataset	1..*	S100_DataCoverage	This optional S-100 attribute is mandatory in S-102
Attribute	comment	Any additional information	0..1	CharacterString	
Attribute	layerID	Identifies other layers with which this dataset is intended to be used or portrayed	0..*	CharacterString	For example, a marine protected area dataset needs an ENC dataset to portray as intended in an ECDIS Example: "S-101" for bathymetry datasets intended as overlays for S-101 ENC data
Attribute	defaultLocale	Default language and character set used in the exchange catalogue	1	PT_Locale	Default language is English, encoded as defaultLocale.language = "eng"
Attribute	otherLocale	Other languages and character sets used in the exchange catalogue	0..*	PT_Locale	
Attribute	metadataFileIdentifier	Identifier for metadata file	1	CharacterString	For example, for ISO 19115-3 metadata file
Attribute	metadataPointOfContact	Point of contact for metadata	1	CI_Responsibility>CI_Individual or CI_Responsibility>CI_Organisation	See S-100 Part 4a Tables 4a-2 and 4a-3
Attribute	metadataDateStamp	Date stamp for metadata	1	Date	May or may not be the issue date
Attribute	metadataLanguage	Language(s) in which the metadata is provided	1..*	CharacterString	

12.7.1 S100_DataCoverage

S-102 uses S100_DataCoverage without modification.

Role name	Name	Description	Mult	Type	Remarks
Class	S100_DataCoverage		-	-	-
Attribute	ID	Uniquely identifies the coverage	1	Integer	-
Attribute	boundingBox	The extent of the dataset limits	1	EX_GeographicBoundingBox	-
Attribute	boundingPolygon	A polygon which defines the actual data limit	1..*	EX_BoundingPolygon	-
Attribute	optimumDisplayScale	The scale with which the data is optimally displayed	0..1	Integer	Example: A scale of 1:25000 is encoded as 25000
Attribute	maximumDisplayScale	The maximum scale with which the data is displayed	0..1	Integer	
Attribute	minimumDisplayScale	The minimum scale with which the data is displayed	0..1	Integer	

12.7.2 S100_DigitalSignature

S-102 uses S100_DigitalSignature without modification.

Role name	Name	Description	Code	Remarks
Enumeration	S100_DigitalSignature	Algorithm used to compute the digital signature	-	-
Value	dsa	Digital Signature Algorithm	-	FIPS 186-4 (2013). See S-100 Part 15

12.7.3 S100_DigitalSignatureValue

S-102 uses S100_DigitalSignatureValue without modification.

Role Name	Name	Description	Mult	Type	Remarks
Class	S100_DigitalSignatureValue	Signed Public Key plus the digital signature	-	-	Data type for digital signature values. See S-100 Part 15

12.7.4 S100_VerticalAndSoundingDatum

S-102 uses S100_VerticalAndSoundingDatum without modification.

Role Name	Name	Description	Code	Type	Remarks
Enumeration	S100_VerticalAndSoundingDatum	Allowable vertical and sounding datums	-		-
Value	meanLowWaterSprings		1		(MLWS)
Value	meanLowerLowWaterSprings		2		
Value	meanSeaLevel		3		(MSL)
Value	lowestLowWater		4		
Value	meanLowWater		5		(MLW)
Value	lowestLowWaterSprings		6		
Value	approximateMeanLowWaterSprings		7		
Value	indianSpringLowWater		8		
Value	lowWaterSprings		9		
Value	approximateLowestAstronomicalTide		10		
Value	nearlyLowestLowWater		11		
Value	meanLowerLowWater		12		(MLLW)
Value	lowWater		13		(LW)
Value	approximateMeanLowWater		14		
Value	approximateMeanLowerLowWater		15		
Value	meanHighWater		16		(MHW)
Value	meanHighWaterSprings		17		(MHWS)
Value	highWater		18		(HW)
Value	approximateMeanSeaLevel		19		
Value	highWaterSprings		20		

Role Name	Name	Description	Code	Type	Remarks
Value	meanHigherHighWater		21		(MHHW)
Value	equinoctialSpringLowWater		22		
Value	lowestAstronomicalTide		23		(LAT)
Value	localDatum		24		
Value	internationalGreatLakesDatum1985		25		
Value	meanWaterLevel		26		
Value	lowerLowWaterLargeTide		27		
Value	higherHighWaterLargeTide		28		
Value	nearlyHighestHighWater		29		
Value	highestAstronomicalTide		30		(HAT)

Note: The numeric codes are the codes specified in the IHO GI Registry for the equivalent listed values of the IHO Hydro domain attribute *Vertical datum*, since the registry does not at present (20 June 2018) contain entries for exchange set metadata and dataset metadata attributes.

12.7.5 S100_DataFormat

S-102 uses S100_DataFormat with a restriction on the allowed values to permit only the S-100 HDF5 format for S-102 datasets.

Role Name	Name	Description	Code	Type	Remarks
Enumeration	S100_DataFormat	The encoding format	-	-	The only value allowed in S-102 is "HDF5"
Value	HDF5	The HDF5 data format as defined in S-100 Part 10c			

12.7.6 S100_ProductSpecification

S-102 uses S100_ProductSpecification without modification. The Product Specification attributes encoded must obviously be for this edition of S-102.

Role name	Name	Description	Mult	Type	Remarks
Class	S100_ProductSpecification	The Product Specification contains the information needed to build the specified product	-	-	-
Attribute	name	The name of the Product Specification used to create the datasets	1	CharacterString	
Attribute	version	The version number of the Product Specification	1	CharacterString	
Attribute	date	The version date of the Product Specification	1	Date	
Attribute	number	The number (registry index) used to lookup the product in the Product Specification Register of the IHO GI registry	1	Integer	From the Product Specification Register, in the IHO Geospatial Information Registry

12.7.7 S100_ProtectionScheme

Role Name	Name	Description	Code	Type	Remarks
Enumeration	S100_ProtectionScheme	Data protection schemes	-	-	-
Value	S100p154.0.0	S-100 4.0.0 Part 15	-	-	See S-100 Part 15. (Note: The specified value corrects a discrepancy between S-100 4.0.0 Figure 4a-D-4 and the table S100_ProtectionScheme in S-100 Part 4a-D.)

12.7.8 S102_GriddingMethod

Role Name	Name	Description	Code	Type	Remarks
Enumeration	S102_GriddingMethod	Gridding methods	-	-	-
Value	basicWeightedMean	The Basic Weighted Mean algorithm computes an average depth for each grid node. Contributing depth estimates within a given area of influence are weighted and averaged to compute the final nodal value	1	-	

Role Name	Name	Description	Code	Type	Remarks
Value	shoalestDepth	The Shoalest Depth algorithm examines depth estimates within a specific area of influence and assigns the shoalest value to the nodal position. The resulting surface represents the shallowest depths across a given area	2	-	
Value	tpuWeightedMean	The Total Propagated Uncertainty (TPU) Weighted Mean algorithm makes use of the depth and associated total propagated uncertainty for each contributing depth estimate to compute a weighted average depth for each nodal position	3	-	TPU is a measure of the expected accuracy of the depth estimate when all relevant error/uncertainty sources have been considered.
Value	cube	The Combined Uncertainty and Bathymetric Estimator, or CUBE makes use of the depth and associated total propagated uncertainty for each contributing depth estimate to compute one or many hypotheses for an area of interest. The resulting hypotheses are used to estimate statistical representative depths at each nodal position	4	-	
Value	nearestNeighbour	The Nearest Neighbour algorithm identifies the nearest depth value within an area of interest and assigns that value to the nodal position. This method does not consider values from neighbouring points	5	-	
Value	naturalNeighbour	Natural Neighbour interpolation identifies and weights a subset of input samples within the area of interest to interpolate the final nodal value	6	-	
Value	polynomialTendency	The Polynomial Tendency gridding method attempts to fit a polynomial trend, or best fit surface to a set of input data points. This method can project trends into areas with little to no data, but does not work well when there is no discernible trend within the data set	7	-	
Value	spline	The Spline algorithm estimates nodal depths using a mathematical function to minimize overall surface curvature. The final "smoothed" surface passes exactly through the contributing input depth estimates	8	-	

Role Name	Name	Description	Code	Type	Remarks
Value	kriging	Kriging is a geostatistical interpolation method that generates an estimated surface from a scattered set of points with a known depth	9	-	

12.8 S102_CatalogueMetadata

The class S102_CatalogueMetadata is realized from S100_CatalogueMetadata without modification. The S-102 class is defined in order to act as a proxy for the corresponding S-100 generic class in S-102 UML diagrams of exchange set structure.

Role name	Name	Description	Mult	Type	Remarks
Class	S102_CatalogueMetadata	Class for S-102 catalogue metadata	-	-	-
Attribute	filename	The name for the catalogue	1..*	CharacterString	
Attribute	fileLocation	Full location from the exchange set root director	1..*	CharacterString	Path relative to the root directory of the exchange set. The location of the file after the exchange set is unpacked into directory <EXCH_ROOT> will be <EXCH_ROOT>/<filePath>/<filename>
Attribute	scope	Subject domain of the catalogue	1..*	S100_CatalogueScope	
Attribute	versionNumber	The version number of the product specification	1..*	CharacterString	
Attribute	issueDate	The version date of the product specification	1..*	Date	
Attribute	productSpecification	The product specification used to create this file	1..*	S100_ProductSpecification	
Attribute	digitalSignatureReference	Digital Signature of the file	1	S100_DigitalSignature	Reference to the appropriate digital signature algorithm
Attribute	digitalSignatureValue	Value derived from the digital signature	1	S100_DigitalSignatureValue	The value resulting from application of digitalSignatureReference Implemented as the digital signature format specified in Part 15
Attribute	defaultLocale	Default language and character set used in the exchange catalogue	1	PT_Locale	

Attribute	otherLocale	Other languages and character sets used in the exchange catalogue	0..*	PT_Locale	
-----------	-------------	---	------	-----------	--

12.8.1 S100_CatalogueScope

S-102 uses S100_CatalogueScope without modification.

Role Name	Name	Description	Code	Type	Remarks
Enumeration	S100_CatalogueScope	The scope of the catalogue	-	-	-
Value	featureCatalogue	S-100 feature catalogue			
Value	portrayalCatalogue	S-100 portrayal catalogue			
Value	interoperabilityCatalogue	S-100 interoperability information			

12.8.2 PT_Locale

Role name	Name	Description	Mult	Type	Remarks
Class	PT_Locale	Description of a locale	-	-	From ISO 19115-1
Attribute	language	Designation of the locale language	1	LanguageCode	ISO 639-2 3-letter language codes.
Attribute	country	Designation of the specific country of the locale language	0..1	CountryCode	ISO 3166-2 2-letter country codes
Attribute	characterEncoding	Designation of the character set to be used to encode the textual value of the locale	1	MD_CharacterSetCode	Use (the "Name" from the) IANA Character Set register: http://www.iana.org/assignments/character-sets . (ISO 19115-1 B.3.14) For example, UTF-8

The class PT_Locale is defined in ISO 19115-1. LanguageCode, CountryCode, and MD_CharacterSetCode are ISO codelists which should either be defined in resource files and encoded as (string) codes, or represented by the corresponding literals from the namespaces identified in the Remarks column.

Annex A. Data Classification and Encoding Guide

A-1 Features

BathymetryCoverage

A set of value items required to define a dataset representing a depth calculation and its associated uncertainty			
Primitive: S-100_Grid_Coverage			
Attribute	Allowable Encoding Value	Type	Multiplicity
depth	Must be in decimal metres with precision not to exceed 0.01 metres	real	1
uncertainty	Must be in decimal metres with precision not to exceed 0.01 metres	real	1..*

TrackingListCoverage

A set of value items required to define a dataset representing a series of overrides to the associated S102 Grid			
Primitive: S-100_PointSet			
Attribute	Allowable Encoding Value	Type	Multiplicity
X	Must be an integer expressing a column of the associated 2D BathymetryCoverage dataset	integer	1
Y	Must be an integer expressing a row of the associated 2D BathymetryCoverage dataset	integer	1
original value	Must be in decimal metres with precision not to exceed 0.01 metres	real	1
track code	Must be an integer expressing a valid enumeration value defining the reason a modification was made at this grid location	integer	1
list series	Must be an integer expressing a value defining the index location in the metadata defining the modification	integer	1

A-2 Feature Attributes

BathymetryCoverage

depth: IHO Definition: DEPTH; The vertical distance from a given water level to the bottom [IHO S-32]
<u>Unit:</u> metres
<u>Resolution:</u> 0.01
<u>Remarks:</u>
<ul style="list-style-type: none"> For S-102 the sign convention is for z to be positive for values above the vertical datum
uncertainty: IHO Definition: UNCERTAINTY; The interval (about a given value) that will contain the true value of the measurement at a specific confidence level [IHO S44]
<u>Unit:</u> metres
<u>Resolution:</u> 0.01
<u>Remarks:</u>
<ul style="list-style-type: none"> Represents a +/- value defining the possible range of associated depth Expressed a positive number

TrackingListCoverage

X: IHO Definition: GRID POINT; point located at the intersection of two or more curves in a grid [ISO 19123]
<u>Unit:</u> column
<u>Resolution:</u> N/A
<u>Remarks:</u>
<ul style="list-style-type: none"> Bound by <i>numPointsLongitudinal</i> (S100 Part 10c)
Y: IHO Definition: GRID POINT; point located at the intersection of two or more curves in a grid [ISO 19123]
<u>Unit:</u> row
<u>Resolution:</u> N/A
<u>Remarks:</u>
<ul style="list-style-type: none"> Bound by <i>numPointsLatitudinal</i> (S100 Part 10c)
original value: IHO Definition: DEPTH; The vertical distance from a given water level to the bottom [IHO S-32]
<u>Unit:</u> metres
<u>Resolution:</u> 0.01

<u>Remarks:</u> <ul style="list-style-type: none">• For S-102 the sign convention is for z to be positive for values above the vertical datum
track code: IHO Definition: value indicating why a modification was made to the depth value
<u>Unit:</u> ENUM
<u>Resolution:</u> N/A
list series: IHO Definition: value indicating the index location within the metadata defining the modification
<u>Unit:</u> N/A
<u>Resolution:</u> N/A

Page intentionally left blank

Annex B. HDF-5 Encoding

This example of the HDF-5 encoding is based on the structures and requirements defined in S-100 v4.0.0, PART 10C.

B-1 General Structure

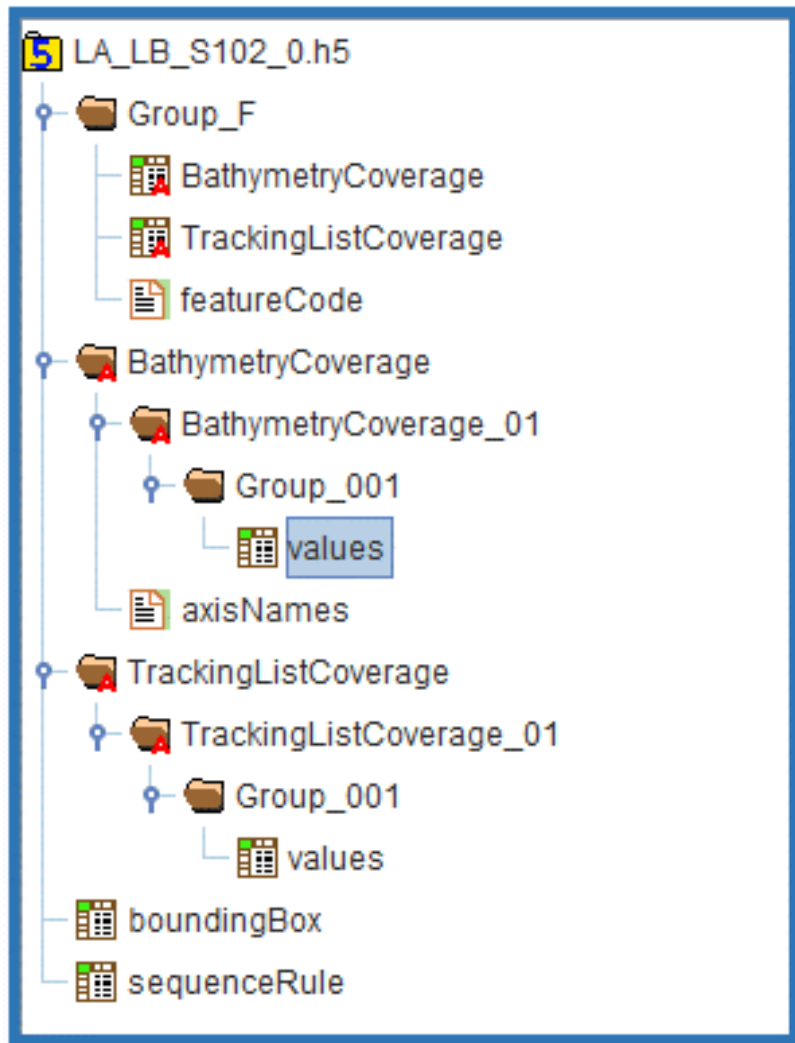

Figure B.1 - S-102 Encoding

B-1.1 BathymetryCoverage

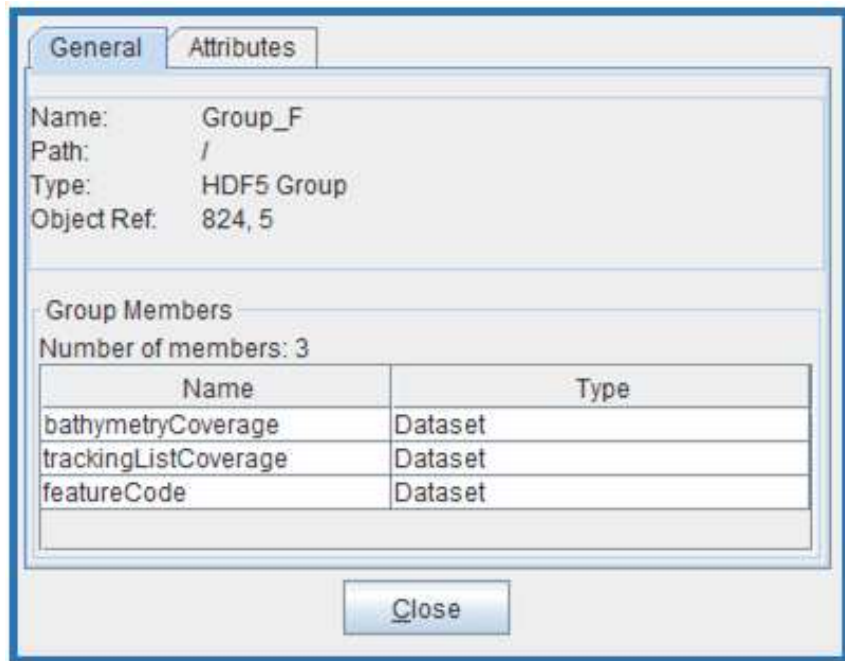

Figure B.2 - S-102 Group_F Encoding general structure.



Figure B.3 - S-102 Group_F/featureCode Encoding general structure.

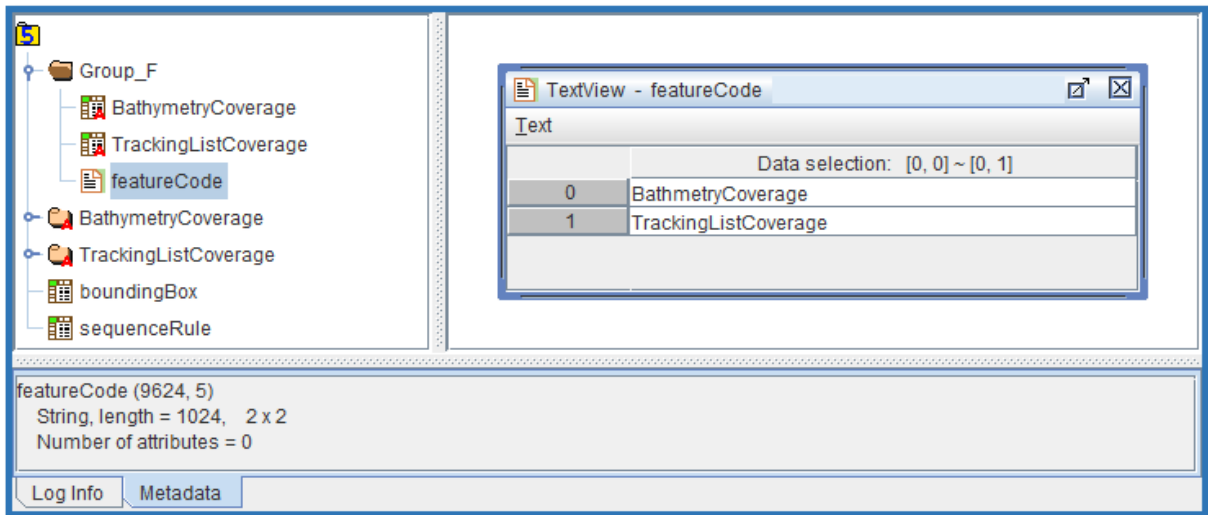

Figure B.4 - S-102 Group_F/featureCode Encoding dataset values

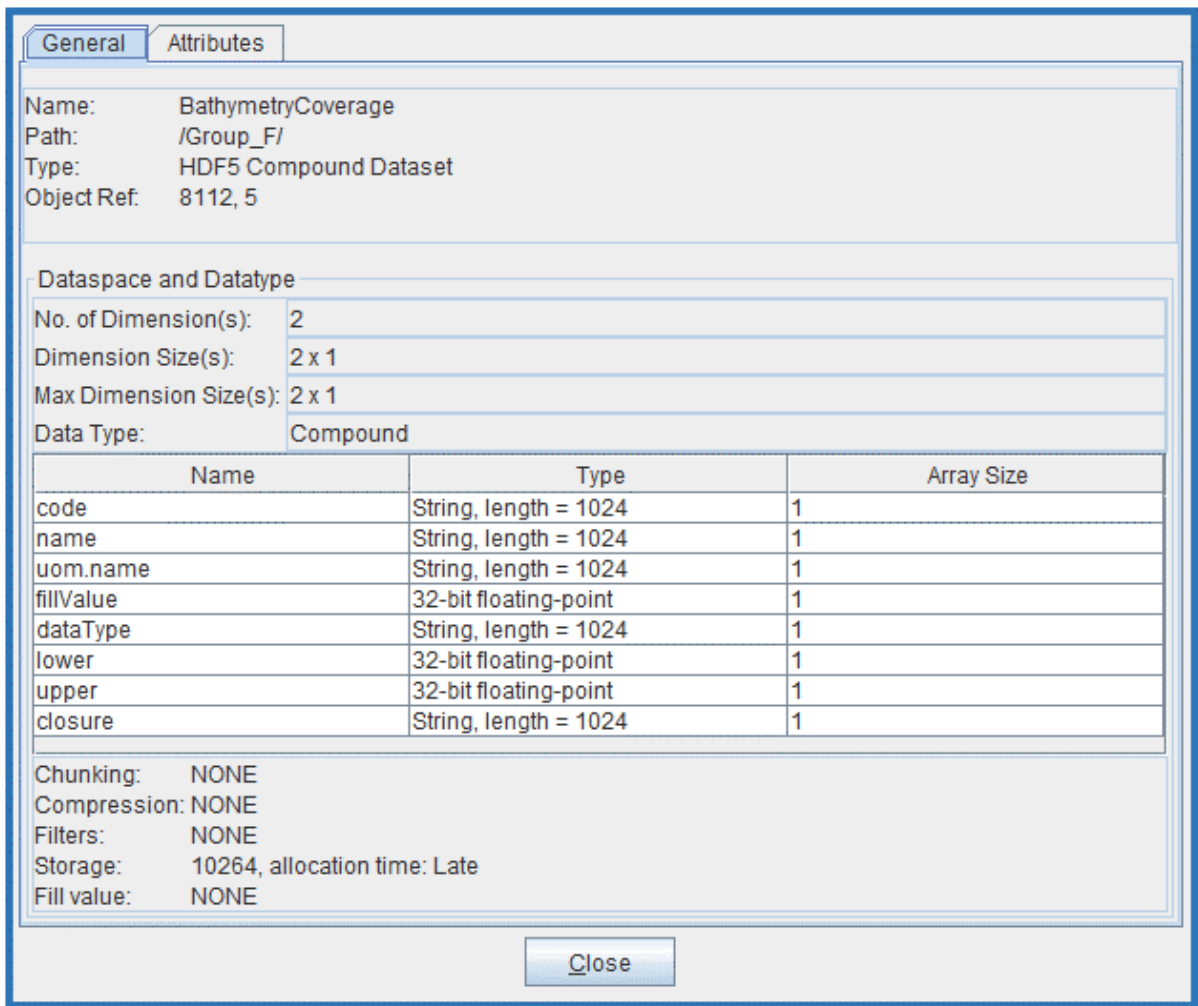

Figure B.5 - S-102 Encoding Group_F/BathymetryCoverage Encoding general structure

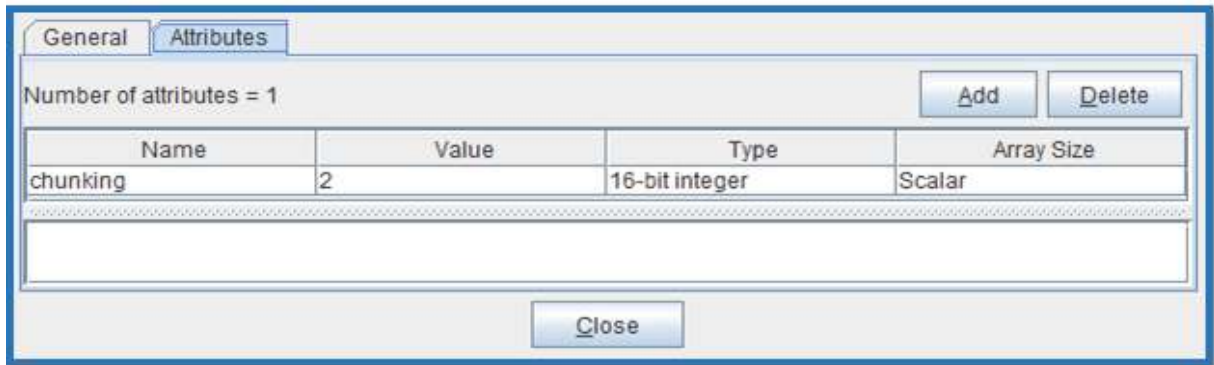

Figure B.6 - S-102 Encoding Group_F/BathymetryCoverage Encoding attributes.

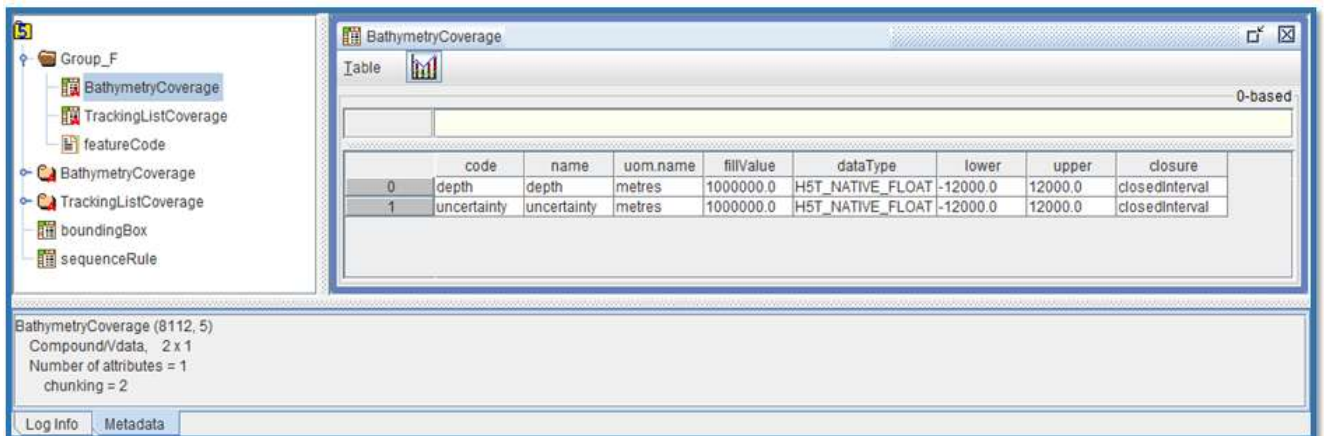

Figure B.7 - S-102 Encoding Group_F/BathymetryCoverage Encoding dataset values

General | Attributes

Name: TrackingListCoverage
 Path: /Group_F/
 Type: HDF5 Compound Dataset
 Object Ref: 9032, 5

Dataspace and Datatype

No. of Dimension(s): 2
 Dimension Size(s): 5 x 1
 Max Dimension Size(s): 5 x 1
 Data Type: Compound

Name	Type	Array Size
code	String, length = 1024	1
name	String, length = 1024	1
uom.name	String, length = 1024	1
fillValue	32-bit floating-point	1
dataType	String, length = 1024	1
lower	32-bit floating-point	1
upper	32-bit floating-point	1
closure	String, length = 1024	1

Chunking: NONE
 Compression: NONE
 Filters: NONE
 Storage: 25660, allocation time: Late
 Fill value: NONE

Close

Figure B.8 - S-102 Encoding Group_F/TrackingListCoverage Encoding (top) general structure

TrackingListCoverage

Table

0-based

	code	name	uom.name	fillValue	dataType	lower	upper	closure
0	X	X	N/A	0.0	H5T_NATIVE_INT	0.0	1000000.0	closedInterval
1	Y	Y	N/A	0.0	H5T_NATIVE_INT	0.0	1000000.0	closedInterval
2	originalValue	Original Value	metres	0.0	H5T_NATIVE_FLOAT	-12000.0	12000.0	closedInterval
3	trackCode	Track Code	N/A	0.0	H5T_NATIVE_INT	0.0	1000000.0	closedInterval
4	listSeries	List Series	N/A	0.0	H5T_NATIVE_INT	0.0	1000000.0	closedInterval

TrackingListCoverage (9032, 5)
 Compound/Vdata, 5 x 1
 Number of attributes = 1
 chunking = 1

Log Info | Metadata

Figure B.9 - S-102 Encoding Group_F/TrackingListCoverage Encoding dataset values

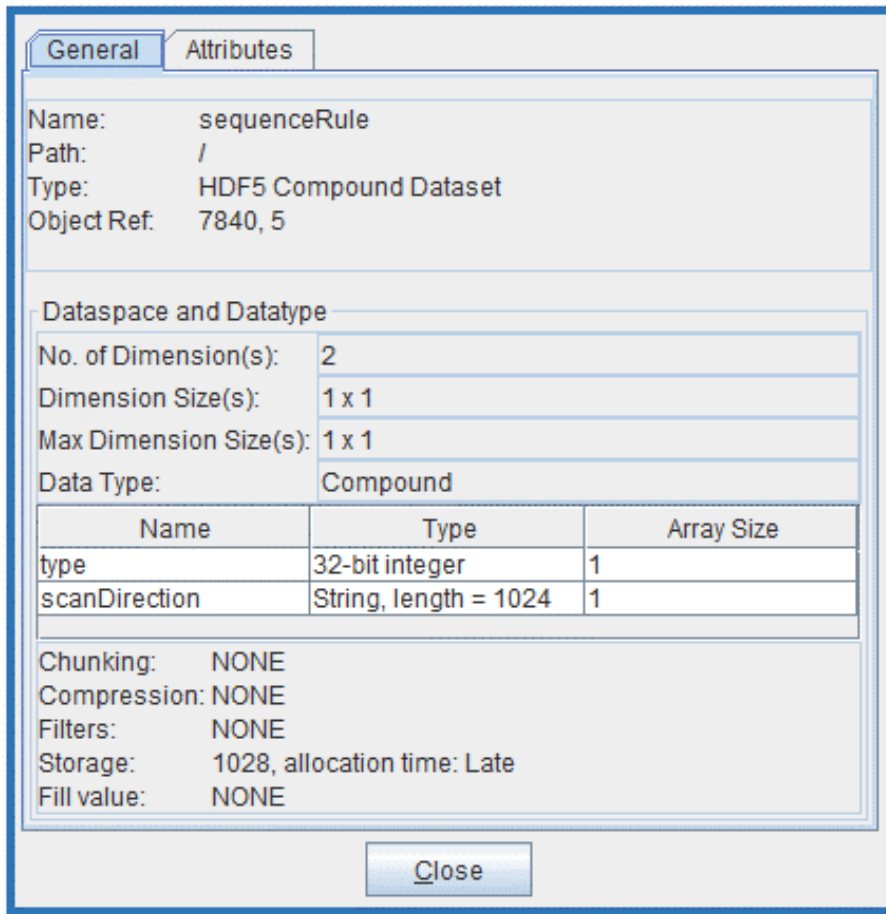

Figure B.10 - S-102 Encoding sequenceRule Encoding general structure

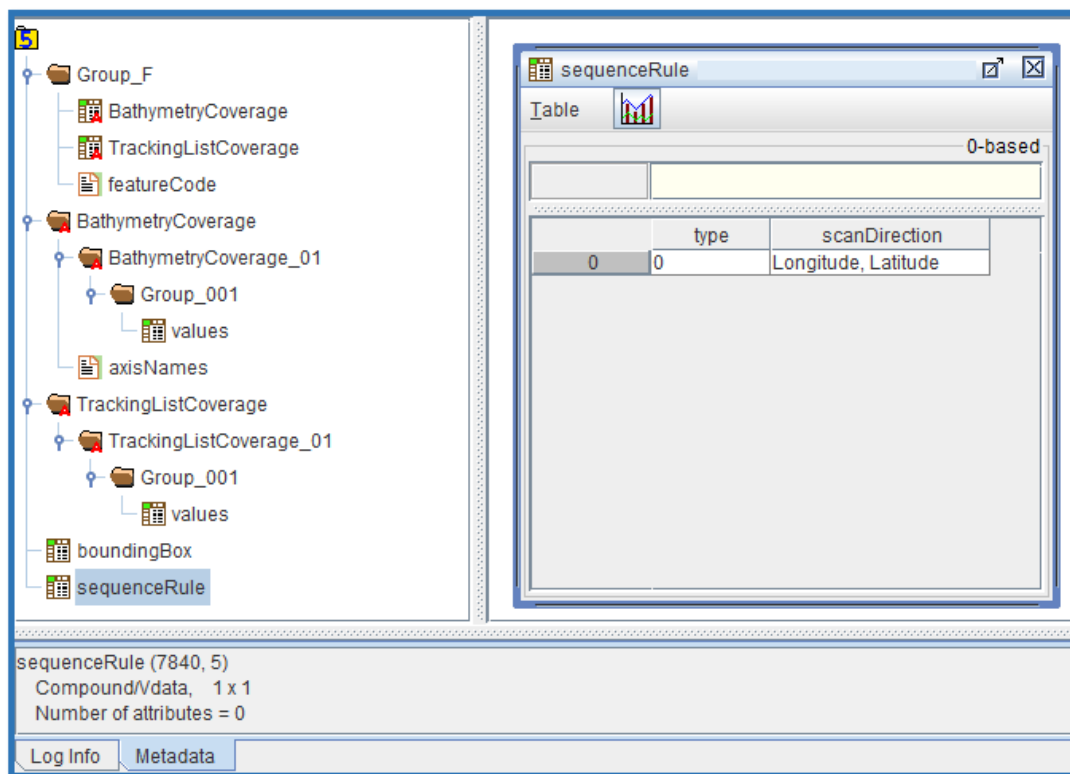

Figure B.11 - S-102 Encoding sequenceRule Encoding dataset values

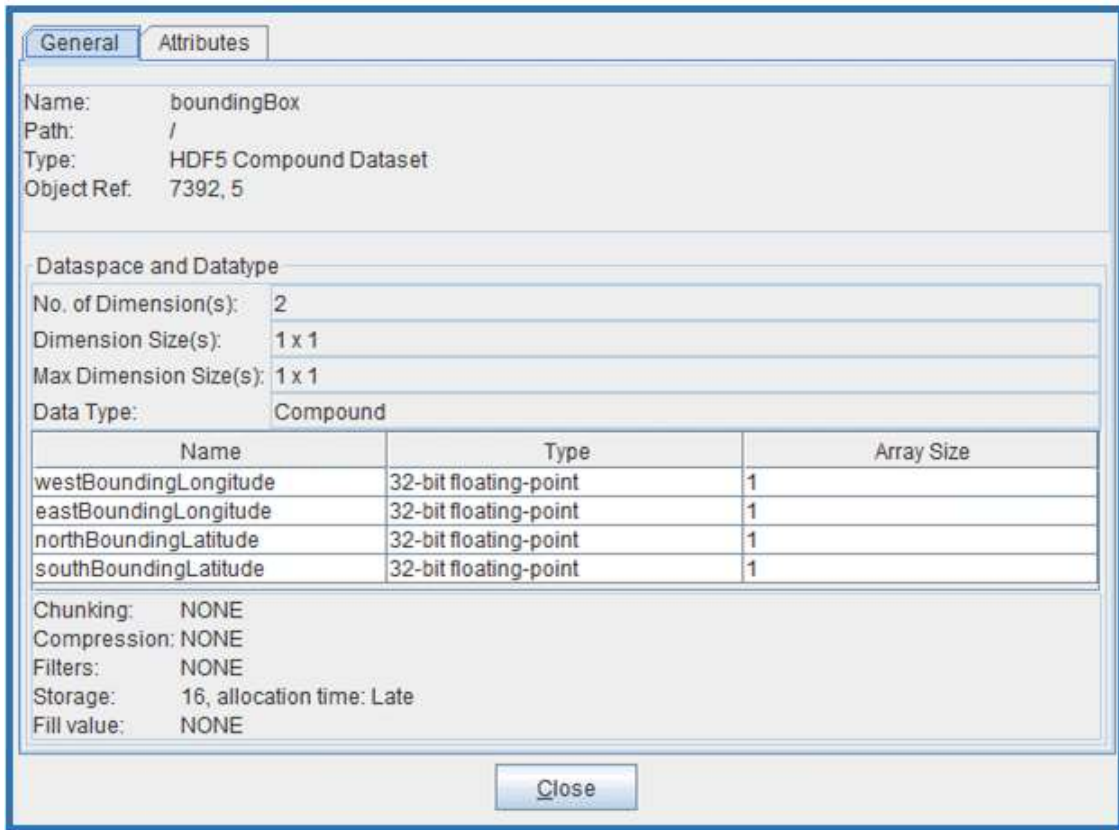

Figure B.12 - S-102 Encoding boundingBox Encoding general structure

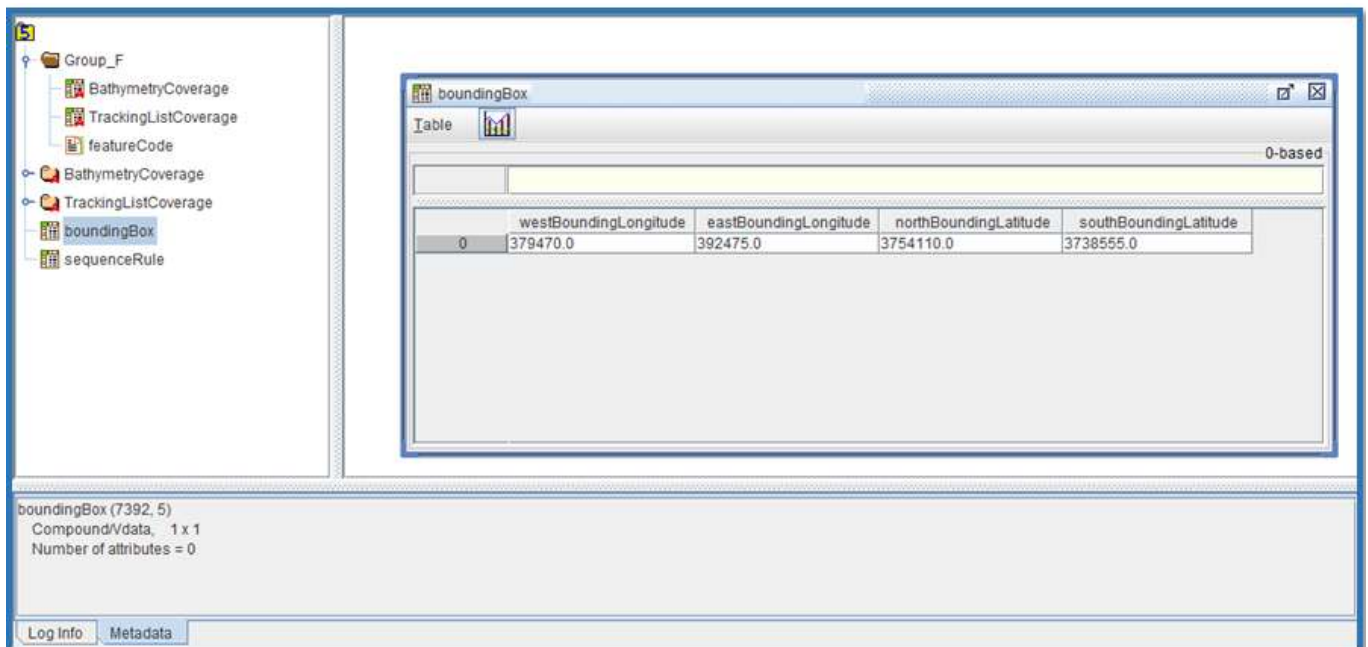

Figure B.13 - S-102 Encoding boundingBox Encoding dataset values

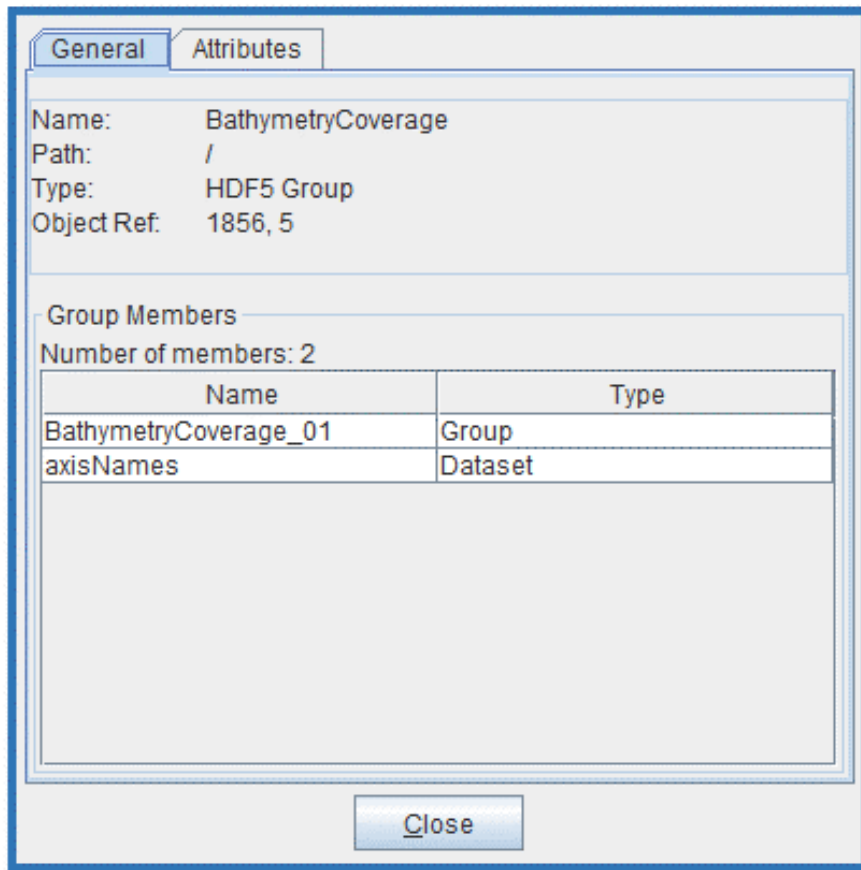

Figure B.14 - S-102 Encoding BathymetryCoverage Encoding general

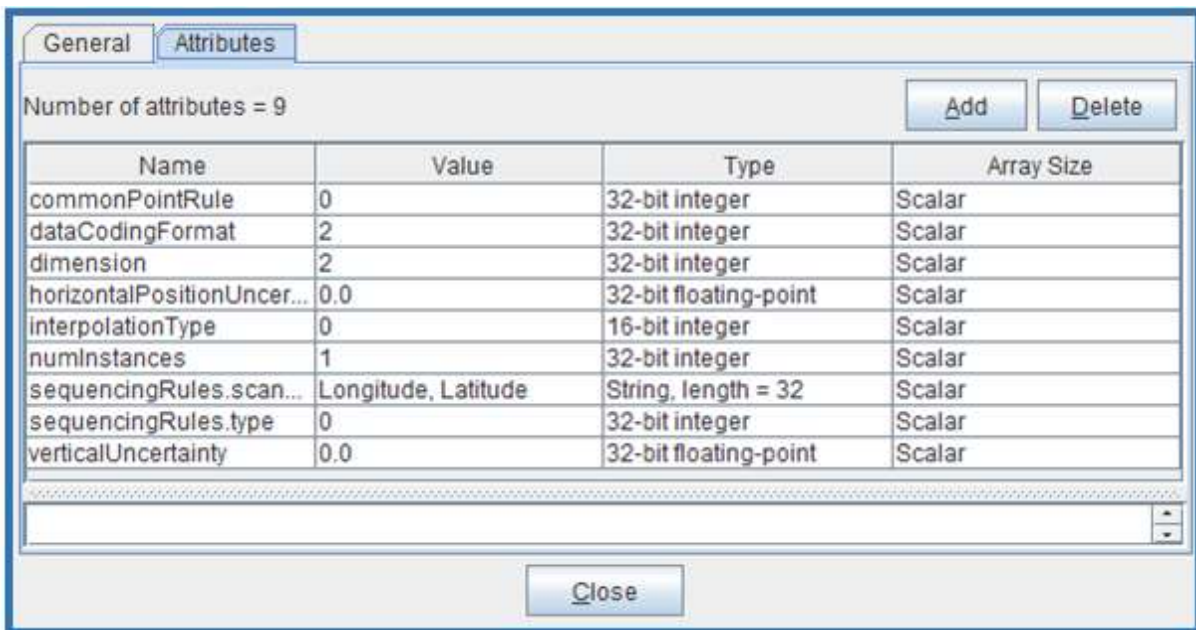

Figure B.15 - S-102 Encoding BathymetryCoverage Encoding attributes

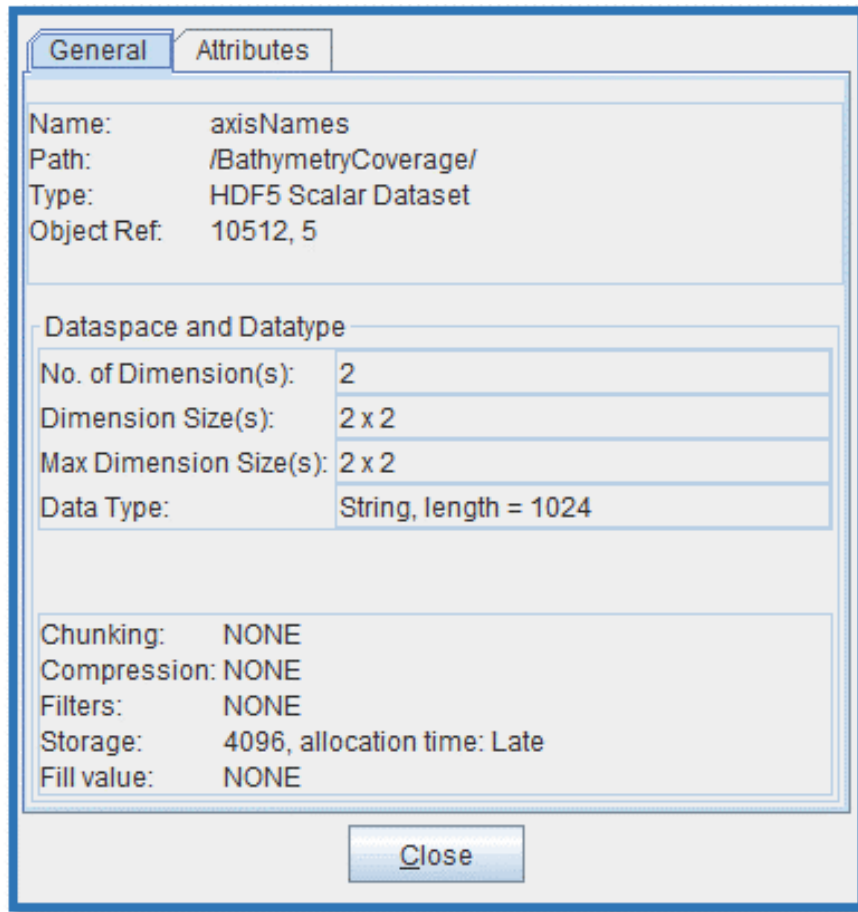

Figure B.16 - S-102 Encoding BathymetryCoverage/axisNames Encoding general structure

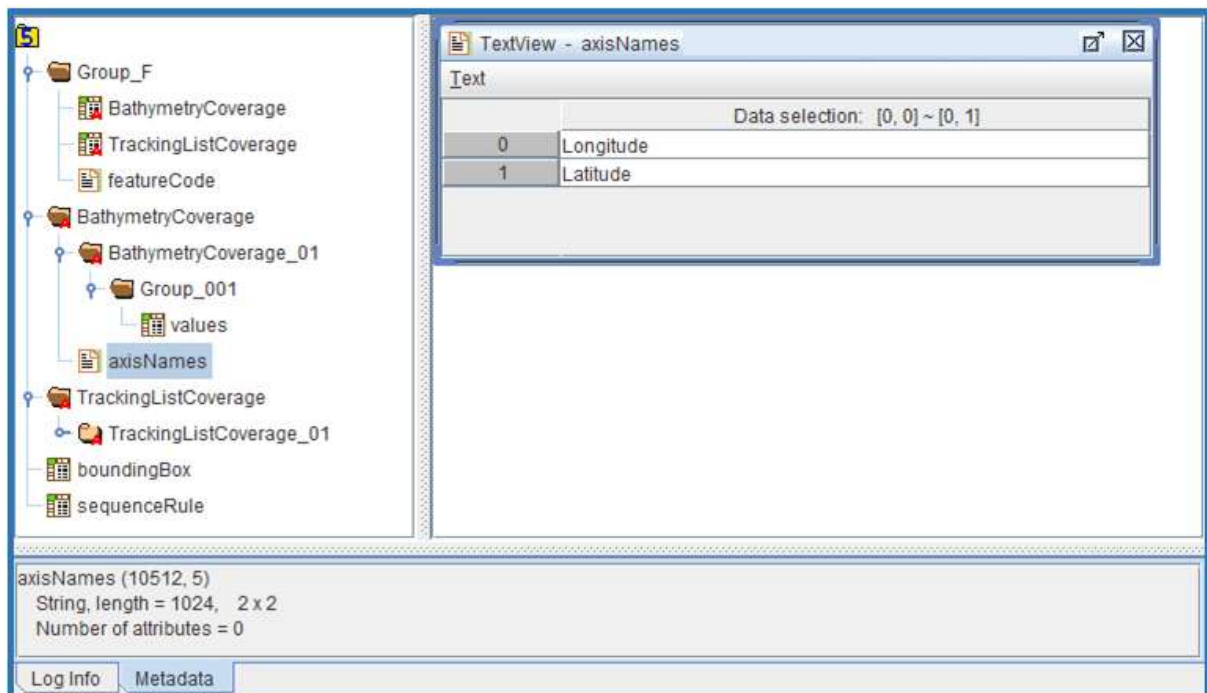

Figure B.17 - S-102 Encoding BathymetryCoverage/axisNames Encoding dataset values

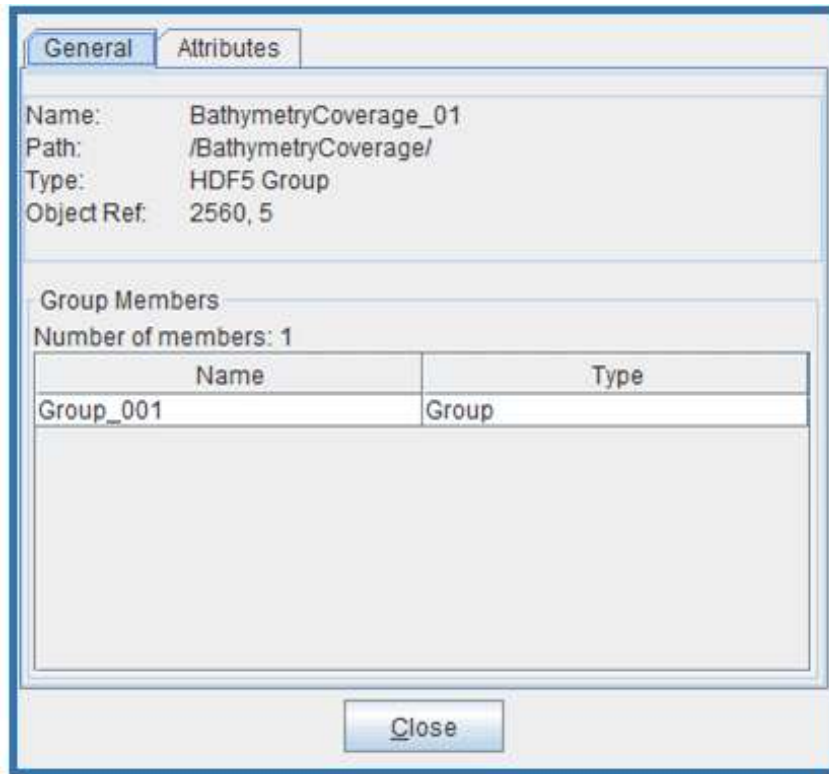

Figure B.18 - S-102 Encoding BathymetryCoverage/BathymetryCoverage_01 Encoding general structure

General Attributes

Number of attributes = 16

Name	Value	Type	Array Size
boundingBox.eastBoundLo...	392475.0	32-bit floating-point	Scalar
boundingBox.northBoundL...	3754110.0	32-bit floating-point	Scalar
boundingBox.southBoundL...	3738555.0	32-bit floating-point	Scalar
boundingBox.westBoundL...	379470.0	32-bit floating-point	Scalar
gridOriginLatitude	392475.0	32-bit floating-point	Scalar
gridOriginLongitude	379470.0	32-bit floating-point	Scalar
gridSpacingLatitudal	5.0	32-bit floating-point	Scalar
gridSpacingLongitudal	5.0	32-bit floating-point	Scalar
minGridPointLatitudal	0	32-bit integer	Scalar
minGridPointLongitudal	0	32-bit integer	Scalar
minGridPointVertical	0	32-bit integer	Scalar
numGrp	1	16-bit integer	Scalar
numPointLongitudal	2601	32-bit integer	Scalar
numPointsLatitudal	3111	32-bit integer	Scalar
numPointsVertical	0	32-bit integer	Scalar
startSequence	0,0	String, length = 32	Scalar

Close

Figure B.19 - S-102 Encoding BathymetryCoverage/BathymetryCoverage_01 Encoding attributes

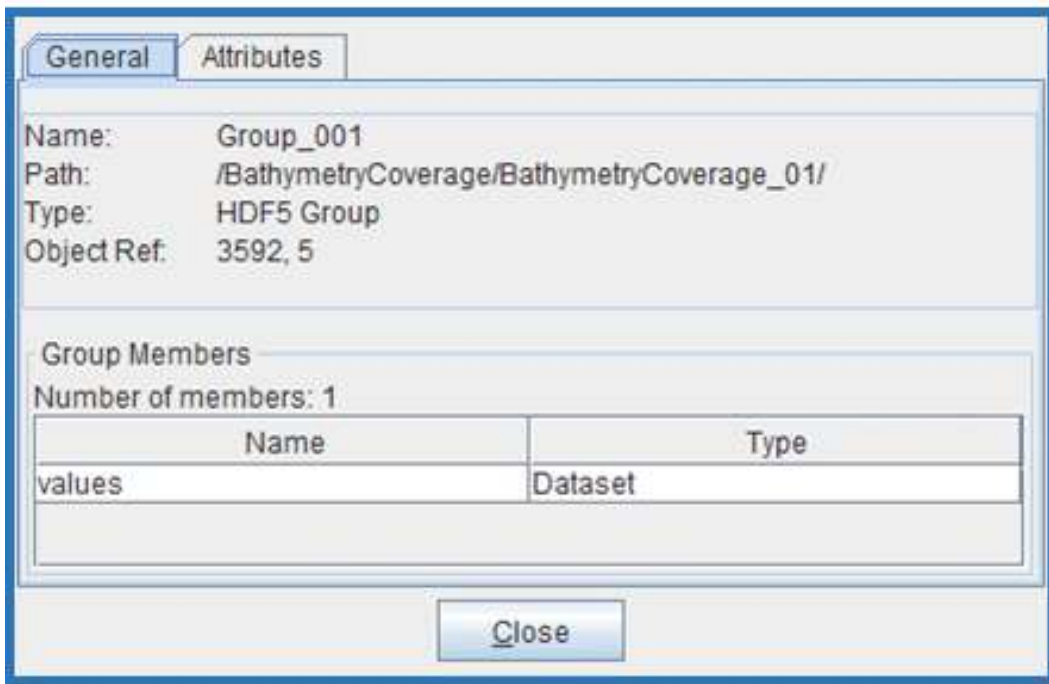

Figure B.20 - S-102 Encoding BathymetryCoverage/BathymetryCoverage_01/Group_001 Encoding general structure

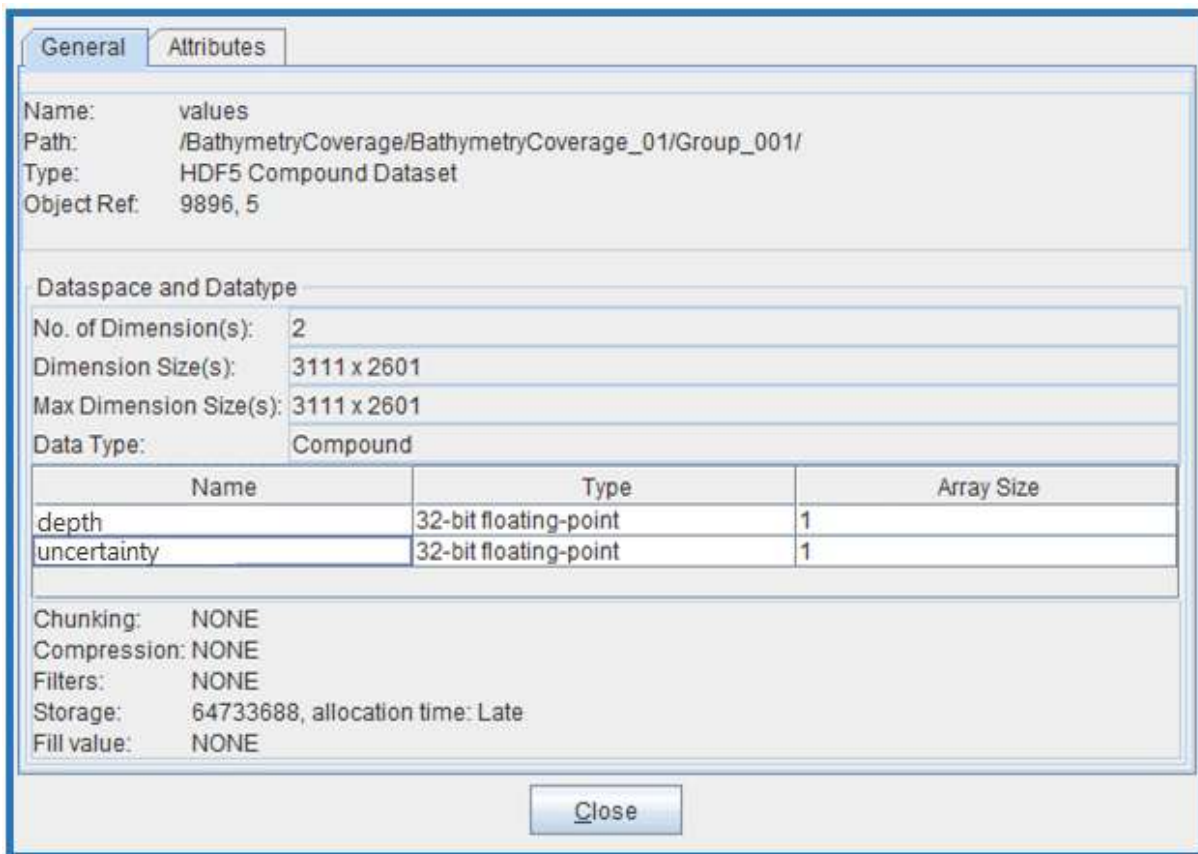

Figure B.21 - S-102 Encoding BathymetryCoverage/BathymetryCoverage_01/Group_001/values Encoding general structure.

	depth	950 uncertainty	depth	951 uncertainty	depth	952 unc
2726	-16.47	-0.16469999	-16.83	-0.1683	-16.71	-0.16
2727	-16.81	-0.1681	-16.63	-0.1663	-16.47	-0.16
2728	-16.5	-0.165	-16.92	-0.1692	-16.48	-0.16
2729	-15.66	-0.1566	-16.77	-0.16770001	-16.79	-0.16
2730	-13.76	-0.1376	-13.98	-0.1398	-15.63	-0.15
2731	-13.2	-0.132	-13.66	-0.1366	-13.7	-0.13
2732	-11.36	-0.11359999	-12.52	-0.1252	-13.04	-0.13
2733	-9.33	-0.0933	-10.15	-0.1015	-10.76	-0.10
2734	-8.18	-0.08180001	-9.0	-0.09	-9.46	-0.09

values (9896, 5)
Compound/Vdata, 3111 x 2601
Number of attributes = 0

Log Info Metadata

Figure B.22 - S-102 Encoding BathymetryCoverage/BathymetryCoverage_01/Group_001/values Encoding dataset values

B-1.2 TrackingListCoverage

The exact encoding of the S102_TracklingListCoverage based on the S100 Part 10c structure is still being developed.

Annex C. Normative Implementation Guidance

Normative Implementation Guidance to be addressed in a future version of S-102.

Page intentionally left blank

Annex D. Feature Catalogue

S-102 Feature Catalogue information is contained within a separate document: S-102FC_Ed2.0.0.docx.

Page intentionally left blank

Annex E. Portrayal Catalogue

Portrayal Catalogue currently under development.

Page intentionally left blank

Annex F. S-102 Dataset Size and Production

F-1 Header Record

An S-102 file will contain two header sections. The first section contains, at minimum, the mandatory metadata elements as defined in Part 4 of the S-100 specification. The second section contains, at minimum, the mandatory metadata elements as defined in Section 12 of the S-102 specification. The producers may add optionally defined metadata to these sections, as their processes/standards require.

Given that the contents of these metadata attributes will vary between producers, it is impossible to define a definitive size for the file header. The estimated maximum size for the full header of an S-102 file is 3 MB. This is an estimate based on the expected encoding of mandatory metadata in both S-100/S-102, usage of the optional metadata elements and expected verbosity of those elements.

F-2 Data Records/Nodes

The data contained within an S-102 file consists of two distinct data types. The first layer is the **TrackingListCoverage** and is defined as a single dimensional array of nodes. Each of the nodes, within this array, contains five data values. The first and last two values in the array are stored as a 4-byte integers the remaining value is stored as a 4-byte floating point. The total size of each node with therefore is 20 bytes.

The second layer is the **BathymetryCoverage** and is defined as a two-dimensional array of nodes containing bathymetric data. Each of the nodes within this array contains two data values (depth and uncertainty). Both values are stored as a 4-byte floating point. The total size of each node will therefore be 8 bytes.

The size of each of these arrays is independent of the other. The number of elements in a tracking list will vary significantly between geographic areas. A worst-case estimate of the overall number of entries is 100,000. This number is several orders of magnitude greater than is reasonable expected and results in an estimated total size of 1 Mb.

F-3 File Estimates

Table F.1 estimates the possible number of records for a given S-102 file. This estimation is based on file size constraints and the estimates described above. Rounded to the nearest hundred, this estimate allows us to state that a file not exceeding 5700x5700 nodes will remain below the 256 MB, and a file not exceeding 600x600 will remain below the 10 MB. Figures F.1 and F.2 depict maximum grid size for 10MB and 256MB.

Table F.1 - Calculated File Size for 10 MB and 256 MB (Uncompressed Dataset)

BathymetryCoverage			TrackingListCoverage		
Records			Records		
Name	Type	Size	Name	Type	Size
depth	Float	4	X	Integer	4
uncertainty	Float	4	Y	Integer	4
			originalValue	Float	4

				trackCode	Integer	4
				listSeries	Integer	4
	Total Size	8			Total Size	20
Sizes (bytes)						
KB	MB		GB			
1,024	1,048,576		1,073,741,824			
File Options						
Max Size Options (MB)	256		10			
Header Size (MB)	3		3			
TrackingListCoverage Size						
Worst Case Estimate of Entries	50,000		50,000			
TrackingListCoverage Size (MB)	<1		<1			
BathymetryCoverage Size						
BathymetryCoverage Size(MB)	253		7			
Total Number of BathymetryCoverage Records	33,160,966		366,902			
Square Dimensions (BathymetryCoverage)	5,759		606			

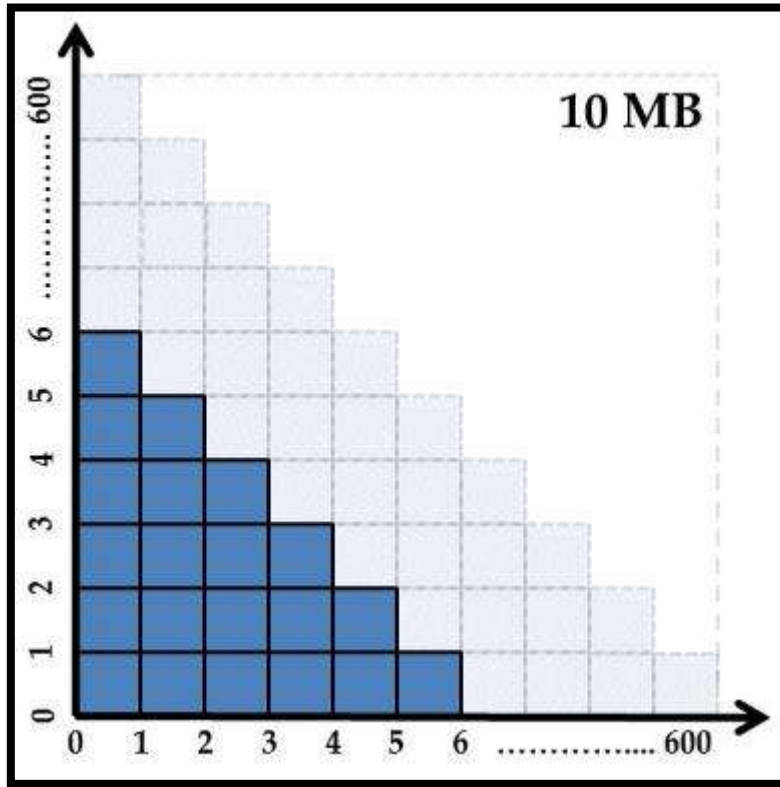

Figure F.1 - Informative grid extents for a 10 MB Uncompressed Dataset

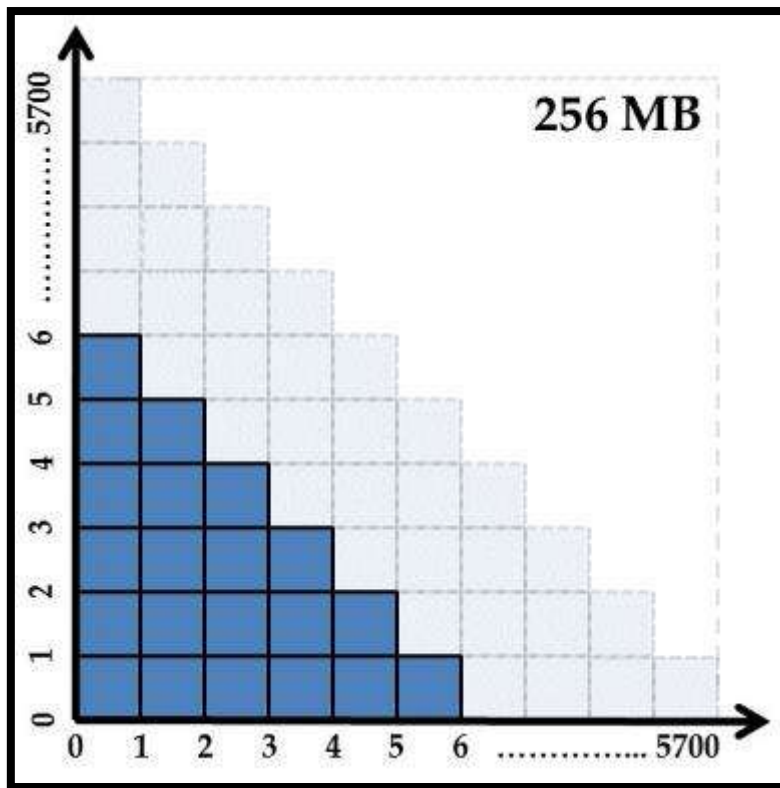

Figure F.2 - Informative grid extents for a 256 MB Uncompressed Dataset

Page intentionally left blank

Annex G. S-102 Gridding Methods

- The **Basic Weighted Mean** algorithm computes an average depth for each grid node. Contributing depth estimates within a given area of influence are weighted and averaged to compute the final nodal value.
- The **Shoalest Depth** algorithm examines depth estimates within a specific area of influence and assigns the shoalest value to the nodal position. The resulting surface represents the shallowest depths across a given area.
- The **Total Propagated Uncertainty (TPU) Weighted Mean** algorithm makes use of the depth and associated total propagated uncertainty for each contributing depth estimate to compute a weighted average depth for each nodal position.
- *Note: TPU is a measure of the expected accuracy of the depth estimate when all relevant error/uncertainty sources have been considered.*
- The **Combined Uncertainty and Bathymetric Estimator, or CUBE** makes use of the depth and associated total propagated uncertainty for each contributing depth estimate to compute one or many hypotheses for an area of interest. The resulting hypotheses are used to estimate statistical representative depths at each nodal position.
- The **Nearest Neighbour** algorithm identifies the nearest depth value within an area of interest and assigns that value to the nodal position. This method does not consider values from neighbouring points.
- **Natural Neighbour** interpolation identifies and weights a subset of input samples within the area of interest to interpolate the final nodal value.
- The **Polynomial Tendency** gridding method attempts to fit a polynomial trend, or best fit surface to a set of input data points. This method can project trends into areas with little to no data, but does not work well when there is no discernible trend within the data set.
- The **Spline** algorithm estimates nodal depths using a mathematical function to minimize overall surface curvature. The final “smoothed” surface passes exactly through the contributing input depth estimates.
- **Kriging** is a geostatistical interpolation method that generates an estimated surface from a scattered set of points with a known depth.

Page intentionally left blank

Annex H. Multi-Resolution Gridding

Multi-Resolution gridding to be addressed in a future version of S-102.

Page intentionally left blank

Annex I. Gridding Full Resolution Source Bathymetry and its Relationship to a Charted Sounding

I-1 Modern High-Resolution Hydrographic Multibeam Sonars

As stated in clause 9, the majority of modern hydrographic surveys are conducted using high-resolution multibeam sonar systems. These systems provide great target detection capability and allow for the production of highly detailed images of the seafloor. It must be understood that this capability comes at a price. These systems collect a tremendous amount of information which requires sufficient processing power and data storage to reduce an overwhelming quantity of depth estimates to a manageable number for charting production. The following example describes one method to grid high-resolution multibeam sonar data. This example additionally shows the relationship of a product scale grid to the actual charted sounding.

I-1.1 Example Collection Scenario

Environmental Characteristics Relatively Flat Seafloor
Average Water Depth: 20 metres

Charting Parameters
Intended charting scale: 1:22,000

Survey Plan
Survey Length: 30 days
Daily Collection Window: 12 hours each day Collection Speed: 8 kts.

Collection Sonar Characteristics
Sonar Frequency: 400kHz
Beam Width: 0.5° X 0.5°
Number of Beams Across Swath: 400 soundings per ping
Swath Coverage: 5 times water depth
Sonar Max Ping Rate: 20 Hz

I-2 Survey Metrics

I-2.1 Ping Rate and Number of Depth Estimates

In 20 metres of water the system described above would collect 400 individual depth estimates each ping. If maximum ping rate of 20 Hz is realized the sonar has the ability to collect 8000 individual depth estimates every second.

400 depth estimates per ping X 20 Hz = 8000 depth estimates / second

-OR-

28.8 million depth estimates each hour.
345.6 million depth estimates every day.
10.4 billion depth estimates at the end of the survey.

I-2.2 Sonar Footprint

Sonar footprint is a function of water depth (20 metres) and beam angle (0.5° X 0.5°). Computed footprint at nadir:

Footprint @ Nadir = $2 \times ((\text{Depth}) \times (\tan \frac{\theta}{2}))$, where θ = Beam Width Footprint = $2 \times ((20 \text{ m}) \times (\tan .25)) = \underline{0.17 \text{ metres}}$

Since this is a 0.5° X 0.5° system, the total footprint at Nadir is: 0.17m X 0.17m

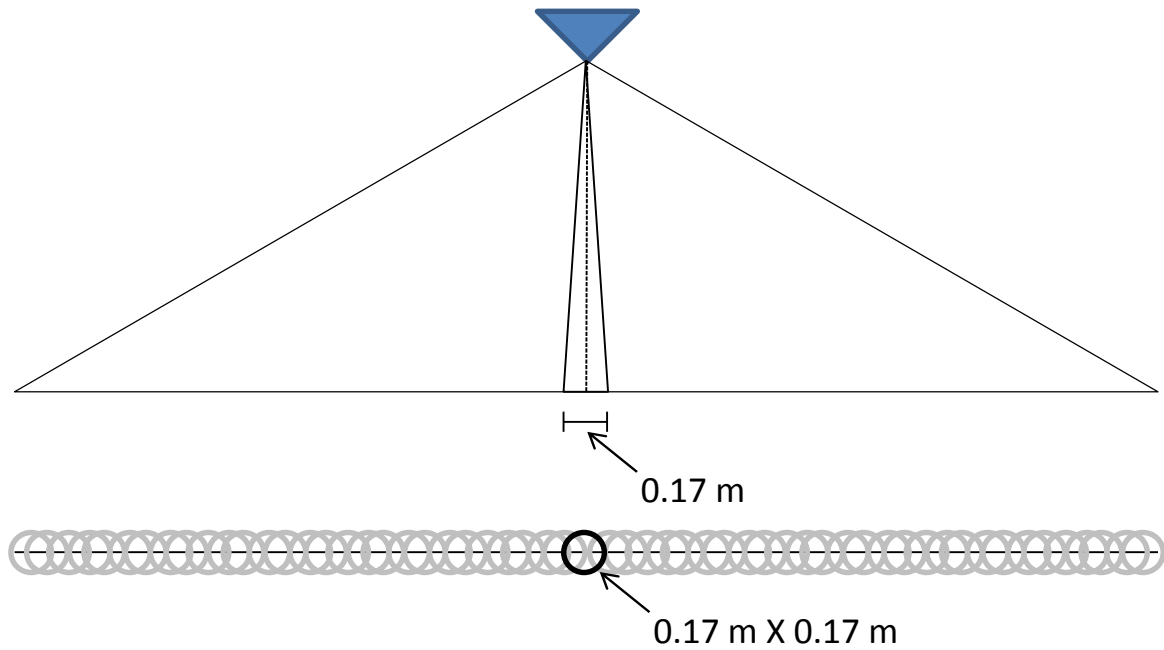

Figure I.1 - Sonar Footprint at Nadir

I-2.3 Sonar Coverage

A benefit of multibeam sonars is the ability to collect a swath of depth estimates with each ping. The example sonar lists swath coverage as 5 times water depth. In 20 metres of water this system will ensonify 100 metres of seafloor every ping. This results in a 100 metre swath (50 metres to port and starboard) along the entire length of the survey line. See Figure I.2.

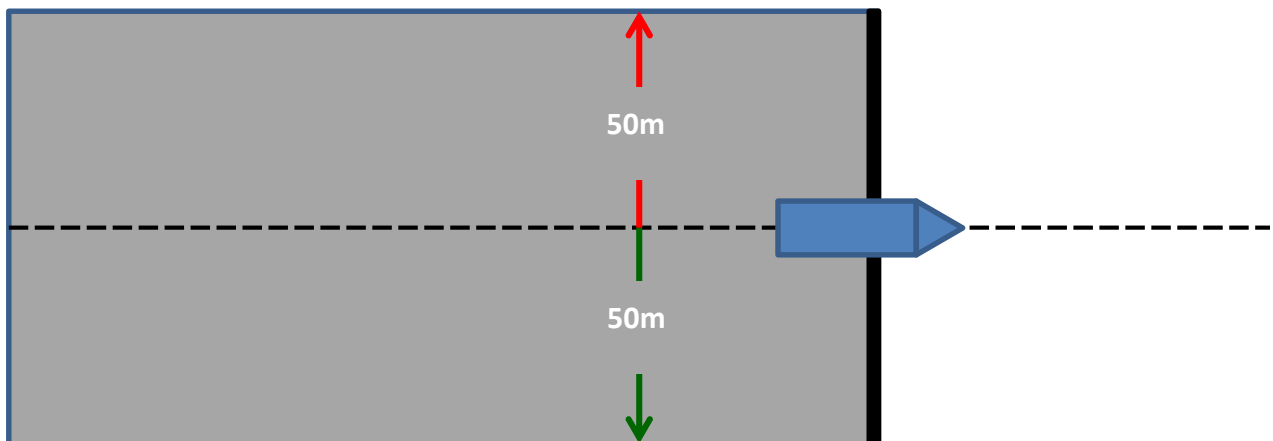

Figure I.2 – Swath Coverage of survey vessel

Total coverage:

17.8 km² of coverage each day.

533.4 km² of total coverage after 30 days.

I-3 Post Survey Process

I-3.1 High-Density Processing Grid

Throughout the survey or at its completion hydrographers will process collected bathymetry, removing gross outliers and erroneous depth estimates. The current trend for processing large quantities of multibeam bathymetry is to generate grids to aid in this process. Generation of a grid improves visualization of the survey and allows for the use of statistics to clean collected data. For the purpose of this example, the described process will produce a high-density seafloor model, selecting a grid resolution representative of twice the sonar footprint at nadir. Since twice the footprint is ~0.3 metres the processing resolution has been increased to 0.5 metres.

Note: The reason for gridding at such a high resolution is to eliminate the need to revisit the full source data point cloud (10.4 Billion Depth Estimates) every time a production effort is initiated. Production and archival of a high-density grid allows the HO to defocus the high-density surface to a coarser resolution more applicable to the intended charting product.

Results: A 0.5 metre grid for the example survey area: 2.1 Billion depth nodes, or < 20% of the total collected depth estimates. See Figure I.3 for a graphic representation of the survey area at 0.5 metre resolution.

I-3.2 Generation of a Production Grid

Referencing the beginning of this Annex, the intended product is a 1:22,000 ENC. Reduction of the “high-density” grid to a 6 metre grid reduces the number of grid nodes from 2.1 Billion to 14.6 million. The resulting 6 metre grid serves as an example of soundings extracted to support chart production. **In total, less than 1% of collected depth estimates make it on a charting product.**

Note: If the 6-metre surface serves as the source for a complimentary S-102 dataset there will be ~169 nodal depths underneath a single charted sounding. See Figure I.3.

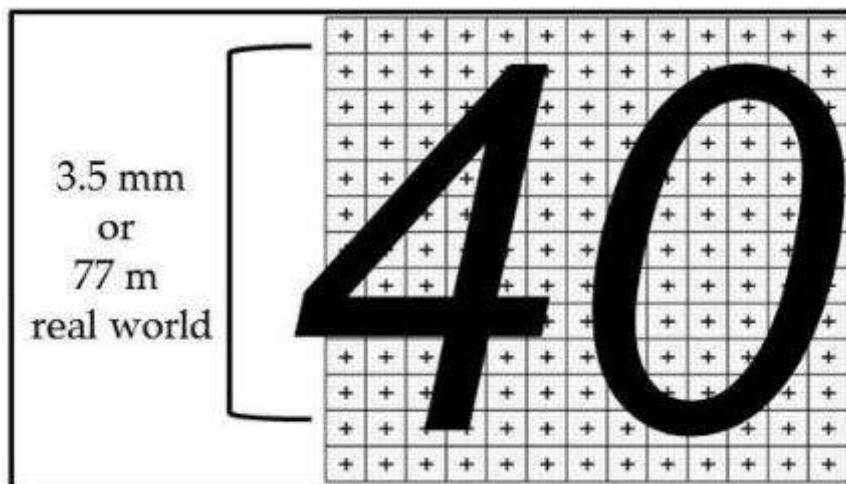

Figure I.3 - Charted Sounding vs 6-metre S-102 Grid

Page intentionally left blank