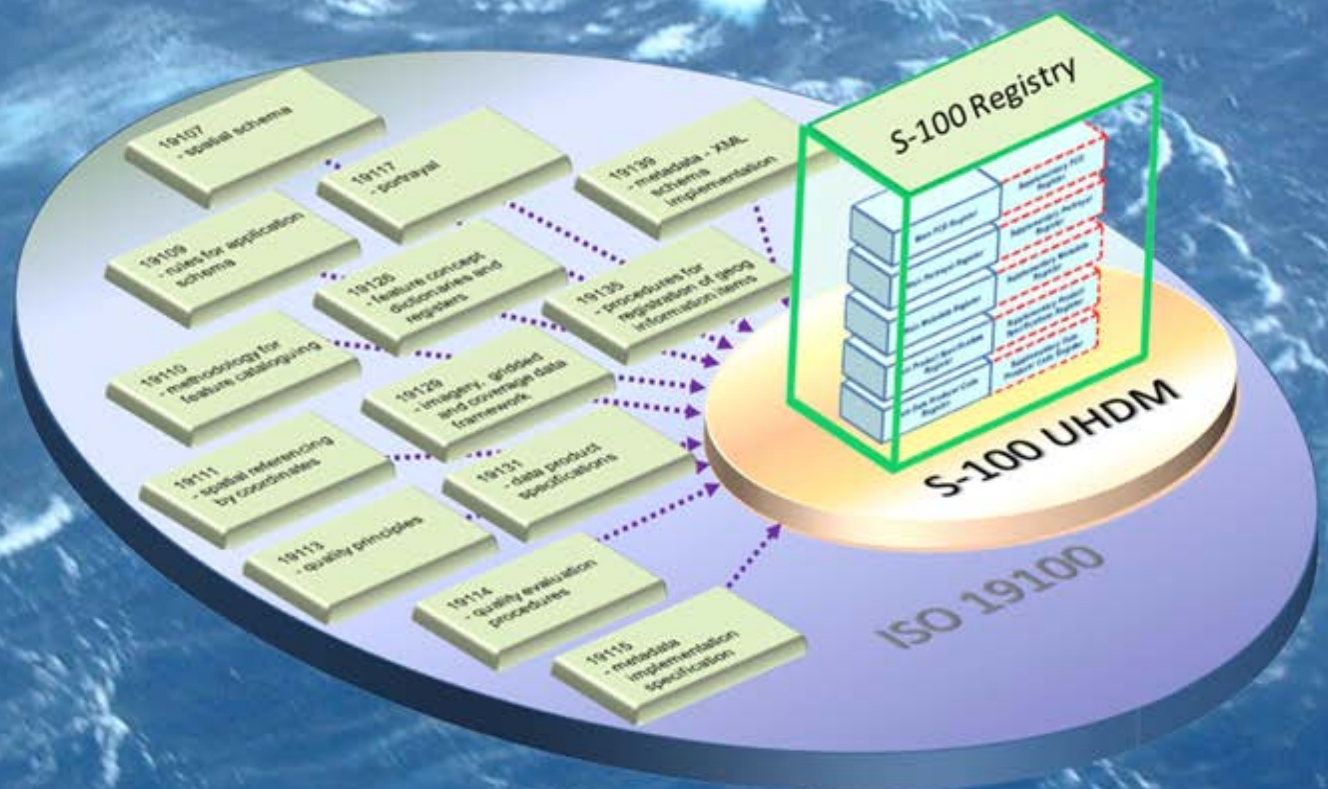




# S-100 - UNIVERSAL HYDROGRAPHIC DATA MODEL

Edition 2.0.0 – January 2015



Published by the  
International Hydrographic Bureau  
MONACO

**©2015 by the International Hydrographic Organization**

Certain parts of the text of this document refer to or are based on the standards of the International Organization for Standardization (ISO). The ISO standards can be obtained from any ISO member and from the Web site of the ISO Central Secretariat at: [www.iso.org](http://www.iso.org)

Certain parts of the text of this document are also based on other material subject to specific copyright notice and licence terms which are inserted in the relevant parts.

Permission to copy and distribute this document is hereby granted provided that this notice and any specific notice, when applicable, are retained on all copies, and that the IHO, the ISO and any other copyright holder are credited when the material is used to form other copyright policies.

# **S-100 – Part 0**

## **Overview**

## Contents

Foreword .....	i
Document Control.....	ii
Introduction.....	iii
0-1 Scope .....	1
0-2 Abbreviations used in this publication .....	1
0-3 Objectives of S-100 .....	2
0-4 S-100 Parts.....	3
0-4.1 Profiles.....	5
0-4.2 Part 1 – Conceptual Schema Language .....	5
0-4.3 Part 2 – Management of IHO Geospatial Information Registers.....	5
0-4.4 Part 2a – Feature Concept Dictionary Registers.....	5
0-4.5 Part 2b – Portrayal Registers .....	5
0-4.6 Part 3 – General Feature Model.....	5
0-4.7 Part 4 – Metadata.....	5
0-4.8 Part 5 – Feature Catalogue .....	6
0-4.9 Part 6 – Coordinate Reference Systems.....	6
0-4.10 Part 7 – Spatial Schema.....	7
0-4.11 Part 8 – Imagery and Gridded Data .....	7
0-4.12 Part 9 – Portrayal .....	7
0-4.13 Part 10 – Encoding Formats.....	7
0-4.14 Part 10a – ISO/IEC 8211 Encoding Schema .....	7
0-4.15 Part 10b – GML Encoding .....	8
0-4.16 Part 11 – Product Specifications .....	8
0-4.17 Part 12 – Maintenance .....	8



## Foreword

Development of S-100 – the *IHO Universal Hydrographic Data Model* was included in the IHO Work Programme in 2001. S-100 has been developed by the IHO Transfer Standards Maintenance and Applications Development (TSMAD) Working Group with active participation from hydrographic offices, industry and academia.

S-100 provides a contemporary hydrographic geospatial data standard that can support a wide variety of hydrographic-related digital data sources, and is fully aligned with mainstream international geospatial standards, in particular the ISO 19100 series of geographic standards, thereby enabling the easier integration of hydrographic data and applications into geospatial solutions.

The primary goal for S-100 is to support a greater variety of hydrographic-related digital data sources, products, and customers. This includes the use of imagery and gridded data, enhanced metadata specifications, unlimited encoding formats and a more flexible maintenance regime. This enables the development of new applications that go beyond the scope of traditional hydrography - for example, high-density bathymetry, seafloor classification, marine GIS, et cetera. S-100 is designed to be extensible and future requirements such as 3-D, time-varying data (x, y, z, and time) and Web-based services for acquiring, processing, analysing, accessing, and presenting hydrographic data can be easily added when required.

The S-100 development and maintenance process is specifically aimed at allowing direct input from non-IHO stakeholders, thereby increasing the likelihood that these potential users will maximise their use of hydrographic data for their particular purposes.

S-100 will eventually replace S-57 – the established *IHO Transfer Standard for Digital Hydrographic Data*. Although S-57 has many good aspects, it has some limitations:

- S-57 has been used almost exclusively for encoding Electronic Navigational Charts (ENCs) for use in Electronic Chart Display and Information Systems (ECDIS).
- S-57 is not a contemporary standard that is widely accepted in the GIS domain.
- It has an inflexible maintenance regime. Freezing standards for lengthy periods is counter-productive.
- As presently structured, it cannot support future requirements (e.g., gridded bathymetry, or time-varying information).
- Embedding the data model within the encapsulation (i.e., file format) restricts the flexibility and capability of using a wider range of transfer mechanisms.
- It is regarded by some as a limited standard focused exclusively for the production and exchange of ENC data.

The transition from S-57 to S-100 will be carefully monitored by the IHO to ensure that existing S-57 users, particularly ENC stakeholders are not adversely affected. S-57 will continue to exist as the designated format for ENC data for the foreseeable future.

In the meantime, all existing and potential users of hydrographic information and data are encouraged to use S-100 as the basis for new applications, seeking input to the further development of the standard if their particular requirements are not yet catered for.

## Document Control

Edition Number	Date	Reference
1.0.0	January 2010	IHO Circular Letter No 83/2009 4 December 2009
2.0.0	June 2015	IHO Circular Letter No 39/2015 05 June 2015
3.0.0	June 2017	

## Introduction

Standards should encapsulate the use of best practice methods and procedures. They should include guidance on how to implement efficient production methods and optimize the quality of an organizations products and services, and should also enable interoperability between disparate technologies through the use of common interfaces. The S-100 standard attempts to achieve all of these objectives. Furthermore it provides a framework of components that can be used by interested communities to develop their own maritime geospatial products and services.

The S-100 standard has been developed with the advantage of hindsight based on experience gained through the development and use of the existing IHO Transfer Standard for Digital Hydrographic Data (known as S-57). S-100 has been documented using an object-oriented notation known as the Unified Modelling Language (UML). (Although UML defines nine types of diagrams, only class, object and package diagrams have been used in S-100).

The S-100 standard provides a theoretical framework of components that are based on the ISO 19100 series of standards and specifications. These standards and specifications are also used as the basis for most contemporary geospatial standards development activities and are closely aligned with other standards development initiatives such as the Open Geospatial Consortium (OGC).

The IHO has also developed an associated Registry which can be used in conjunction with the S-100 standard. The IHO Registry contains the following additional components;

- Feature Concept Dictionary (FCD) Registers.
- Portrayal Registers.
- Registers of IHO producer codes.

The IHO Registry provides the infrastructure and mechanisms required to manage and maintain the resources listed above, and to extend them as required.

### Note

S-100 provides a schema and overarching management procedures for a registry and registers and the IHO Registry is implemented using these concepts.

## 0-1 Scope

S-100 – IHO *Universal Hydrographic Data Model* comprises twelve related parts that give the user the appropriate tools and framework to develop and maintain hydrographic related data, products and registers. These standards specify, for hydrographic and related information, methods and tools for data management, processing, analysing, accessing, presenting and transferring such data in digital/electronic form between different users, systems and locations. By following this set of geospatial hydrographic standards users will be able to build constituent parts of an S-100 compliant product specification.

S-100 conforms as far as is reasonably possible to the ISO TC 211 series of geographical information standards, and where necessary has been tailored to suit hydrographic requirements.

S-100 details the standard to be used for the exchange of hydrographic and related geospatial data between national hydrographic offices as well as between other organizations and for its distribution to manufactures, mariners and other data users.

S-100 comprises multiple parts that profile standards developed by the ISO Technical Committee 211. ISO TC 211 is responsible for the ISO series of standards for geographic information. The objective is that, together, the standards will form a framework for the development of sector specific applications that use geographic information. S-100 is an example of such an application.

This standard specifies the procedures to be followed for:

- 1) establishing and maintaining registers of hydrographic and related information;
- 2) creating product specifications, feature catalogues and a definition of the general feature model;
- 3) using spatial, imagery and gridded data, and metadata specifically aimed at fulfilling hydrographic requirements.

## 0-2 Abbreviations used in this publication

2-D	Two-dimensional
2.5D	Two and a half dimensional
CRS	Coordinate Reference System
CSL	Conceptual schema language
DIS	Draft International Standard
ECDIS	Electronic Chart Display and Information System
ENC	Electronic Navigational Chart
EPSG	European Petroleum Survey Group (Since 2005 OGP Surveying and Positioning Committee)
FCD	Feature Concept Dictionary
FDIS	Final Draft International Standard
GFM	General Feature Model
GML	Geography Markup Language
HSSC	IHO Hydrographic Services and Standards Committee (formerly CHRIS)
ICC	International Color Consortium
IEC	International Electrotechnical Commission
IHB	International Hydrographic Bureau
IHO	International Hydrographic Organization
ISO	International Organization for Standardization
ISO/TC211	ISO Technical Committee for Geographic information/Geomatics

OCL	Object Constraint Language
ODP	Open Distributed Processing
OGC	Open Geospatial Consortium
OGP	International Association of Oil and Gas Producers
OMG	Object Management Group
RNC	Raster Navigational Chart
TC	Technical Committee
TS	Technical Specification
TSMAD	Transfer Standard Maintenance and Application Development Working Group
S-100WG	S-100 Working Group
SVG	Scalable Vector Graphics
UML	Unified Modelling Language
URI	Uniform Resource Identifier
URL	Universal Resource Locator
XLink	XML Linking Language
XMI	XML Metamodel Interchange
XML	Extensible Markup Language
XSD	World Wide Web Consortium XML Schema Definition
XSL	eXtensible Stylesheet Language

### **0-3 Objectives of S-100**

The objectives of S-100 are:

- 1) To comply with the emerging ISO standards for geographic information being produced by ISO TC 211;
- 2) To provide support for a greater variety of marine or hydrographic-related digital data, products and customers;
- 3) To separate the data content from the encoding format, enabling format neutral product specifications;
- 4) To enable manageable flexibility that can accommodate change. The intention is that product specifications will be allowed to evolve through extension without the need to publish new versions of existing product specifications;
- 5) To provide an ISO-conformant registry managed by the IHO containing registers such as feature concept dictionaries and product feature catalogues that are flexible and capable of managed expansion;
- 6) To provide separate registers for different user communities.



## 0-4 S-100 Parts

S-100 comprises multiple parts that are derived from various ISO 19100 series of standards. Table 0-1 lists the individual parts, their associated part numbers and ISO 19100 conformance.

**Table 0-1 — S-100 Parts**

Part Title	Part Number	ISO19100 Standard
Conceptual Schema Language	S-100 Part 1	ISO 19103:2005, Geographic information - Conceptual schema language ISO
Management of IHO Geospatial Information Registers	S-100 Part 2	ISO 19135:2005, Geographic Information - Procedures for registration of items of geographic information
Feature Concept Dictionary Registers	S-100 Part 2a	ISO 19135:2005, Geographic Information - Procedures for registration of items of geographic information  ISO/DIS 19126:2008, Geographic Information – Feature concept dictionaries and registers
Portrayal Registers	S-100 Part 2b	ISO 19135:2005, Geographic Information - Procedures for registration of items of geographic information ISO/DIS 19126:2008, Geographic Information – Feature concept dictionaries and registers ISO 19117:2012, Geographic Information - Portrayal
General Feature Model and Rules for Application Schema	S-100 Part 3	ISO 19109:2005, Geographic information - Rules for application schema
Metadata	S-100 Part 4a	ISO 19115:2005, Geographic information - Metadata.
Metadata for Imagery and Gridded Data	S-100 Part 4b	ISO 19115:2005, Geographic information - Metadata.
Metadata – Data Quality	S-100 Part 4c	ISO 19113, Geographic information - Quality principles ISO 19114, Geographic information - Quality evaluation procedures ISO 19138, Geographic information - Quality measures
Feature Catalogue	S-100 Part 5	ISO 19110:2005, Geographic Information - Methodology for feature cataloguing
Coordinate Reference Systems	S-100 Part 6	ISO 19111:2007, Geographic information - Spatial referencing by coordinates
Spatial Schema	S-100 Part 7	ISO 19107:2003, Geographic information - Spatial schema
Imagery and Gridded Data	S-100 Part 8	ISO 19123:2007, Geographic information - Schema for coverage geometry and functions ISO 19129, Geographic information - Imagery, Gridded and Coverage Data Framework
Portrayal	S-100 Part 9	
Encoding Formats	S-100 Part 10	
ISO/IEC 8211 Encoding	S-100 Part 10a	ISO/IEC 8211:1994, Specification for a data descriptive file for information interchange

		structure implementations
GML Encoding	S-100 Part 10b	ISO 19136:2007 Geographic information - Geography Markup Language
HDF5 Encoding	S-100 Part 10c	HDF5 Data Model and File Format
Product Specifications	S-100 Part 11	ISO 19131:2008 Geographic information – Data product specifications
S-100 Maintenance Procedures	S-100 Part 12	

### **0-4.1. Profiles**

The ISO base standards provide a large number of options to the developer wishing to use them for practical applications. The concept of a profile provides a method of adapting the base standards so that they meet specific implementation requirements.

A profile is a set of one or more base standards and, where applicable, the identification of chosen clauses, classes, subsets, options and parameters of those base standards, that are necessary to accomplish a particular function. ISO 19106 describes two levels of conformance for profiling the ISO 19100 series of standards. Each part of S-100 documents the level used in the conformance statement for that part.

S-100 is a set of profiles of the ISO TC 211 standards for Geographic Information. The relationship between S-100 standard core parts and their ISO base classes is shown in Table 0-1.

### **0-4.2. Part 1 – Conceptual Schema Language**

This Part defines the conceptual schema language and basic data types for use within the IHO community. It identifies the combination of the Unified Modeling Language (UML) static structure diagram, and a set of basic data type definitions as the conceptual schema language for specification of geographic information.

### **0-4.3. Part 2 – Management of IHO Geospatial Information Registers**

The International Hydrographic Organization (IHO) has developed a Registry in conformance with ISO 19135 - *Procedures for registration of items of geographic information*. This registry contains an extensible number of registers, encompassing Feature Concept Dictionaries, Portrayal and Meta Data. This part describes the contents structure and management of these registers.

### **0-4.4. Part 2a – Feature Concept Dictionary Registers**

A feature concept dictionary specifies definitions that may be used to describe geographic information. The use of registers to store definitions will significantly improve the IHO's ability to manage and extend multiple products based on S-100 which can then be made available for use in a relatively short timescale. These registers will support wider use of registered items by making them publicly available and increase their visibility to potential users.

### **0-4.5. Part 2b – Portrayal Registers**

This section is reserved for portrayal schema which are under development.

### **0-4.6. Part 3 – General Feature Model**

This part introduces the rules for developing an application schema which is a fundamental element of any S-100 based product specification. Equally fundamental to the creation of the application schema is a General Feature Model (GFM) which is a conceptual model for features, their characteristics and associations. It also introduces the concept of the information type. The GFM is a profile of the GFM presented in ISO 19109 Rules for Application Schemas.

### **0-4.7. Part 4 – Metadata**

Increasingly, hydrographic organizations are collecting, storing and archiving large quantities of digital data which are becoming an important national asset. Knowledge of the quality of hydrographic data is crucial for the application for the data, as different users and different applications often have different data quality requirements. In order to achieve this, data custodians will need to record quality information about their data (i.e. metadata) in order to assure reliability.

ISO 19115 provides an abstract structure for describing digital geographic information by defining the quality metadata elements and establishing a common set of metadata terminology, definitions, and extension procedures.

This part also describes how to use ISO 19115 metadata classes, elements and conditions, and incorporates rules for populating quality metadata. It also incorporates quality measures as described in ISO 19113, 19114 and 19138.

#### **0-4.8. Part 5 – Feature Catalogue**

A feature catalogue is a document that describes the content of a data product. It uses item types, for example, features and attributes, from one or more feature data dictionaries. The basic level of classification in a feature catalogue is by feature type and information type. A feature catalogue should be available in electronic form for any set of geographic data that contains features. A feature catalogue may also comply with the specifications of this part of S-100 independently of any existing set of geographic data.

A feature catalogue is defined for each product specification. Features and attributes are bound in a feature catalogue. The definitions of features and attributes are drawn from a Feature Concept Dictionary.

This part defines the methodology for cataloguing feature types. It also specifies how the classification of feature types is organized into a feature catalogue and presented to the users of a set of geographic data. This part is applicable to creating catalogues of feature types in previously un-catalogued domains and to revising existing feature catalogues to comply with standard practice. This part applies to the cataloguing of feature types that are represented in digital form. Its principles can be extended to the cataloguing of other forms of geographic data.

Part 5 is applicable to the definition of geographic features at the type level. This international standard is not applicable to the representation of individual instances of each type.

#### **0-4.9. Part 6 – Coordinate Reference Systems**

This part is applicable to producers and users of hydrographic information. Its principles can be extended to many other forms of geographic information such as maps, charts, and text documents.

This part defines the conceptual schema for the description of spatial referencing by coordinates. It describes the minimum data required to define a one, two and three dimensional spatial coordinate reference. All the elements necessary to fully define spatial referencing by means of coordinate systems and datums are contained in this section. It also describes the information required to change coordinates from one coordinate reference system to another and all the elements necessary to describe the parameters and methods of coordinate operations. Coordinate operations include projections and datum transformations.

Coordinate reference system information can be presented in full using the elements defined in this part or by reference to a register of coordinate reference system information. A register of coordinate reference system information may be managed in accordance with ISO 19135 (see Part 2).

There are no plans for the IHO to implement a register of coordinate reference systems. An example of an existing register of coordinate reference system information which may be used is the EPSG geodetic parameter dataset which is managed by the Surveying and Positioning Committee of the OGP. Complete CRS definitions may be communicated by means of the namespace EPSG and a code, such as 4326 (i.e. EPSG:4326). This code within the EPSG namespace identifies the ellipsoidal coordinate system based on WGS84 datum. The EPSG database is not managed in accordance with ISO 19135.

#### **0-4.10. Part 7 – Spatial Schema**

This part defines the information necessary for describing and manipulating the spatial characteristics of features. It is based on ISO 19107 - *Geographical Information - Spatial schema*, however the spatial requirements of S-100 are less comprehensive than the requirements of ISO 19107. This profile contains the subset of ISO 19107 classes which are included in S-100.

#### **0-4.11. Part 8 – Imagery and Gridded Data**

This part identifies the content model for gridded data for use in Hydrographic and related applications, including imagery and gridded data. It describes the organization, type of grid and associated metadata and spatial referencing. The encoding and portrayal of imagery and gridded data is external to this part of S-100, although the manner by which encoding and portrayal makes use of the identified content models are identified. This part is based on the ISO 19129 Imagery, gridded and coverage data framework.

#### **0-4.12. Part 9 – Portrayal**

This part specifies the portrayal model for defining and organizing symbols and portrayal rules necessary to portray S-100 product Features.

#### **0-4.13. Part 10 – Encoding Formats**

This part covers encoding formats. S-100 does not mandate particular encoding formats so it is left to developers of product specifications to decide on suitable encoding standards and to document their chosen format. The issue of encoding information is complicated by the range of encoding standards that are available. Table 0-2 provides an incomplete list of available encoding standards from which schemas can be developed as extensions to S-100 as required.

**Table 0-2 – Example Encoding Standards**

<b>Encoding Name</b>	<b>Description</b>
ISO/IEC 8211	The encoding standard currently used to encode S-57 ENC data.
GML	Geography Markup Language
XML	Extensible Markup Language
GeoTIFF	Extension of the TIFF specification to allow the storage of geo-referencing information.
HDF-5	Hierarchical Data Format version 5
JPEG2000	Joint Photographic Experts Group - Commonly used method for the compression of photographic images.

Successful data interchange depends on knowledge of the content, defined in the feature catalogue, and the structure, defined in the application schema, of a dataset, and the encoding rules that are applied.

#### **0-4.14. Part 10a – ISO/IEC 8211 Encoding Schema**

This part specifies the structure and physical constructs required for the implementation of exchange data sets encoded in the ISO 8211 format.



#### **0-4.15. Part 10b – GML Encoding**

This part specifies the structure and physical constructs required for the implementation of the Geographic Markup Language data format.

#### **0-4.16. Part 10c – HDF5 Data Model and File Format**

This part specifies the structure and constructs required for the implementation of exchange datasets encoded in the Hierarchical Data Format version 5 (HDF5).

#### **0-4.17. Part 11 – Product Specifications**

This part explains Product specifications. It is a descriptive IHO profile of ISO 19131 for data product specifications and describes data product specifications for hydrographic and hydrographically-related requirements for geographic data products.

The aim of this profile is to ensure a clear and consistent structure for any data product specification. This profile will conform with all the other standards that have been developed under the IHO S-100 framework.

A product specification is a description of all the features, attributes and relationships of a given application and their mapping to a dataset. It is a complete description of all the elements required to define a particular geographic data product.

#### **0-4.18. Part 12 – Maintenance**

This part specifies procedures to be followed in maintaining and publishing the various parts of S-100. It does not cover the maintenance of the S-100 registry, as register owners specify the procedures for updating their registers. Additionally, it does not cover the maintenance regime of product specifications that are written against S-100.

NOTE All S-100 based product specifications will include a maintenance section.

# **S-100 – Part 1**

## **Conceptual Schema Language**

## Contents

1-1	Scope .....	1
1-2	Conformance .....	1
1-3	Normative references .....	1
1-4	The S-100 UML Profile .....	2
1-4.1	Introduction.....	2
1-4.2	General usage of UML .....	2
1-4.3	Classes.....	2
1-4.4	Attributes .....	3
1-4.5	Basic data types .....	3
1-4.5.1	General considerations .....	3
1-4.5.2	Primitive types .....	3
1-4.5.3	Complex types.....	5
1-4.6	Predefined derived types.....	8
1-4.7	Enumerated types .....	8
1-4.8	Codelist types.....	9
1-4.9	Relationships and associations .....	10
1-4.9.1	Relationships .....	10
1-4.9.2	Association, composition and aggregation.....	11
1-4.10	Stereotypes .....	13
1-4.10.1	Use of standard UML stereotypes for class/classifier.....	13
1-4.11	Optional, conditional and mandatory – attributes and associations.....	14
1-4.12	Naming and name spaces.....	14
1-4.13	Notes .....	15
1-4.14	Packages.....	15
1-4.15	Documentation of models in S-100.....	16

## 1-1 Scope

This Part defines the conceptual schema language and basic data types for use within the IHO community. It identifies the combination of the Unified Modeling Language (UML) static structure diagram, and a set of basic data type definitions as the conceptual schema language for specification of geographic information. (UML is a standardized general-purpose modelling language in the field of software engineering. It includes a set of graphical notation techniques to create abstract models of specific systems. UML combines the best practice from data modelling concepts such as entity relationship diagrams, work flow, object modelling and component modelling).

Secondly, this Part provides guidelines on how UML should be used to create standardized geographic information and service models that are a basis for achieving the goal of interoperability. Since it deals with the UML, a section with specific UML terms and definitions is provided, in addition to these terms being included in Annex 1 (Terms and Definitions).

## 1-2 Conformance

Any conceptual schema written for a specification that claims conformance to this part of S-100 shall conform to the rules set out in clause 5. This profile conforms to conformance class 2 of ISO 19106:2004.

## 1-3 Normative references

The following referenced documents are required for the application of this document. For dated references, only the edition cited applies. For undated references, the latest edition of the referenced document (including amendments) applies.

ISO 19103:2005(E), *Geographic information — Conceptual schema language*

ISO 8601:2004(E), *Data elements and interchange formats — Information interchange — Representation of dates and times*

ISO 19136: *Geographic Information – Geography Markup Language*

ISO 25964-1: *Information and documentation — Thesauri and interoperability with other vocabularies — Part 1: Thesauri for information retrieval.*

ISO 25964-2: *Information and documentation — Thesauri and interoperability with other vocabularies — Part 2: Interoperability with other vocabularies*

OGC 10-129r1: *Geographic Information – Geography Markup Language (GML) – Extended schemas and encoding rules*

OMG Unified Modeling Language (OMG UML), Superstructure, V2.1.2

RFC 3986, *Uniform Resource Identifier (URI): Generic Syntax*. T. Berners-Lee, R. Fielding, L. Masinter. Internet Standard 66, IETF. URL: <http://www.ietf.org/rfc/rfc3986.txt> or <http://www.rfc-editor.org/info/std66>

RFC 2141, *URN Syntax*. R. Moats. IETF RFC 2141, May 1997. URL: <http://www.rfc-editor.org/info/rfc2141>

SKOS: *SKOS – Simple Knowledge Organization System – Reference*. W3C

Recommendation, 2009. <http://www.w3.org/TR/2009/REC-skos-reference-20090818/>.

## **1-4 The S-100 UML Profile**

### **1-4.1 Introduction**

This clause provides rules and guidelines on the use of UML within the field of geographic information.

The subclauses are structured as follows:

- 1) General usage of UML
- 2) Classes
- 3) Attributes
- 4) Basic data types
- 5) Predefined derived types
- 6) Enumerated types
- 7) Codelist types
- 8) Relationships and associations
- 9) Stereotypes
- 10) Optional, conditional and mandatory – attributes and associations
- 11) Naming and name spaces
- 12) Notes
- 13) Packages
- 14) Documentation of models in S-100

### **1-4.2 General usage of UML**

UML (The Unified Modeling Language) shall be used in a manner that is consistent with UML 2. Normative models shall use class diagrams and package diagrams. Other UML diagram-types may be used informatively. All normative models shall contain complete definitions of attributes, associations, and appropriate data type definitions.

### **1-4.3 Classes**

A class is a description of a set of objects that share the same attributes, operations, methods, relationships, behaviour and constraints. A class represents a concept being modelled. Depending on the kind of model, the concept may be based on the real world (for a conceptual model), or it may be based on implementation between platform independent system concepts (for specification models) or platform specific system concepts (for implementation models).

A classifier is a generalization of a class that includes other class-like elements, such as data types, actors and components. A UML class has a name, a set of attributes, a set of operations and constraints. In S-100 operations are not used. A class may participate in associations.

A class according to the S-100 parts is viewed as a specification and not as an implementation.

The use of multiple inheritance shall be minimized, because it tends to increase model complexity.

An Abstract class is specified by having the class name in italics.



## 1-4.4 Attributes

UML notation for an attribute has the form:

```
opt visibility_opt name : opt package :: opt type_opt opt [multiplicity] opt opt = initial value_opt opt {property-string}_opt
```

An attribute must be unique within the context of a class and its supertypes, or else be a derived attribute, i.e. an attribute redefined from a supertype.

The visibility of attributes is shown by the symbols in Table 1-1. Protected and private visibility is normally not used in the standard specifications. The appropriate visibility symbols shall be used. The same visibility symbols are used for associations.

**Table 1-1 — Visibility of Attributes**

Symbol	Description
+	Public visibility
#	Protected visibility
-	Private visibility
/	Derived Attribute

All attributes must be typed and the type must exist, the constructed/defined types. A type must always be specified, there is no default type.

If no explicit multiplicity is given, it is assumed to be 1.

An attribute may define a default value, which is used when an object of that type is created.

Default values are defined by explicit default values in the UML definition of the attribute.

The following properties can be used:

- `readOnly` – the value of the attribute cannot be changed and must be initialised.
- `ordered` – applies to attributes of a multiplicity of more than one in which the order of the elements is meaningful and must be maintained.

EXAMPLES    `+ center: Point = (0,0) {readOnly}`  
                   `+ origin: Point [0..1]    // multiplicity 0..1 means that this is optional`  
                   `+ controlPoints : Point [2..*] {ordered}`

## 1-4.5 Basic data types

### 1-4.5.1 General considerations

The basic data types are grouped into two categories:

- 1) Primitive types: Fundamental types for representing values, e.g. `CharacterString`, `Integer`, `Boolean`, `Date`, `Time`, etc.
- 2) Complex types: A combination of types, e.g. a combination of measure types and units of measurement.

The repertoire of basic data types is described in the following subclauses.

### 1-4.5.2 Primitive types

The following primitive types are supported in the S-100 UML Diagrams.

**Table 1-2 — Data Types**

Name	Description
Integer	A signed integer number, the representation of an integer is encapsulation and usage dependent. EXAMPLE            29, -65547
PositiveInteger	An unsigned integer number greater than 0.
NonNegativeInteger	An unsigned integer number greater than or equal to 0
Real	A signed real (floating point) number consisting of a mantissa and an exponent, the representation of a real is encapsulation and usage dependent. EXAMPLE            23.501, -1.234E-4, -23.0
Boolean	A value representing binary logic. The value can be either true or false.
CharacterString	A CharacterString is an arbitrary-length sequence of characters including accents and special characters from repertoire of one of the adopted character sets
Date	A date gives values for year, month and day according to the Gregorian Calendar. Character encoding of a date is a string which shall follow the calendar date format (complete representation, basic format) for date specified by ISO 8601. EXAMPLE            19980918 (YYYYMMDD)
Time	A time is given by an hour, minute and second. Character encoding of a time is a string that follows the local time (complete representation, basic format) format defined in ISO 8601. Time zone according to UTC is optional.  EXAMPLE            183059 or 183059+0100 or 183059Z  The complete representation of the time of 27 minutes and 46 seconds past 15 hours locally in Geneva (in winter one hour ahead of UTC), and in New York (in winter five hours behind UTC), together with the indication of the difference between the time scale of local time and UTC, are used as examples. Geneva: 152746+0100 New York: 152746-0500
DateTime	A DateTime is a combination of a date and a time type. Character encoding of a DateTime shall follow ISO 8601 (see above). EXAMPLE: 19850412T101530
TruncatedDate	A TruncatedDate allows a partial date to be given. At least one of the following components must be present with omitted elements replaced by the appropriate number of hyphens. The encoding of this type is as follows: YYYYMMDD Components: YYYY    Year    integer between 0000 and 9999 MM      Month    integer between 01 – 12 (inclusive) DD      Day      integer between 01 and 28, 29, 30, or 31 (inclusive), consistent with year and month values if these are specified  At least one component must be specified. Unspecified components must be represented with the appropriate number of hyphens.

### 1-4.5.3 Complex types

#### 1-4.5.3.1 UnlimitedInteger

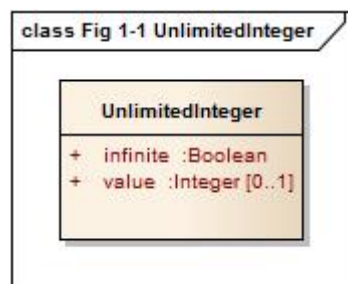


Figure 1-1 - UnlimitedInteger

A signed integer number whose value may be infinite.

#### 1-4.5.3.2 Matrix

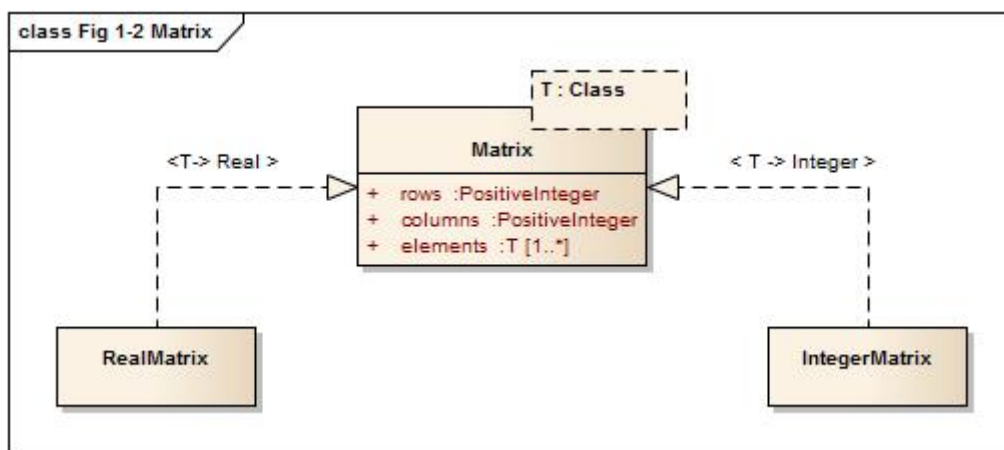


Figure 1-2 – Matrix

A grid of either real or integer elements.

#### 1-4.5.3.3 S100\_Multiplicity

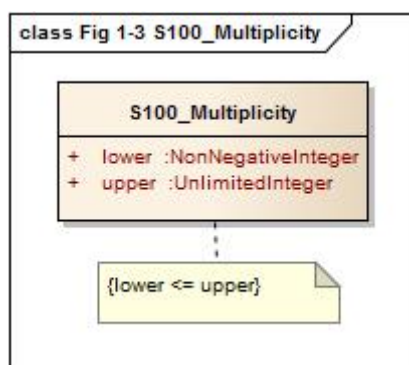


Figure 1-3 – S100\_Multiplicity

Defines a multiplicity range from lower to upper. The upper boundary may be infinite.

1-4.5.3.4 S100\_NumericRange

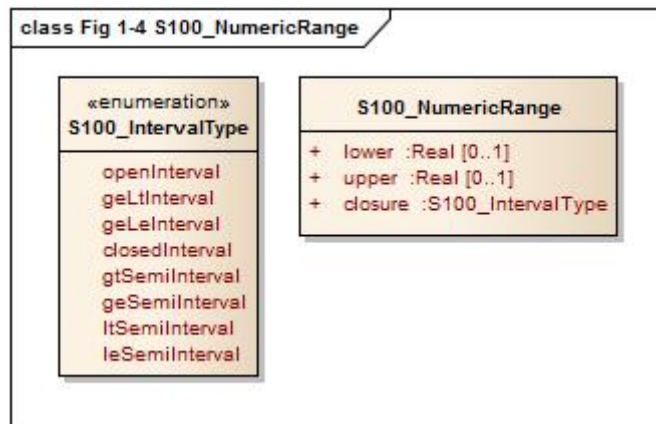


Figure 1-4 – S100\_NumericRange

Specifies a numeric interval by its lower and upper boundary and the closure type of the interval.

NOTE The attribute **lower** must be used for all closures except **ltSemilInterval** or **leSemilInterval**. The attribute **upper** must be used for all closures except **gtSemilInterval** or **geSemilInterval**.

NOTE A single-value interval shall be encoded with **upper** = **lower** and set **closure** to **closedInterval**.

The closure of the interval is defined by the enumeration S100\_IntervalType. The literals have the following meaning:

Table 1-3 — Interval Types

Name	Description	Notation	Definition (where $a \leq b$ )
openInterval	The open interval	$(a,b)$	$a < x < b$
geLtInterval	The right half-open interval	$[a,b)$	$a \leq x < b$
gtLeInterval	The left half-open interval	$(a,b]$	$a < x \leq b$
closedInterval	The closed interval	$[a,b]$	$a \leq x \leq b$
gtSemilInterval	The left half-open ray	$(a, \infty)$	$a < x$
geSemilInterval	The left closed ray	$[a, \infty)$	$a \leq x$
ltSemilInterval	The right half-open ray	$(-\infty, a)$	$x < a$
leSemilInterval	The right closed ray	$(-\infty, a]$	$x \leq a$

NOTE Intervals using the round brackets ( or ) as in the general interval (a,b) or specific examples (-1,3) and (2,4) are called **open intervals** and the endpoints are not included in the set. Intervals using the square brackets [ or ] as in the general interval [a,b] or specific examples [-1,3] and [2,4] are called **closed intervals** and the endpoints are included in the set. Intervals using both square and round brackets [ and ) or ( and ] as in the general intervals (a,b) and [a,b) or specific examples [-1,3) and (2,4] are called **half-closed intervals** or **half-open intervals**.

NOTE Intervals that have one of  $\pm\infty$  as an end point are called rays or half-lines.

EXAMPLE The interval "(10,42)" indicates the set of all real numbers between 10 and 42 but does *not* include 10 or 42, the first and last numbers of the interval, respectively. The interval "[10,42]" includes every number between 10 and 42 *as well as* 10 and 42.

### 1-4.5.3.5 S100\_UnitOfMeasure

A unit of measurement is a well defined comparator for a magnitude.

In S-100 a unit of measurement is comprised of a name and optionally of a definition and a symbol.

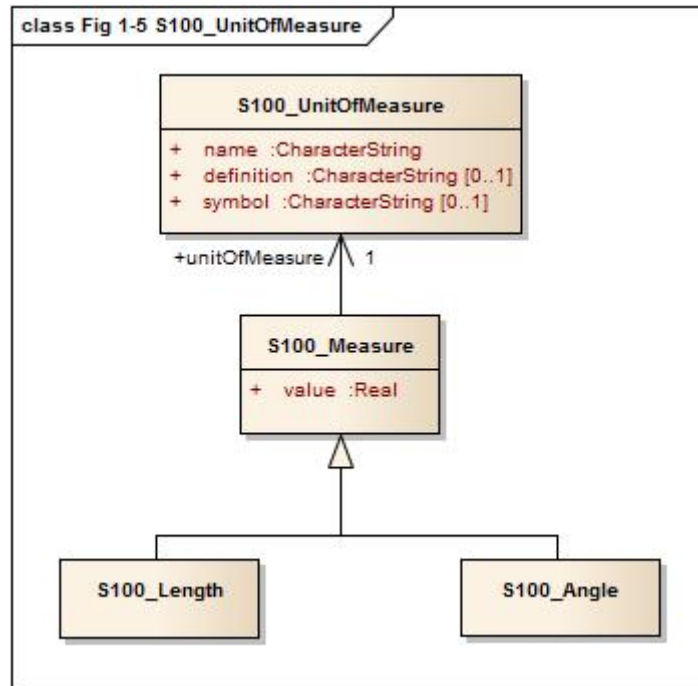


Figure 1-5 – S100\_UnitOfMeasure

### 1-4.5.3.6 S100\_Measure

A measure is the result of a measurement. A measurement is the estimation of the magnitude of some characteristic of an entity, such as its length or weight, relative to a unit of measurement. A measure consists of the actual magnitude (the value) and the unit of measurement.

### 1-4.5.3.7 S100\_Length

The measure of distance as an integral, for example the length of curve, or the perimeter of a polygon as the length of the boundary.

### 1-4.5.3.8 S100\_Angle

The amount of rotation needed to bring one line or plane into coincidence with another, generally measured in radians or degrees.

### 1-4.5.3.9 S100\_IndeterminateDate

An indeterminate instant is an instant related by a specified temporal relation to a date specified in truncated format. The temporal relations allowed are 'before' and 'after' and indicate respectively that the instant is before or after the time instant specified by the date-time component.



Figure 1-6 – S100\_IndeterminateDate

Example (Informative): A mariner report dated at an unknown instant before the year 1950 is dated by an attribute *reportDate* with sub-attributes shown below:

Sub-attribute	Value	Remark
indeterminatePosition	1 (before)	At an indeterminate time before January 1, 1950.
value	1950----	

### 1-4.6 Predefined derived types

Derived types are derived from the basic types or other derived types by restriction of the range of allowed values. The following derived types are defined in S-100. Product specifications may define additional derived types.

Table 1-4 — Predefined Derived Types

Name	Description	Derived From
URI	A uniform resource identifier as defined in RFC 3986. Character encoding of a URI shall follow the syntax rules defined in RFC 3986. EXAMPLE        http://registry.iho.int	CharacterString
URL	A uniform resource locator (URL) is a URI that provides a means of locating the resource by describing its primary access mechanism (RFC 3986). EXAMPLE        http://registry.iho.int	URI
URN	A persistent, location-independent, resource identifier that follows the syntax and semantics for URNs specified in RFC 2141. EXAMPLE        urn:iho:s101:1:0:0:AnchorageArea	URI

### 1-4.7 Enumerated types

An enumerated type declaration defines a list of valid identifiers of mnemonic words. Attributes of an enumerated type can only take values from this list.

EXAMPLE



## Figure 1-7 — Enumeration

Enumerations are modelled as classes that are stereotyped as <<enumeration>>. An enumeration class can only contain simple attributes which represent the enumeration values. Other information within an enumeration class is void. An enumeration is a user-definable data type, whose instances form a list of named literal values. Usually, both the enumeration name and its literal values are declared. The extension of an enumeration type will imply a schema modification.

### 1-4.8 Codelist types

Codelist types may be used for open enumerations whose membership cannot be known at the level of the product specification, for reuse of information model fragments, or for more efficient catalogue management. Specifically, they may be used:

- a) for enumerations whose members are not all knowable at the level of the application schema;
- b) for lists defined or controlled by external authorities;
- c) for lists common to multiple S-100 domains;
- d) if the set of allowed values needs to be extended without a major revision of the data specification;
- e) long lists of potential values which would clutter or bloat feature catalogues.

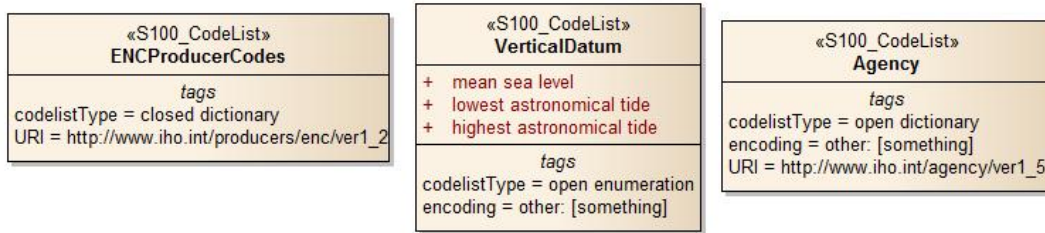
For example, ISO 19115 (Metadata) defines several codelists, because it needs to define enumerated types whose membership is determined by domain and circumstances (e.g., distribution media).

A codelist type declaration must be one of the following 3 types:

- 1) An **open enumeration**, which is a list of valid key-value combinations (i.e., code-value mappings) with a provision for allowing user communities to provide allowed values in a specified format.
- 2) A **closed dictionary**, which is a dictionary (vocabulary) of key-value combinations in a known format, identifiable by a Uniform Resource Identifier and which can be located by the application of standard modern techniques for locating resources. Additional values cannot be provided.
- 3) An **open dictionary**, which is a dictionary (vocabulary) of key-value combinations in a known format, identifiable by a Uniform Resource Identifier, as defined above, with the additional proviso that additional values conforming to a specified format may be provided.

Codelists are modelled as classes that are stereotyped as <<S100\_Codelist>>. Codelists of the first type must list the known literals as attributes. In the second and third types, no attributes are listed but the vocabulary is identified by a URI. A Codelist classifier must have tagged values which define its representation, extensibility, and anticipated encoding. Figure 1-8 shows 3 examples of codelists:

- 1) The **VerticalDatum** codelist is an example of a codelist modelled as an extensible enumeration (indicated by the tagged value *codelistType*="open enumeration") which can be extended by values of the form "other: ...", indicated by the tagged value *encoding*="other: [something]".
- 2) The **ENCProducerCodes** codelist is an example of a codelist modelled by an external dictionary which can take only the values in that dictionary (indicated by tagged value *codelistType*="closed dictionary"). The dictionary is identified by the tagged value *URI*=[http://www.iho.int/producers/enc/ver1\\_5](http://www.iho.int/producers/enc/ver1_5).
- 3) The **Agency** codelist is an example of a codelist modelled by an external dictionary which can take additional values (indicated by the tagged value *codelistType*="open dictionary"). The dictionary is identified by the tagged value *URI*=[http://www.iho.int/agency/ver1\\_5](http://www.iho.int/agency/ver1_5). The list can be extended by values of the form "other: ...", indicated by the tagged value *encoding*="other: [something]".

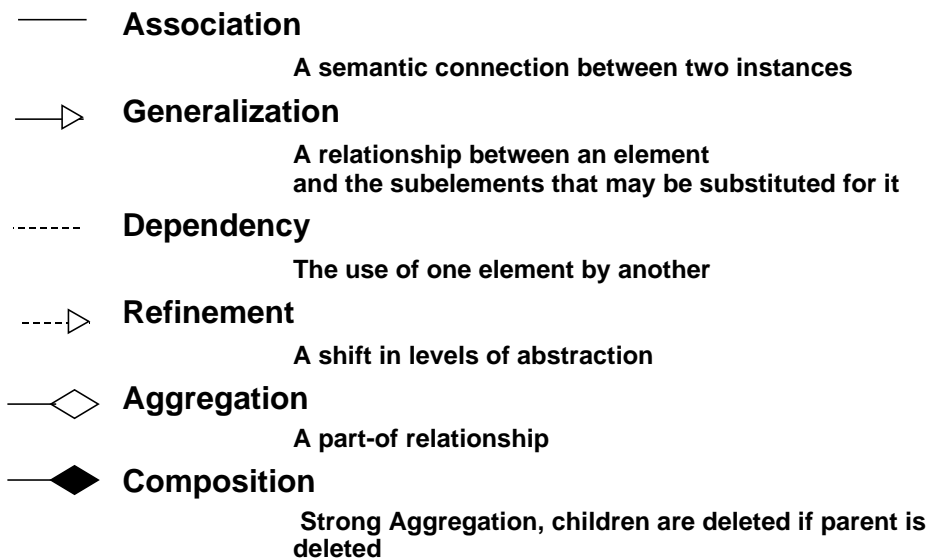


**Figure 1-8 – Codelists**

Implementations (and specific encodings) are allowed to depart from *encoding* hints. Different implementations may use different encoding schemes (and translation tables to other encoding schemes). For example preparation of a feature catalogue for an ISO 8211 encoding may transform a dictionary into an XML fragment which is merged into (or *Xinclude'd* in) the XML feature catalogue (obviously an additional procedure is needed for maintenance). This allows XML/GML encodings to use the dictionary while still allowing other encodings to function within their limitations.

## 1-4.9 Relationships and associations

### 1-4.9.1 Relationships



**Figure 1-9 — Different kinds of relationships**

A relationship in UML is a concrete semantic connection among model elements. Kinds of relationships include association, generalization, aggregation/composition, meta relationship, flow, and several kinds grouped under dependency. In ISO 19103 there is a clear distinction between the general term “relationship,” and the more specific term “association”. Both are defined for class to class linkages, but association is reserved for those relationships that are in reality instance to instance linkages. “Generalization,” “realization” and “dependency” are class to class relationships. “Aggregation,” and other object to object relationships, are more restrictively called “associations.” It is always appropriate to use the most restrictive term in any case, so in speaking of instantiable relationships, use the term “association.”

In S-100, generalization, dependency and refinement are used according to the standard UML notation and usage. In the following the usage of association, aggregation and composition is described further.



### 1-4.9.2 Association, composition and aggregation

An association in UML is the semantic relationship between two or more classifiers (e.g. class, interface, type, ...) that involves connections among their instances.

An association is used to describe a relationship between two or more classes. In addition to an ordinary association, UML defines two special types of associations called aggregation and composition. The three types have different semantics. An ordinary association shall be used to represent a general relationship between two classes. The aggregation and composition associations shall be used to create part-whole relationships between two classes.

A binary association has a name and two association-ends. An association-end has a role name, a multiplicity statement, and an optional aggregation symbol. An association-end shall always be connected to a class.

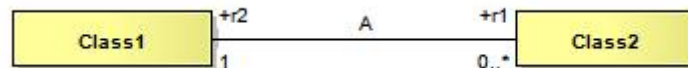


Figure 1-10 — Association

Figure 1-10 shows an association named "A" with its two respective association-ends. The role name is used to identify the end of an association, the role name r1 identifies the association-end which is connected to the class named class2. The multiplicity of an association-end can be one of exactly-one (1), zero-or-one (0..1), one-or-more (1..\*), zero-or-more (0..\*) or an interval (n..m). Viewed from the class, the role name of the opposite association-end identifies the role of the target class. We say that class2 has an association to class1 that is identified by the role r2 and which as a multiplicity of exactly one. The other way around, we can say that class1 has an association to class2 that is identified by the role name r1 with multiplicity of zero-or-more. In the instance model we say that class1 objects have a reference to zero-or-more class2 objects and that class2 objects have a reference to exactly one class1 object.

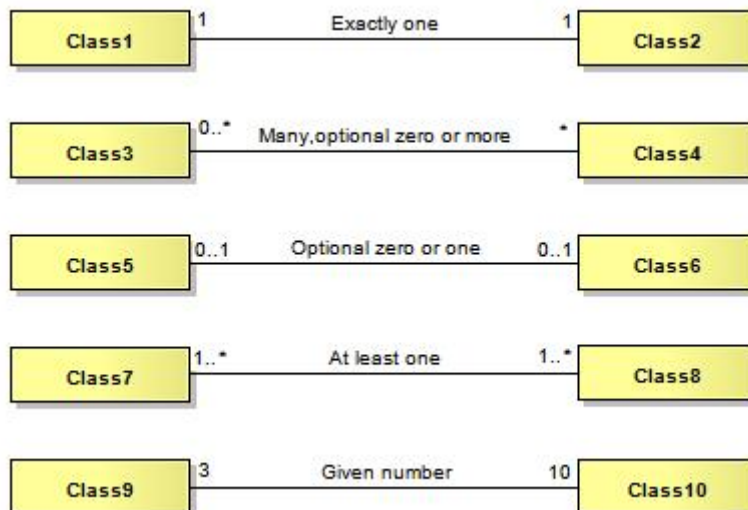
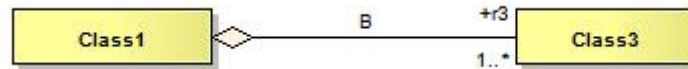


Figure 1-11 — Specification of multiplicity

The number of instances that can participate at one end in an association (or attribute) is specified in Figure 1-11.

An aggregation association is a relationship between two classes, in which one of the classes plays the role of container and the other plays the role of a containee. Figure 1-12 shows an example of an aggregation. The diamond-shaped aggregation symbol at the association-end close to class1 indicates that class1 is an aggregation consisting of class3. The meaning of

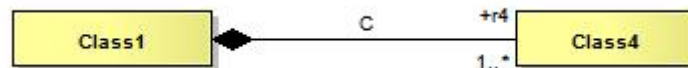
this is that class3 is a part of class1. In the instance model, **class1** objects will contain one-or-more **class3** objects. The aggregation association shall be used when the containee objects (that represent the parts of a container object) can exist without the container object. Aggregation is a symbolic short-form for the part-of association but does not have explicit semantics. It allows for sharing of the same objects in multiple aggregations. If a stronger aggregation semantics is required, composition shall be used as described below. It is possible also to define role name and multiplicity at the diamond shaped end as well.



**Figure 1-12 — Aggregation**

A composition association is a strong aggregation. In a composition association, if a container object is deleted then all of its containee objects are deleted as well. The composition association shall be used when the objects representing the parts of a container object, cannot exist without the container object. Figure 1-13 shows a composition association in which the diamond-shaped composition symbol has a solid fill. Here **class1** objects consist of one-or-more **class4** objects, and the **class4** objects cannot exist unless the **class1** object also exists. The required (implied) multiplicity for the owner class is always one. The containees, or parts, cannot be shared among multiple owners.

It is possible also to define role name at the diamond shaped end as well, but the multiplicity will always be at most one. Composition shall be used to have the semantic effect of containment. Composition should be used with care, in particular one should consider the different requirements from various application perspectives before introducing this constraint. The application of the composition construct should be considered within the context of a model, (rather than the scope), where context means the application domain within which the application must be consistent. This is in order to prevent problems where different applications have different requirements for composition.



**Figure 1-13 — Composition (strong aggregation)**

All associations shall have cardinalities defined for both association ends. At least one role name shall be defined. If only one role name is defined, the other will by default be `inv_rolename`.

All association ends (roles) representing the direction of a relationship must be named or else the association itself must be named. The name of an association end (the rolename) must be unique within the context of a class and its supertypes. The direction of an association must be specified. If the direction is not specified, it is assumed to be a two-way association. If one-way associations are intended, the direction of the association can be marked by an arrow at the end of the line. If only the association is named, the direction of the association shall be specified.

Every UML association has navigability attributes that indicate which player in the association has direct access to the association opposite role. The default logic for an unmarked association is that it is two-way. Associations that do not indicate navigability are two-way in that both participants have equal access to the opposite role. Two-way navigation is not common or necessary in many client-to-server operations. The counterexample to this may be notification services, where the server often instigates communication on a prescribed event. The use of two-way relations that introduce unreasonable package dependencies shall be minimized. One-way relations shall be used when that is all that is needed.

If an association is navigable in a particular direction, the model shall supply a “role name” that is appropriate for the role of the target object in relation to the source object. Thus in a 2-way association, two role names will be supplied. The default role name is “the<target class name>” in which the target class is referenced from the source class (this is the default name

in many UML tools). Association names are of secondary importance and actually are more for documentation purposes. Sometimes they can, however, be used for generating association-manager objects in environments that support associations as a first-class citizen concept.

Multiplicity refers to the number of relationships of a particular kind that an object can be involved in. If an association end were not navigable, putting a multiplicity constraint on it would require an implementation to track the use of association by other objects (or to be able to acquire the multiplicity through query). If this is important to the model, the association shall be two-way navigable to make enforcement of the constraint more tenable. In other words, a one-way relation implies a certain “don’t care” attitude towards the non-navigable end.

N-ary relationships, for  $N > 2$  shall be avoided whenever possible, in order to reduce complexity. Multiplicity for associations are specified as UML multiplicity specifications. An association with role names can be viewed as similar to defining attributes for the two classes involved, with the additional constraint that updates and deletions are consistently handled for both sides. For one-way associations, it thus becomes equivalent to an attribute definition. The recommendation for S-100 is to use the association notation for all cases except for those involving attributes of basic data types.

## 1-4.10 Stereotypes

### 1-4.10.1 Use of standard UML stereotypes for class/classifier

In S-100 the following stereotypes are used:

- a) <<Interface>> a definition of a set of operations that is supported by objects having this interface.
- b) <<Type>> a stereotyped class used for specification of a domain of instances (objects), together with the operations applicable to the objects. A type may have attributes and associations.
- c) <<Enumeration>> A data type whose instances form a list of named literal values. Both the enumeration name and its literal values are declared. Enumeration means a short list of well-understood potential values within a class. Classic examples are Boolean that has only 2 (or 3) potential values TRUE, FALSE (and NULL). Most enumerations will be encoded as a sequential set of Integers, unless specified otherwise. The actual encoding is normally only of use to the programming language compilers. In S-100 Codelists taken from the ISO 19100 standards are classified as enumerations.
- d) <<MetaClass>> A class whose instances are classes. Metaclasses are typically used in the construction of metamodels. The meaning of metaclass is an object class whose primary purpose is to hold metadata about another class. For example, “FeatureType” and “AttributeType” are metaclasses for “Feature” and “Attribute”.
- e) <<DataType>> A descriptor of a set of values that lack identity (independent existence and the possibility of side effects). Data types include primitive predefined types and user-definable types. A DataType is thus a class with few or no operations whose primary purpose is to hold the abstract state of another class for transmittal, storage, encoding or persistent storage.
- f) <<Codelist>> A data type whose instances form a list of named literals, some or all of whose members may not be known. The **Codelist** name is declared in the application schema. The list members may be described by either (i) a list of codes and corresponding literals augmented with a pattern allowing additional values conforming to a certain format, or (ii) a pointer to a resource consisting of a list of code/literal mappings. The resource is called a vocabulary or dictionary. Tagged values attached to the **Codelist** declaration indicate which form is used and the location of the resource (generally as a URI). Codelists should be used only when an enumeration is either unusable or inefficient (e.g., if the full list of values is not known to the specification authors or the list of allowed values is long, volatile, controlled by another authority, and/or shared by multiple domains).

### 1-4.11 Optional, conditional and mandatory – attributes and associations

In UML all attributes are per default mandatory. The possibility to show multiplicity for attributes and association role names provide a way of describing optional and conditional attributes.

The default is mandatory which thus do not need to be specified. Where a multiplicity of 0..1 or 0..\* is specified it means that this attribute may be present or may be omitted. A conditional attribute shall be shown as an optional attribute with a constraint statement in OCL. The condition shall be expressed as an OCL constraint in connection with the class declaration. This mean that a null value must be represented in the instance model, e.g.: a place holder element or a null value. An optional or conditional attribute shall never have a default value defined.

An attribute may be defined as conditional, meaning that it is optional depending on other attributes. The dependencies may be by existence-dependence of other (optional) attributes or by the values of other attributes. A conditional attribute is shown as optional with a conditional expression attached. The condition shall be written in a note directly associated with the attribute, or with the class and the name of the attribute on the first line. A conditional attribute shall never have a default value defined.

If unspecified, the default multiplicity for associations is 0..\*, and the default multiplicity for attributes is 1.

### 1-4.12 Naming and name spaces

All classes shall have unique names. All classes shall be defined within a package. Class names shall start with an upper case letter. A class shall not have a name that is based on its external usage, since this may limit reuse. A class name shall not contain spaces. Separate words in a class name shall be concatenated. Each subword in a name shall begin with a capital letter, such as "XnnnYmmm".

To ensure global uniqueness of class names, all class names shall be defined with bi-alpha prefixes. Bialpha prefixes allows for the use of \_ after, such as in GM\_Object. The geometry model uses bialpha prefixes (GM and TP). Other prefixes should be defined for other areas.

The name of an association must be unique within the context of a class and its supertypes or else it must be derived.

Attribute names shall start with a lower-case letter.

Example: firstName, lastName.

Precise technical names should be used for attributes and operations to avoid confusion.

Example: alphaCodeIdentifier, dateOfLastChange

Documentation fields should be used extensively to describe element.

Don't reiterate class names inside the attribute names. Keep names short if possible.

Example: class S-100\_WorkingGroup, attribute workingGroupName.

Naming conventions are used for a variety of reasons, mainly readability, consistency and as a protection against case-sensitive binding.

The names of UML elements should:

- 1) Use precise and understandable technical names for classes, attributes.

Example: index not i

- 2) For attributes and association roles capitalize only the first letter of each word after the first word that is combined in a name. Capitalize the first letter of the first word for each name of a class, package, type-specification and association names.

Example: computePartialDerivatives (not computepartialderivatives or COMPUTEPARTIALDERIVATIVES)

Example: CoordinateTransformation (not coordinateTransformation)

- 3) Keep names as short as practical. Use standard abbreviations if understandable, skip prepositions, and drop verbs when they do not significantly add to meaning of the name.
  - numSegment instead of numberOfSegments
  - Equals instead of IsEqual
  - value() instead of getValue()
  - initObject instead of initializeObject
  - length() instead of computeLength()

The UML naming scope with package::package::className allows for the same className to be defined in different packages. However, many UML tools do not currently allow for this. Therefore, a more restrictive naming convention is adopted:

- 1) Although the model is case sensitive, all class name should be unique in a case insensitive manner.
- 2) Class name should be unique across the entire model (so as not to create a problem with many UML tools).
- 3) Package names should be unique across the entire model. (for the same reason).
- 4) Every effort should be applied to eliminate multiple classes instantiating the same concept.

#### 1-4.13 Notes

Note boxes are used to comment on the model in general or on a specific item (i.e. class or association) of the model.



Figure 1-14 — Example note

#### 1-4.14 Packages

A UML package is a container that is used to group declarations of subpackages, classes and their associations. The package structure in UML enables a hierarchical structure of subpackages, class declarations, and associations. A package shall be used to represent a schema.

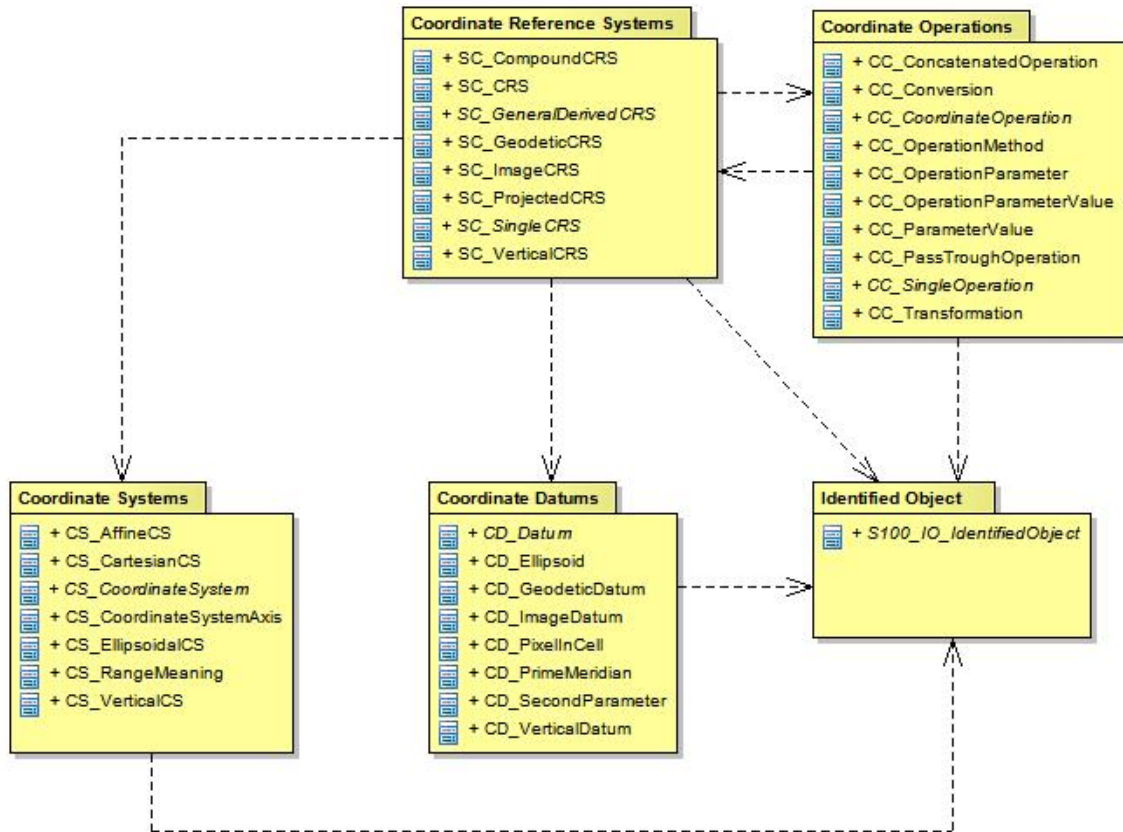


Figure 1-15 — Example package structure

The packages, classes and attributes in the schema model can be identified by a qualified name. The form of the qualified names is *name1* : :*name2* : :*name3*, where *name1* is the name of the outermost package, *name2* is a name which appears within the namespace of *name1*, and *name3* is a name that appears within the namespace of *name2*. The standard UML “: :” symbol shall be used as a name separator. There is no limit of the depth of this namespace hierarchy.

EXAMPLE In the Spatial schema there is a subpackage named Geometry which defines a class named GM\_Object. This class has an association with role name SRS (Spatial Reference System). The fully qualified name for this association is: Spatial.Geometry : :GM\_Object.SRS.

### 1-4.15 Documentation of models in S-100

In addition to the diagrams, it is necessary to document the semantics of the model. The meaning of attributes, associations, operations and constraints needs to be explained. This is done by means of context tables. A context table is defined for each class; it has the following columns:

- Role Name
- Name
- Description
- Multiplicity
- Data Type
- Remarks

The Role Name column specifies what property of the class is described in this row. Possible values are:

- Class – The class itself
- Attribute – An attribute of that class
- Association – An association to another class
- Enumeration – An enumerated data type
- Literal – A value of an enumerated data type

The Name column contains the name of the property. For association this is the role name used for the given class. In the Description column the semantics of the property are given. The Multiplicity column contains the number of occurrences of the property in the class. This also describes which properties are mandatory and which are optional. The Data Type column contains the name of the data type of the property. In the Remarks column additional information about the property can be expressed. This includes constraints or conditions. For the documentation of enumerated types the Multiplicity and Data Type column are not used.

The following example illustrates the use of context tables:

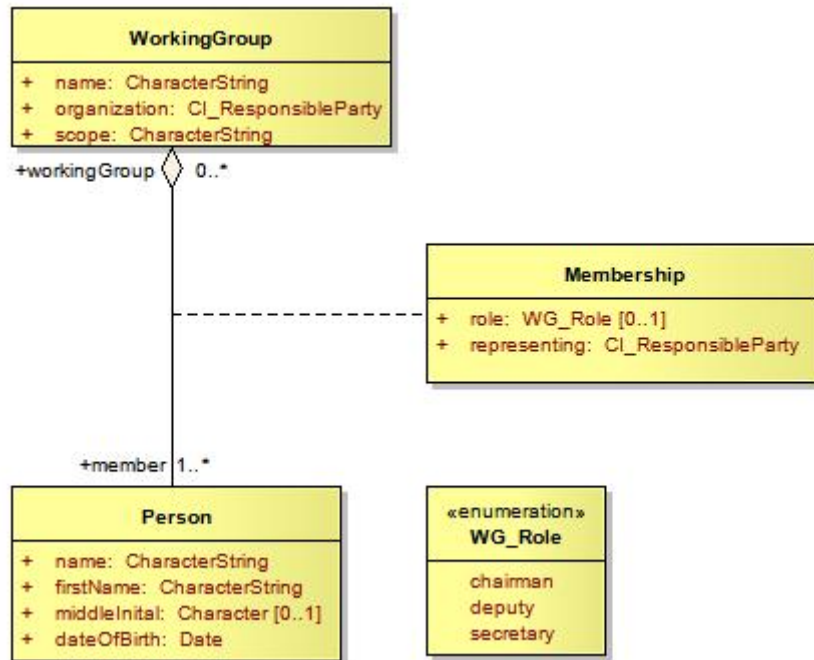


Figure 1-16 — Use of context tables

Role Name	Name	Description	Multiplicity	Data Type	Remarks
Class	WorkingGroup	A group of experts doing some useful work	-	-	
Attribute	name	The name of the working group	1	CharacterString	
Attribute	organization	The organization responsible for the working group	1	CI_ResponsibleParty	
Attribute	scope	The reason why so many people travel around the world	1	CharacterString	
Association	member	A person that is designated to contribute to the group	1..*	Person	

Role Name	Name	Description	Multiplicity	Data Type	Remarks
Class	Person	A human being	-	-	
Attribute	name	The name of the person	1	CharacterString	
Attribute	firstName	The first name of the person	1	CharacterString	
Attribute	middleInitial	The middle initial of the person	0..1	Character	
Attribute	dateOfBirth	The date when the person was born	1	Date	
Association	workingGroup	A working group the person contributes to	0..*	WorkingGroup	

Role Name	Name	Description	Multiplicity	Data Type	Remarks
Class	Membership	A class describing the membership of a person in a working group	-	-	
Attribute	role	The role that the person has in the working group	0..1	WG_Role	Ordinary member have no role
Attribute	representing	The organization which is represented by the person in the working group	1	CI_ResponsibleParty	

Role Name	Name	Description	Remarks
Enumeration	WG_Role	The roles people can have in a working group	
Literal	chairman	The gov'nor	
Literal	deputy	His best friend	
Literal	secretary	Poor man (or woman) has to have his (or her) fingers always on the keyboard	



# **S-100 – Part 2**

## **Management of Registers**

## Contents

2-1	Scope .....	1
2-2	Conformance .....	1
2-3	Normative references .....	1
2-4	General concepts .....	2
2-4.1	Registry .....	2
2-4.2	Register .....	2
2-5	Roles and responsibilities in the management of registers.....	2
2-5.1	Register Owner .....	2
2-5.2	Register Manager.....	2
2-5.3	Register User .....	3
2-5.4	Control Body.....	3
2-5.5	Submitting Organizations .....	3
2-5.6	Processing of Proposals.....	3
2-6	The Register Manager shall .....	3
2-6.1	Proposal legitimacy .....	4
2-6.2	List of submitting organizations .....	8
2-6.3	Publication.....	8
2-6.4	Integrity.....	9
2-7	Register Schema.....	9
2-7.1	Introduction.....	9
2-7.2	S100_RE_Register.....	10
2-7.3	S100_RE_RegisterItem.....	10
2-7.4	RE_ItemStatus .....	11
2-7.5	S100_RE_ReferenceSource.....	12
2-7.6	RE_SimilarityToSource .....	13
2-7.7	S100_RE_Reference .....	13
2-7.8	S100_RE_ManagementInfo.....	15
2-7.9	RE_DecisionStatus .....	16
2-7.10	S100_RE_ProposalType.....	16
2-7.11	RE_Disposition.....	17

## 2-1 Scope

This part of S-100 specifies procedures to be followed in maintaining and publishing registers of unique, unambiguous and permanent identifiers that are assigned to items of geographic, hydrographic and metadata information. In order to accomplish this purpose, this part describes the roles and responsibilities for the management of a registry and its registers. Specific administrative details of the IHO Geospatial Information Registry and registers is documented in IHO Publication S-99.

## 2-2 Conformance

This profile conforms to level 2 of ISO 19106:2004. The following is a brief description of the specializations and generalizations where the profile differs from ISO 19135:2005.

- 1) S100\_RE\_Register constrains the use of the attribute alternativeLanguages.
- 2) S100\_RE\_RegisterItem constrains the use of the attributes fieldOfApplication and alternativeExpression.
- 3) S100\_RE\_RegisterItem renames the attribute description to remarks.
- 4) S100\_RE\_ManagementInfo is a new class which amalgamates the classes RE\_DecisionStatus, S100\_RE\_ProposalType, S100\_RE\_SubmittingOrganization, RE\_ItemStatus and RE\_Disposition.
- 5) S100\_RE\_ProposalType is a new class which amalgamates the 19135 classes RE\_AdditionInformation, RE\_ClarificationInformation, RE\_AmendmentInformation and RE\_AmendmentType.

## 2-3 Normative references

ISO 19135:2005, Geographic Information – Procedures for registration of items of geographic information.

ISO 8601:2004, Data elements and interchange formats - Information interchange – Representation of dates and times.

IHO S-99:2012, Operational Procedures for the Organization and Management of the S-100 Geospatial Information Registry.

## **2-4 General concepts**

### **2-4.1 Registry**

A registry is the information system on which a register is maintained.

#### **2-4.1.1 Registry Owner**

A Registry Owner has the authority to host the registers and establish the policy for access. The Registry Owner decides whether a proposed register shall be hosted on the registry.

#### **2-4.1.2 Registry Manager**

The Registry Manager is responsible for the day-to-day operation of the registry. This includes:

- 1) providing registry access for Register Managers, Control Bodies, and Register Users
- 2) ensuring that information about items in the Registers is readily available to users in relation to those items that are valid, superseded, or retired
- 3) accepting proposals and forwarding them to all Register Managers
- 4) managing the resolution of persistent URI identifiers to appropriate resources, but only if resolution services are provided on a registry server.

### **2-4.2 Register**

A register is simply a managed list. It is easier to maintain than a fixed document, because new items can be added as needed to the register, and existing items in the register can be clarified, superseded or retired. Each register item has one or more dates associated with it that indicate when changes in its status occurred. This means that a product specification, defined at a given date, may reference an item in the register at a specific point in time.

## **2-5 Roles and responsibilities in the management of registers**

### **2-5.1 Register Owner**

The Register Owner is an organization that:

- 1) Establishes one or more registers
- 2) Has primary responsibility for the management, dissemination, and intellectual content of those registers
- 3) May appoint another organization to serve as the register manager
- 4) Shall establish a procedure to process proposals and appeals made by submitting organizations.

### **2-5.2 Register Manager**

The Register Manager is responsible for the administration of a register. This includes:

- 1) Coordinating with other Register Managers, Submitting Organizations, the related Control Body, Register Owner and the Registry Manager
- 2) Maintaining items within the register
- 3) Maintain and publish a List of Submitting Organizations
- 4) Distributing an information package containing a description of the register and how to submit proposals
- 5) Providing periodic reports to the Register Owner and/or the Control Body. Each report shall describe the proposals received and the decisions taken since the last report. The interval between those reports must not exceed 12 months

A Register Manager may manage multiple registers.

### **2-5.3 Register User**

A Register User is any person or organization interested in accessing or determining the content of a register.

### **2-5.4 Control Body**

A Control Body is a group of technical experts appointed by a Register Owner to decide on the acceptability of proposals for changes to the content of a register. The group must comprise of experts in the related field that makes up the contents of the register.

### **2-5.5 Submitting Organizations**

#### **2-5.5.1 Eligible submitting organizations**

A submitting organization is an organization that is qualified under criteria determined by the register owner to propose changes to the content of a register. The register manager shall determine whether a submitting organization is qualified in accordance with the criteria established by the register owner.

### **2-5.6 Processing of Proposals**

#### **2-5.6.1 Introduction**

Submitting organizations may submit requests for addition, clarification, supersession, and retirement of registered items.

#### **2-5.6.2 Addition of registered items**

Addition is the insertion into a register of an item that describes a concept not adequately described by an item already in the register.

#### **2-5.6.3 Clarification of registered items**

Clarifications correct errors in spelling, punctuation, grammar or improvements to content or wording. A clarification shall not cause any substantive semantic change to a registered item. The three characteristics that can be clarified are definition, other references, and remarks.

#### **2-5.6.4 Supersession of registered items**

Supersession of an item means any proposal that would result in a substantive semantic change to an existing item. Supersession shall be accomplished by including one or more new items in the register with new identifiers and a more recent date. The original item shall remain in the register but shall include the date at which it was superseded, and a reference to the items that superseded it.

#### **2-5.6.5 Retirement of registered items**

Retirement shall be effected by leaving the item in the register, marking it retired, and including the date of retirement.

### **2-6 The Register Manager shall**

- 1) receive proposals from submitting organizations
- 2) review proposals for completeness
- 3) return proposals to the submitting organization if incomplete.
- 4) check within the register for similar proposals, and if similar, the register manager shall contact the submitting organizations
- 5) coordinate proposals with other register managers within two calendar weeks from the date received
- 6) generate a proposal management record, with the status set to 'pending';
- 7) and initiate the approval process

## 2-6.1 Proposal legitimacy

The Register Manager shall use the following criteria to determine if the proposal is complete and reject the proposal if:

- 1) the submitter is not a qualified submitting organization
- 2) the proposed item does not belong to an item class assigned to this register manager
- 3) the proposed item does not fall within the scope of the Register
- 4) the proposed item has already been proposed

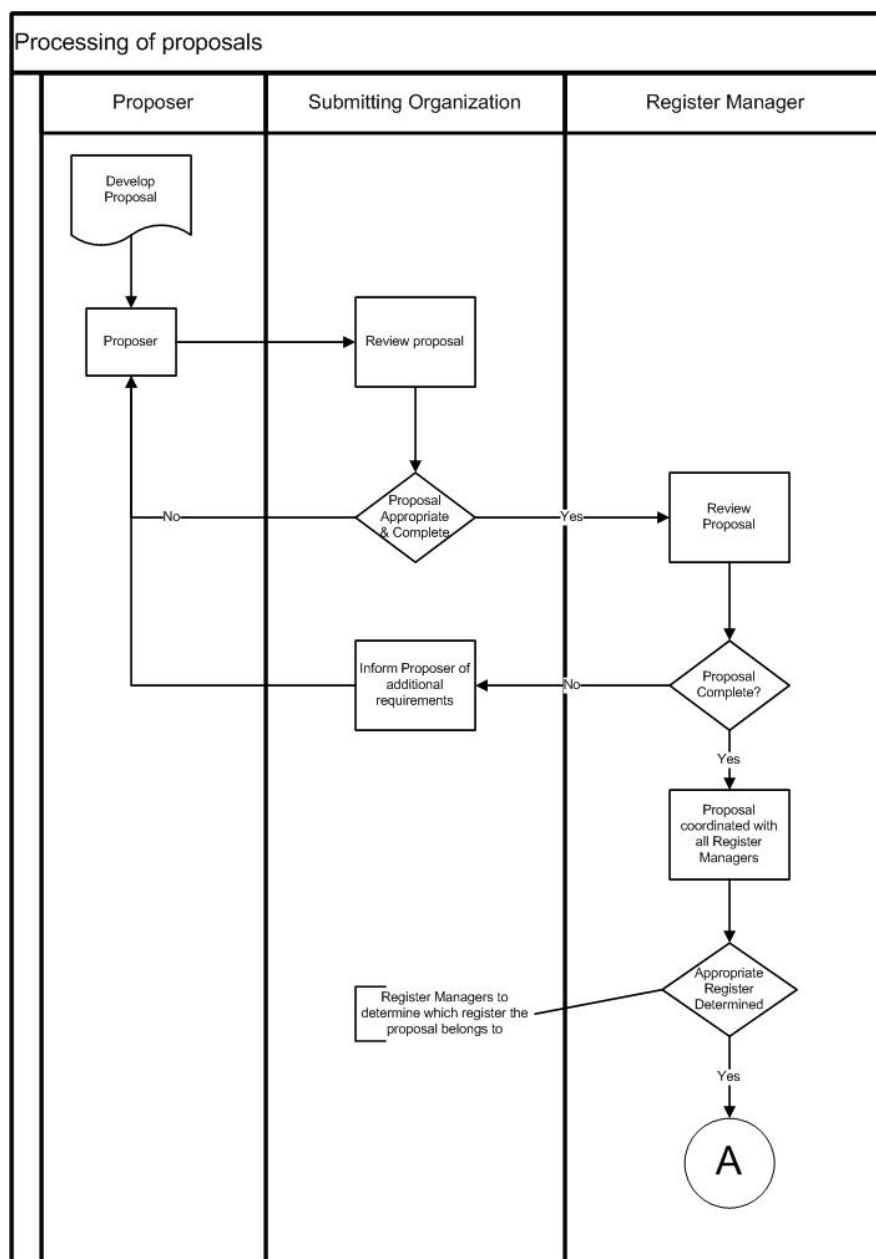


Figure 2-1 – Proposal process

### 2-6.1.1 Approval process

The process for determining the acceptability of proposals is illustrated in Figure 2-2. It shall be completed within a time period specified by the register owner.

The register manager shall ensure the following:

- 1) If the proposal is for clarification or retirement of a register item, forward the proposal to the control body; or
- 2) if the proposal is for registration of a new item or supersession of an existing register item:
  - a) assign an *itemIdentifier* to the new or superseding item
  - b) set the *status* of the item to 'notValid'; and forward the proposal to the control body.

The control body shall:

- 1) decide to accept the proposal without change, to accept the proposal subject to changes negotiated with the submitting organization, or not to accept the proposal. Criteria for not accepting a proposal include:
  - a) the specification of the item is incomplete or incomprehensible;
  - b) an identical or very similar item already exists in the register or in another register of this registry;
  - c) the proposed item does not belong to an item class included in this register;
  - d) the proposed item does not fall within the scope of this Register; or
  - e) the justification for the proposal is inadequate.
- 2) inform the register manager of the decision, and the rationale for the decision, within a time limit specified by the register owner.

The register manager shall:

- 1) serve as the point of contact if there is a need for negotiations between the submitting organization and the control body regarding changes to the proposal that are specified by the control body as a condition of acceptance; and
- 2) inform the submitting organization of the results of processing a proposal.
- 3) If the decision of the control body is positive, the register manager shall in accordance with policies for this register:
  - a) complete the proposal management record with *status* set to 'final', *disposition* set to 'accepted', and *dateDisposed* to the date of the control body's decision;
  - b) make approved changes to the content of the register item;
  - c) set the Register item *status* to 'valid', 'superseded', or 'retired', as appropriate.
- 4) If the decision of the control body is negative:
- 5) update the proposal management record by setting *status* to 'tentative', *disposition* to 'notAccepted', and *dateDisposed* to the date of the control body's decision; and
  - a) inform the submitting organization of the deadline for appealing the decision of the control body.
  - b) Disseminate the results of the approval process to the public.

Submitting organizations shall:

- 1) negotiate with the control body through the Register Manager, with regard to changes to their proposal that are specified by the control body as a condition of acceptance; and
- 2) make known within their respective communities or organizations the decisions taken on proposals by the control body as transmitted to them by the register manager.

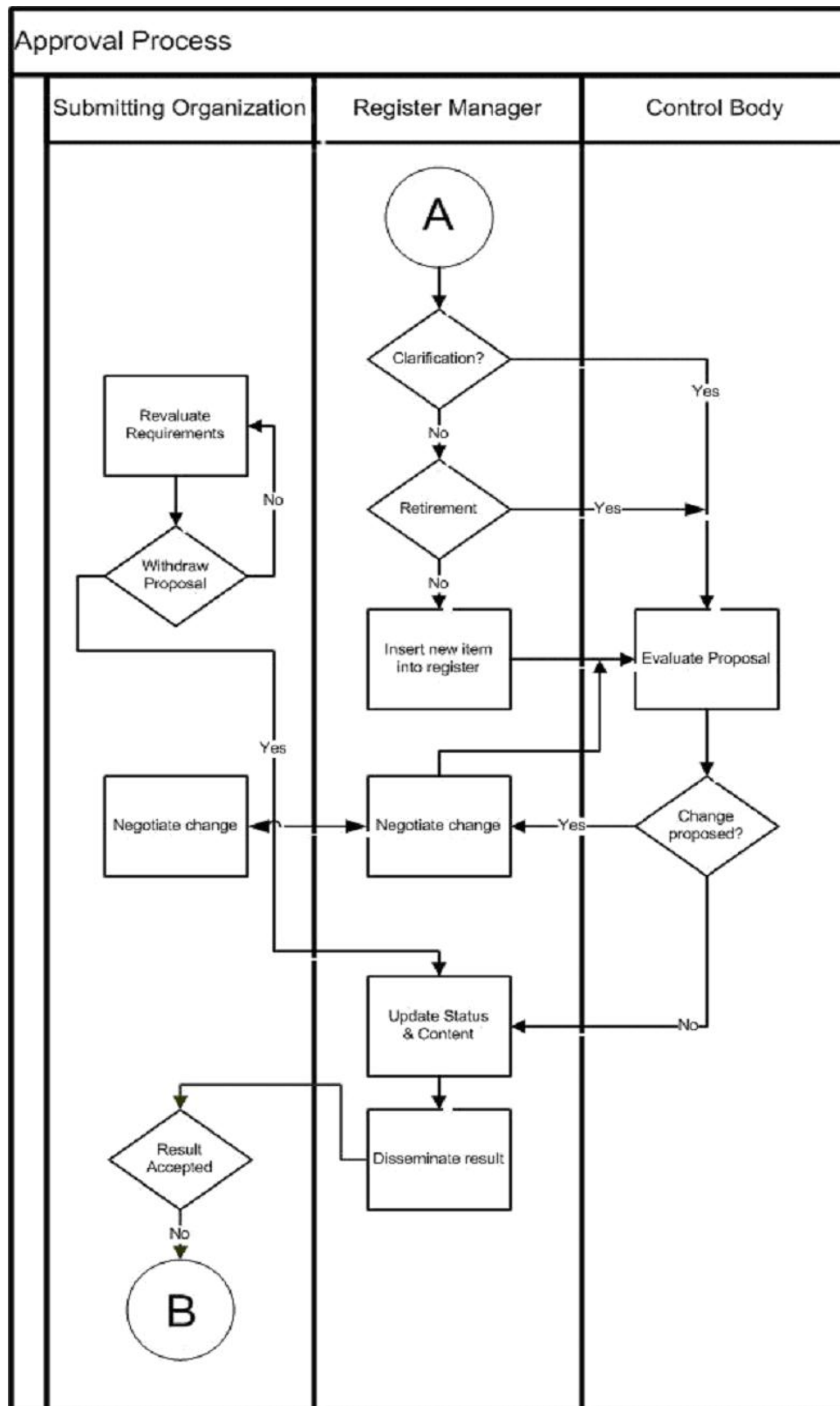


Figure 2-2 – Approval process



### 2-6.1.2 Withdrawal

Submitting organizations may decide to withdraw a proposal at any time during the approval process.

The Register Manager shall:

- 1) change the proposal management *status* from 'pending' to 'final'; and
- 2) change the proposal management *disposition* to 'withdrawn' and the value for *dateDisposed* to the current date.

### 2-6.1.3 Appeals

A submitting organization may appeal to the register owner if it disagrees with the decision of a control body to reject a proposal for addition, clarification, retirement, or supersession of an item in a register. An appeal shall contain at a minimum a description of the situation, a justification for the appeal, and a statement of the impact if the appeal is not successful. The appeal process is illustrated in Figure 2-3.

The submitting organization shall:

- 1) determine if the decision regarding a proposal for registration is acceptable; and
- 2) if not, submit an appeal to the register manager.

The register manager shall:

- 1) forward the appeal to the register owner.

If there is no appeal by the deadline for submitting an appeal, the register manager shall change the *status* of the proposal management record to 'final' and change the *dateDisposed* to the current date.

The register owner shall:

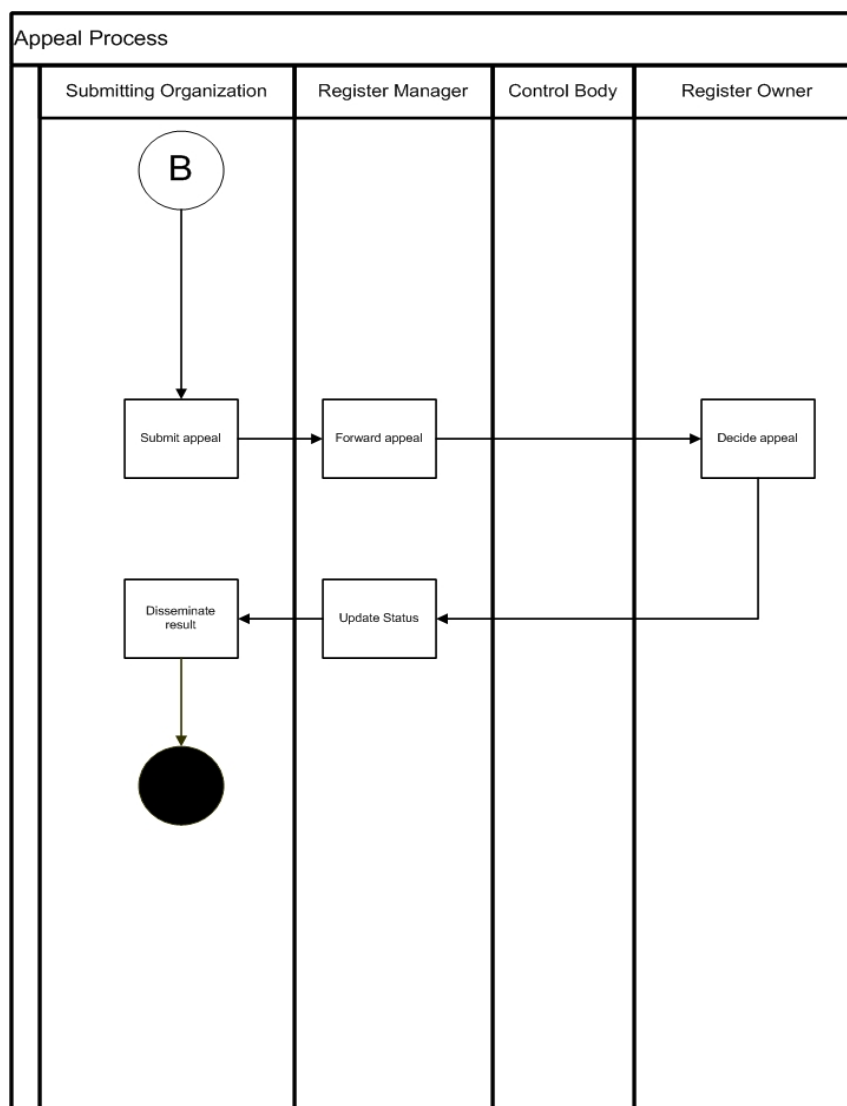
- 1) process the appeal in conformance with its established procedures ; and
- 2) decide whether to accept or reject the appeal.
- 3) return the result to the register manager

The register manager shall:

- 1) update the proposal management record fields *disposition* and *dateDisposed*;
- 2) update the register item *status*; and
- 3) provide the results of the decision to the control body and to the submitting organization.

The submitting organization shall:

- 1) make the results of the appeal known within their community or organization.



**Figure 2-3 – Appeal process**

## 2-6.2 List of submitting organizations

The register manager shall maintain and publish a register-specific list of all qualified submitting organizations that may submit proposals for changes to the content of each register that it manages. Each list shall include the name and contact information for each submitting organization. The registry shall contain an application to become a submitting organization. The register owner will be responsible for accepting or rejecting the application.

## 2-6.3 Publication

The registry manager shall ensure that information about valid, superseded, or retired items in the register is readily available to users. The method for providing this information may depend upon the requirements of the members of the user community.

## 2-6.4 Integrity

The register manager shall ensure that, for each register being managed:

- 1) all aspects of the registration process are handled in accordance with good business practice,
- 2) the content of the register is accurate, and
- 3) only authorised persons can make changes to the register content.

The registry manager shall ensure the security and integrity of the registry using IT best practices.

## 2-7 Register Schema

### 2-7.1 Introduction

The schema specified in this clause describes the structure of an IHO Geospatial Information Register.

Information about the register and items in the register shall be:

- 1) accessible through an on-line interface to the register;
- 2) included in any copy of the register; and
- 3) included in any information package about the register.

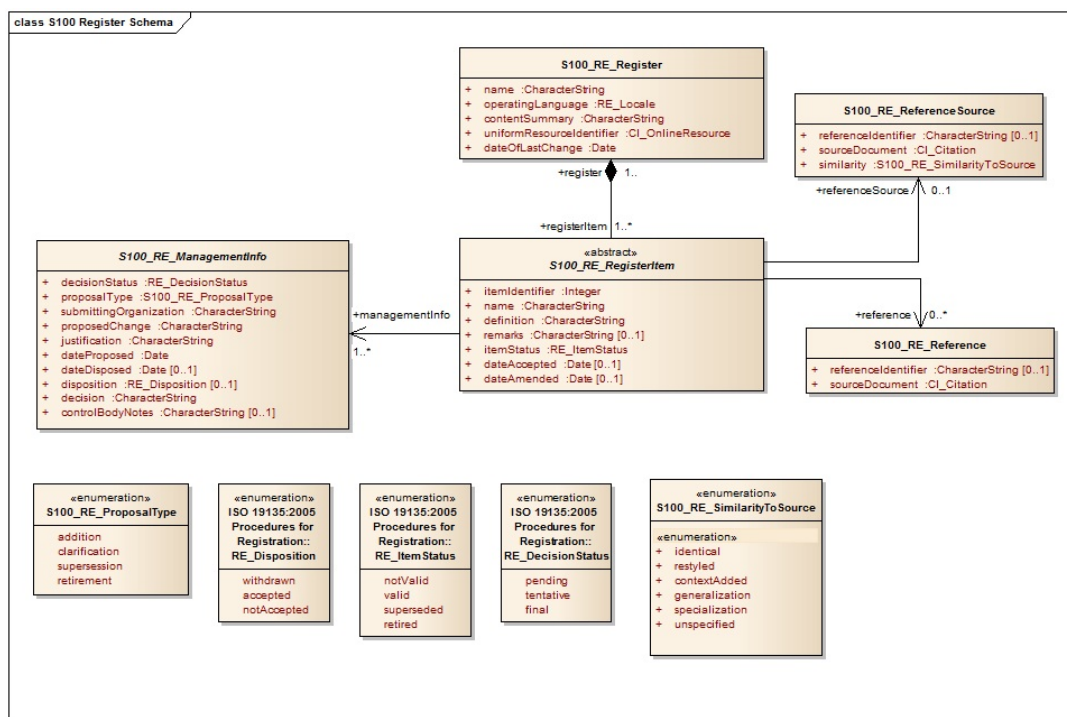


Figure 2-4 – The register schema

## 2-7.2 S100\_RE\_Register

The class S100\_RE\_Register specifies information about the register itself.

Role Name	Name	Description	Mult	Data Type	Remarks
Class	S100_RE_Register		-	-	
Attribute	name	The name of the register	1	CharacterString	Unique within the registry
Attribute	operatingLanguage	The language used in this register	1	RE_Locale	
Attribute	contentSummary	Summary of the content	1	CharacterString	
Attribute	uniformResourceIdentifier	The link to the interface of the register in the Internet	1	CI_OnlineResource	
Attribute	dateOfLastChange	The date when the last change was made to this register	1	Date	
Association	registerItem	The items of the register	1..*	S100_RE_RegisterItem	

## 2-7.3 S100\_RE\_RegisterItem

The class S100\_RE\_RegisterItem carries the characteristics that are common to all types of registered items. Domain specific extensions may be added in the appropriate part of S-100 e.g. Part 2a – Feature Concept Dictionary.

Role Name	Name	Description	Mult	Data Type	Remarks
Class	S100_RE_RegisterItem		-	-	Class is abstract
Attribute	itemIdentifier	Each item has its own unique identifier in a register	1	Integer	
Attribute	name	Succinct expression of the item concept it denotes	1	CharacterString	
Attribute	definition	Shall be a precise statement of the nature, properties, scope, or essential qualities of the concept as realized by the item.	1	CharacterString	
Attribute	remarks	Supplementary information	0..1	CharacterString	remarks
Attribute	itemStatus	The state in which a registered item exists	1	RE_ItemStatus	

Role Name	Name	Description	Mult	Data Type	Remarks
Attribute	dateAccepted	The date a registered item became valid	0..1	Date	
Attribute	dateAmended	The date a registered item is clarified, superseded or retired	0..1	Date	
Association	register	The register that contains the item	1	S100_RE_Register	
Association	referenceSource	The source information the item definition was taken from.	0..1	S100_RE_ReferenceSource	
Association	reference	Reference to other relevant standards or documents	0..*	S100_RE_Reference	For example INT1 or M4
Association	managmentInfo	Sets of information describing the management of the item in the register	1..*	S100_RE_ManagmentInfo	

## 2-7.4 RE\_ItemStatus

The enumeration RE\_ItemStatus identifies the registration status of a register item.

Role Name	Name	Description	Remarks
Enumeration	RE_ItemStaus		
Literal	notValid	The item has been entered into the register, but the control body has not accepted the proposal to add it.	
Literal	valid	The item has been accepted, is recommended for use, and has not been superseded or retired.	
Literal	superseded	The item has been superseded by one or more items and is no longer recommended for use.	
Literal	retired	A decision has been made that the item is no longer recommended for use. It has not been superseded by another item.	

## 2-7.5 S100\_RE\_ReferenceSource

The class S100\_RE\_ReferenceSource specifies information about the source of a register item specifications taken from an external document or register.

Role Name	Name	Description	Mult	Data Type	Remarks
Class	S100_RE_ReferenceSource		-	-	
Attribute	referenceIdentifier	An identifier of the place in the source document that is referenced	0..1	CharacterString	
Attribute	sourceDocument	The source document.	1	CI_Citation	
Attribute	similarity	Indicates how the definition is related to the source document	1	S100_RE_SimilarityToSource	

## 2-7.6 S100\_RE\_SimilarityToSource

The enumeration S100\_RE\_SimilarityToSource identifies the type of change that has been made to an item specification relative to an item specification in an external source.

Role Name	Name	Description	Remarks
Enumeration	S100_RE_SimilarityToSource		
Literal	identical	No change has been made to the definition.	
Literal	restyled	The style of the definition has been changed to match the style and structure of other definitions in the register that has imported the definition.	
Literal	contextAdded	The definition includes information about its context that is not explicit in the specification in the external source.	
Literal	generalization	The definition of the register item has been generalized to have a broader meaning than the item specified in the external source.	
Literal	specialization	The definition of the register item has been specialized to have a narrower meaning than the item specified in the external source.	
Literal	unspecified	The nature of the differences between the register item and the similar item in the external source is unspecified.	

## 2-7.7 S100\_RE\_Reference

The class S100\_RE\_Reference specifies information about the source and/or lineage of a specific register item derived from an external document or register.

Role Name	Name	Description	Mult	Data Type	Remarks
Class	S100_RE_Reference		-	-	
Attribute	referenceIdentifier	An identifier of the place in the source document that is referenced	0..1	CharacterString	
Attribute	sourceDocument	The source document.	1	CI_Citation	





## 2-7.8 S100\_RE\_ManagementInfo

The class S100\_RE\_ManagementInfo specifies the management record of a register item.

Role Name	Name	Description	Mult	Data Type	Remarks
Class	S100_RE_ManagementInfo		-	-	
Attribute	decisionStatus	The current status of a proposal	1	RE_DecisionStatus	
Attribute	proposalType	The type of the proposal.	1	S100_RE_ProposalType	
Attribute	submittingOrganisation	The proposal's sponsor.	1	CharacterString	
Attribute	proposedChange	The text of the proposed change	1	CharacterString	
Attribute	justification	Primary reason for the proposal including how it is proposed to be used	1	CharacterString	
Attribute	dateProposed	Date the proposal was made.	1	Date	
Attribute	dateDisposed	Date the proposal was adjudicated	1	Date	
Attribute	disposition	Provides values for describing the disposition of a proposal to add or modify a register item.	1	RE_Disposition	
Attribute	decision	decision comments	1	CharacterString	
Attribute	controlBodyNotes	supplementary management information	0..*	CharacterString	

### 2-7.9 RE\_DecisionStatus

The enumeration RE\_DecisionStatus specifies the status of a register item.

Role Name	Name	Description	Remarks
Enumeration	RE_DecisionStatus	Possible values for a decision	
Literal	Pending	No decision has been made.	
Literal	Tentative	A decision has been made, but it is still subject to appeal.	
Literal	Final	A decision has been made and the time limit for appeal has run out or an appeal has been resolved.	

### 2-7.10 S100\_RE\_ProposalType

The enumeration S100\_RE\_ProposalType species the type of proposal for a register item.

Role Name	Name	Description	Remarks
Enumeration	S100_RE_ProposalType		
Literal	Addition	The item is to be added to the register	
Literal	Clarification	A non-substantive change to an item in the register	
Literal	Supersession	The item has been superseded by another item and is no longer recommended for use.	
Literal	Retirement	A decision has been made that the item is no longer recommended for use. It has not been superseded by another item	

### 2-7.11 RE\_Disposition

The enumeration RE\_Disposition specifies the disposition of a proposal to add or change a register item.

Role Name	Name	Description	Remarks
Enumeration	RE_Disposition		
Literal	withdrawn	The submitting organization has withdrawn the proposal.	
Literal	accepted	The control body decided to accept the proposal.	
Literal	notAccepted	The control body decided not to accept the proposal.	

# **S-100 – Part 2a**

## **Feature Concept Dictionary Registers**

## Contents

2a-1	Scope .....	1
2a-1.1	Conformance.....	1
2a-2	Normative references.....	1
2a-3	General concepts .....	2
2a-3.1	Register.....	2
2a-3.2	Feature concept dictionary.....	2
2a-3.3	Feature catalogue .....	2
2a-4	IHO Feature Concept Dictionary.....	2
2a-4.1	Types of registered items.....	2
2a-4.2	Data model of a Feature Concept Dictionary.....	3
2a-4.2.1	UML Model.....	3
2a-4.2.2	S100_RE_Register .....	4
2a-4.2.3	S100_CD_RegisterItem .....	4
2a-4.2.4	RE_ItemStatus .....	4
2a-4.2.5	S100_CD_FeatureConcept.....	5
2a-4.2.6	S100_CD_FeatureUseType.....	5
2a-4.2.7	S100_CD_AttributeConcept.....	5
2a-4.2.8	S100_CD_SimpleAttributeConcept.....	6
2a-4.2.9	S100_CD_QuantitySpecification.....	6
2a-4.2.10	S100_CD_AttributeValueType .....	8
2a-4.2.11	S100_CD_AttributeConstraints .....	9
2a-4.2.12	S100_CD_ComplexAttributeConcept .....	9
2a-4.2.13	S100_CD_AttributeUsage.....	10
2a-4.2.14	S100_CD_EnumeratedValueConcept .....	10
2a-4.2.15	S100_CD_InformationConcept .....	11
2a-4.2.16	S100_CD_AlphaCode.....	11
2a-4.2.17	S100_RE_ReferenceSource.....	12
2a-4.2.18	S100_RE_Reference .....	12
2a-4.2.19	S100_RE_ManagementInfo.....	12
Appendix 2a-A	Example of a complex attribute .....	14

## 2a-1 Scope

The IHO registry will contain a number of registers, many of which will be Feature Concept Dictionaries (FCD). A feature concept dictionary specifies hydrographic definitions that may be used to describe geographic information. The use of a register to store hydrographic definitions will significantly improve the IHO's ability to manage and extend multiple products based on S-100 which can be made available for use in a relatively short timescale. This register will support wider use of registered items by making them publicly available and increase their visibility to potential users. This Part describes the content of the register and specifies procedures to be followed in establishing, maintaining, and publishing registers of unique, unambiguous and permanent identifiers that are assigned to items of geographic, hydrographic and metadata information. In order to accomplish this purpose, this Part specifies elements of information that are necessary to provide identification and definitions to the registered items.

### 2a-1.1 Conformance

This profile conforms to conformance class 2 of ISO 19106:2004. The following is a brief description of the specializations and generalizations where the profile differs from ISO 19126:2008.

- 1) A new class, S100\_CD\_InformationConcept is introduced.
- 2) New classes, S100\_CD\_FeatureBinding, S100\_CD\_InformationBinding and S100\_FC\_AttributeBinding are introduced.
- 3) A new class, S100\_CD\_AttributeConstraints is introduced.
- 4) The class FC\_FeatureAttribute is specialized to be the abstract class S100\_CD\_Attribute.
- 5) New classes, S100\_CD\_SimpleAttributeConcept and S100\_CD\_ComplexAttributeConcept are introduced.
- 6) A new class, S100\_CD\_InformationRole is introduced.
- 7) The classes CD\_InheritanceRelation, CD\_FeatureOperation CD\_Binding, CD\_Constraint and CD\_BoundFeatureAttribute are not used.

## 2a-2 Normative references

The following referenced documents are required for the application of this document. For dated references, only the edition cited applies. For undated references, the latest edition of the referenced document (including amendments) applies.

ISO 19135:2005, Geographic Information – Procedures for registration of items of geographic information

ISO/DIS 19126:2008, Geographic Information – Feature concept dictionaries and registers

ISO 8601:2004, Data elements and interchange formats - Information interchange - Representation of dates and times

RFC 3986, *Uniform Resource Identifier (URI): Generic Syntax*. T. Berners-Lee, R. Fielding, L. Masinter. Internet Standard 66, IETF. URL: <http://www.ietf.org/rfc/rfc3986.txt> or <http://www.rfc-editor.org/info/std66>

RFC 2141, *URN Syntax*. R. Moats. IETF RFC 2141, May 1997. URL: <http://www.rfc-editor.org/info/rfc2141>

## **2a-3 General concepts**

### **2a-3.1 Register**

As described in Part 2, a register is simply a managed list. It is easier to maintain than a fixed document, because new items can be added as needed to the register, and existing items in the register can be clarified, superseded or retired. Each register item has one or more dates associated with it that indicate when changes in its status occurred. This means that a product specification, defined at a given date, may reference an item in the register at that specific point in time.

### **2a-3.2 Feature concept dictionary**

A feature concept dictionary specifies independent sets of definitions of features, attributes, enumerated values, and information types that may be used to describe geographic, hydrographic, and metadata information. A feature concept dictionary may be used to develop a feature catalogue. Unlike a feature catalogue, a feature concept dictionary does not make associations or bind attributes to features.

Registers of feature information may serve as sources of reference for similar registers established by other geographic information communities as part of a system of cross-referencing.

### **2a-3.3 Feature catalogue**

A feature catalogue is a document that describes the content of a data product. It uses item types, for example, features and attributes, from one or more feature concept dictionaries and binds them together. In addition, constraints, units of measurement and format description of attributes can be specified. Feature Catalogues are described in detail in S-100 Part 5.

## **2a-4 IHO Feature Concept Dictionary**

### **2a-4.1 Types of registered items**

The following are types of items that may be registered.

- 1) Feature Concept – abstraction of real world phenomena.
- 2) Attribute Concept – characteristic of a feature concept.
- 3) Enumerated Value Concept – one of a set of mutually exclusive values constituting the domain of an attribute.
- 4) Information Concept– an identifiable object that contains attributes, associations to other information concepts, but no spatial information.
- 5) Codelist – an open enumeration, or the identifier of a vocabulary (mapping between codes, labels and definitions).

## 2a-4.2 Data model of a Feature Concept Dictionary

### 2a-4.2.1 UML Model

The following figure shows the information model of the hydrographic feature concept dictionary:

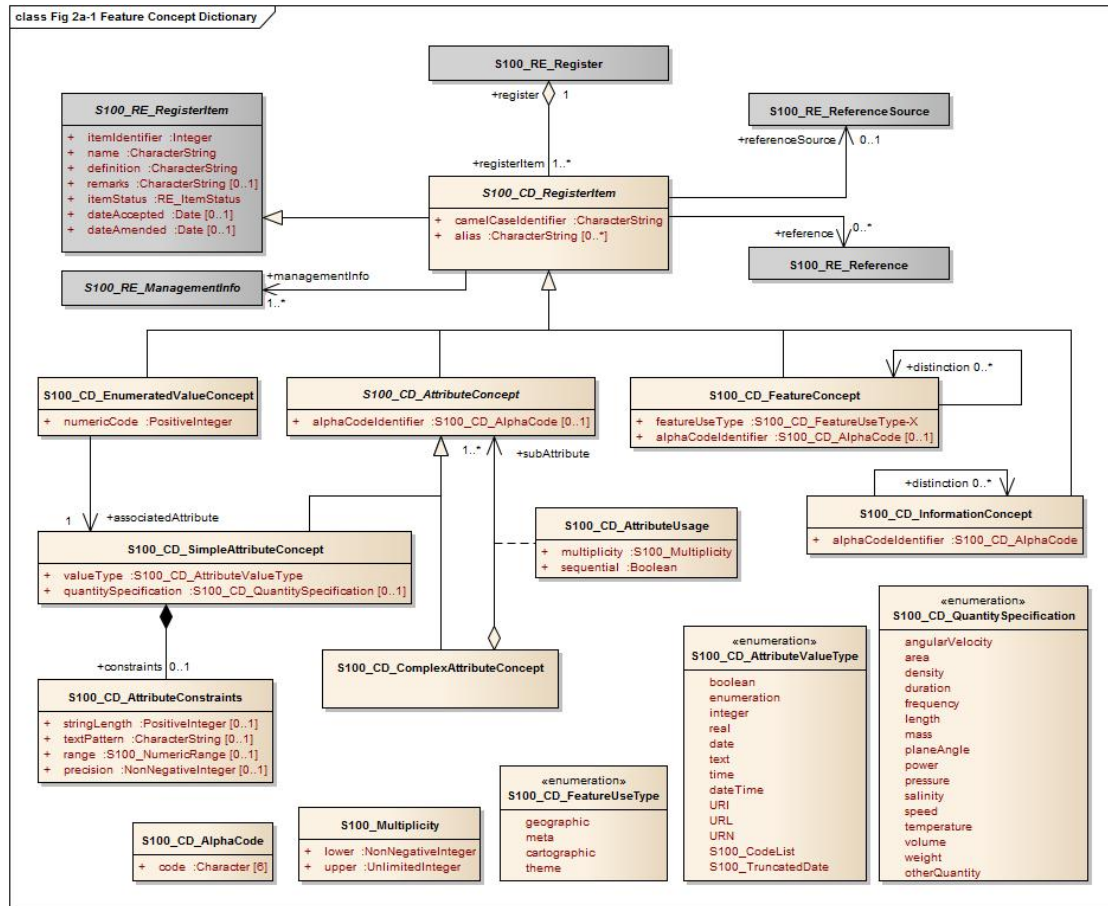


Figure 2a-1 – Feature Concept Dictionary



### 2a-4.2.2 S100\_RE\_Register

The class S100\_RE\_Register models a register in a feature concept dictionary. Further details can be found in S-100 Part 2.

### 2a-4.2.3 S100\_CD\_RegisterItem

The class S100\_CD\_RegisterItem is a specialization of the class S100\_RE\_RegisterItem and carries the characteristics that are common to all types of registered items listed in clause 2a-4.1

Role Name	Name	Description	Mult	Data Type	Remarks
Attribute	camelCaseIdentifier	Identifier of the item using camelCase notation.	1	CharacterString	See below
Attribute	alias	Equivalent name(s) used for the item	0..*	CharacterString	

The camelCaseIdentifier must:

- 1) be compound words in which the words are joined without spaces and are capitalized within the compound.
- 2) be unique within the registry.
- 3) conform to ISO 646 with uppercase characters A-Z, 0-9,"\_"; and lowercase characters a-z;
- 4) Features and Information types must begin with uppercase A-Z
- 5) Attributes and enumerated values must begin with lowercase a-z

Example 1 BeaconCardinal is the Camel Case identifier for the feature Beacon Cardinal.

Example 2 categoryOfLandmark is the Camel Case identifier for the attribute Category of Landmark

### 2a-4.2.4 RE\_ItemStatus

The class RE\_ItemStatus identifies the registration status of the S100\_CD\_RegisterItem. Further details can be found in S-100 Part 2.

### 2a-4.2.5 S100\_CD\_FeatureConcept

This class is derived from S100\_CD\_RegisterItem. It defines the following additional properties:

Role Name	Name	Description	Mult	Data Type	Remarks
Class	S100_CD_FeatureConcept	A feature type in a feature concept dictionary	-	-	Derived from S100_CD_RegisterItem
Attribute	featureUseType	The intended use of a feature type	1	S100_CD_FeatureUseType	
Attribute	alphaCodeIdentifier	Abbreviation designating the feature type	0..1	S100_CD_AlphaCode	See below.
Association role	distinction	references to feature types that this feature type is distinct from.	0..*	S100_CD_FeatureConcept	

### 2a-4.2.6 S100\_CD\_FeatureUseType

Role Name	Name	Description	Remarks
Enumeration	S100_CD_FeatureUseType	Categories of feature types	
Literal	geographic	carries the descriptive characteristics of a real world entity	
Literal	meta	Delineates geographic location where meta information is applicable" distinct from an Information Type which carries information related to features which are related.	
Literal	cartographic	carries information about the cartographic representation (including text) of a real world entity	
Literal	theme	Grouping features thematically.	

### 2a-4.2.7 S100\_CD\_AttributeConcept

Attributes may either be simple or complex. A simple attribute carries a specific value such as a date. A complex attribute is an aggregation of other attributes either simple or complex. Examples of complex attributes are in Appendix 2a-A. This class is derived from S100\_CD\_RegisterItem and describes the common characteristics of all attribute types.

Role Name	Name	Description	Mult	Data Type	Remarks
Class	S100_CD_AttributeConcept	Base class of all attribute types in a feature concept dictionary	-	-	Derived from S100_CD_RegisterItem Class is abstract
Attribute	alphaCodeIdentifier	Abbreviation designating the attribute type	0..1	S100_CD_AlphaCode	See below

### 2a-4.2.8 S100\_CD\_SimpleAttributeConcept

Role Name	Name	Description	Mult.	Data Type	Remarks
Class	S100_CD_SimpleAttributeConcept	A simple attribute type in a feature concept dictionary	-	-	Derived from S100_CD_AttributeConcept
Attribute	valueType	Describes representation, interpretation and structure of values	1	S100_CD_AttributeValueType	See below
Attribute	quantitySpecification	Specification of the quantity, e.g. length, volume, depth, weight etc.	0..1	S100_CD_QuantitySpecification	
Association	constraints	Constraints of the attribute type	0..1	S100_CD_AttributeConstraints	Must be consistent with dataType.

If the *valueType* is S100\_Codelist exactly one of the following must be true:

- 1) There is an associated S100\_RE\_Reference with the namespace of a dictionary that is listed in the GI Register.
- 2) There is at least one S100\_CD\_EnumeratedValueConcept associated to the attribute concept.

Condition 1 identifies the dictionary for codelists of type “open dictionary” or “closed dictionary.” Condition 2 provides the enumerated value(s) for codelists of type “open enumeration.” The precise codelist type is determined in individual product specifications.

### 2a-4.2.9 S100\_CD\_QuantitySpecification

Role Name	Name	Description	Remarks
Enumeration	S100_CD_QuantitySpecification	Types of quantity measures	Adapted from ISO 19103 Measure Types.
Literal	angularVelocity	The instantaneous rate of change of angular displacement with time.	From ISO 19103
Literal	area	The measure of the physical extent of any two-dimensional geometric object.	From ISO 19103
Literal	density	Mass per unit volume; number per unit area. Also: specific gravity (S-32). Density of soundings is the intervals between lines of sounding and soundings in the same line (S-32).	“Density” can be used in different senses, the unit of measure and attribute definition must make it clear which is intended.
Literal	duration	Interval of time	
Literal	frequency	Number of vibrations or cycles per unit time	IHO S-32

Literal	length	The longest dimension of an object; distance measured along a line or curve.	
Literal	mass	A numerical measure of the inertia of an object; the quantity of matter which a body contains, irrespective of its bulk or volume.	
Literal	planeAngle	The amount of rotation needed to bring one line or plane into coincidence with another, generally measured in radians or degrees.	From ISO 19103 "angle"
Literal	power	Rate of doing work or transferring energy; magnification.	S-32 refers "power" to "magnifying power: the ratio of the apparent length of a linear dimension as seen through an optical instrument to that seen by the unaided eye". The unit of measure and attribute definition must make it clear which sense is intended.
Literal	pressure	Force per unit area.	
Literal	salinity	A measure of the quantity of dissolved salts.	IHO S-32 (abbrev.)
Literal	speed	Rate of change of position with time.	Usually calculated using the simple formula, the change in position during a given time interval. Speed is a scalar physical quantity, having magnitude but not direction. Contrast to "velocity" which is a vector quantity having both magnitude and direction. (Adapted from ISO 19103 "velocity").
Literal	temperature	The intensity or degree of heat	IHO S-32
Literal	volume	The measure of the physical space of any 3-D geometric object.	From ISO 19103
Literal	weight	The force experienced by an object due to gravity.	
Literal	otherQuantity	A quantity different from the other literals of this enumeration.	

**2a-4.2.10 S100\_CD\_AttributeValueType**

Role Name	Name	Description	Remarks
Enumeration	S100_CD_AttributeValueType	Value types of simple attributes	
Literal	boolean	True or False	
Literal	enumeration	List of predetermined values that can be expanded and contracted.	
Literal	integer	numeric value with defined range, units and format.	
Literal	real	floating point number	
Literal	text	a sequence of characters	
Literal	date	character encoding shall follow the format for date as specified by ISO 8601	
Literal	time	character encoding shall follow the format for time as specified by ISO 8601	
Literal	dateTime	character encoding shall follow the format for date and time as specified by ISO 8601	
Literal	URI	character encoding shall follow the format for URI as specified by RFC 3986	
Literal	URL	character encoding shall follow the format for URL as specified by RFC 3986	
Literal	URN	character encoding shall follow the format for URN as defined by RFC 2141	
Literal	S100_CodeList	Open enumeration or identifier of entry in a vocabulary	
Literal	S100_TruncatedDate	truncated format for date	

**2a-4.2.11 S100\_CD\_AttributeConstraints**

Role Name	Name	Description	Mult.	Data Type	Remarks
Class	S100_CD_AttributeConstraints	Constraints of a simple attribute	-	-	
Attribute	stringLength	Shall be represented as a positive integer (i.e., greater than zero) that specifies the maximum number of characters that may be assigned to the text attribute type. If not specified, then the text length shall be unconstrained.	0..1	PositiveInteger	
Attribute	textPattern	A character string that specifies a scheme of one or more constraints on the structure of the text values that may be assigned to the attribute. This shall be achieved by using a regular expression. W3C XML Standard Part 2 Appendix F (Regular Expressions) shall be used to define text patterns in this standard.	0..1	CharacterString	
Attribute	range	Specifies the range of allowed numeric values.	0..1	S100_NumericRange	
Attribute	precision	Specifies the precision of a real number.	0..1	NonNegativeInteger	

**2a-4.2.12 S100\_CD\_ComplexAttributeConcept**

Role Name	Name	Description	Mult	Data Type	Remarks
Class	S100_CD_ComplexAttributeC oncept	A complex attribute type in a feature concept dictionary	-	-	Derived from S100_CD_AttributeConcept
Association	subAttribute	References the sub attribute	1..*	S100_CD_AttributeConcept	Characteristics defined by S100_CD_AttributeUsage

**2a-4.2.13 S100\_CD\_AttributeUsage**

This class specifies the characteristics of the association between a complex attribute type and its sub attributes.

Role Name	Name	Description	Mult	Data Type	Remarks
Class	S100_CD_AttributeUsage	Characteristics of the association between a complex attribute and its sub attributes.	-	-	
Attribute	multiplicity	Number of occurrences of the sub attribute	1	S100_Multiplicity	
Attribute	sequential	Boolean value that indicates if the sub attributes of a complex attribute are in a particular order.	1	Boolean	It is only applicable if a sub attribute has multiplicity > 1.

**2a-4.2.14 S100\_CD\_EnumeratedValueConcept**

This class is derived from S100\_CD\_RegisterItem and describes the characteristics of an enumerated value type.

Role Name	Name	Description	Mult	Data Type	Remarks
Class	S100_CD_EnumeratedValueConcept	Characteristics of an enumerated value type in a feature concept dictionary	-	-	
Attribute	numericCode	A positive integer designating the unique value in the domain	1	PositiveInteger	
Association	associatedAttribute	specifies the attribute type item for which this is a domain value.	1	Boolean	

**2a-4.2.15 S100\_CD\_InformationConcept**

Role Name	Name	Description	Mult	Data Type	Remarks
Class	S100_CD_InformationConcept	Characteristics of an information type in a feature concept dictionary	-	-	
Attribute	alphaCodeIdentifier	abbreviation designating the information type item	0..1	S100_CD_AlphaCode	See below
Association	distinction	similar information types that this is distinct from	0..1	S100_CD_InformationConcept	

**2a-4.2.16 S100\_CD\_AlphaCode**

Role Name	Name	Description	Mult	Data Type	Remarks
Class	S100_CD_AlphaCode	Abbreviation designating the item	-	-	
Attribute	code	The code	6	Character	See below

The code must:

- 1) be unique within the registry for all registered items that have an alpha code characteristic;
- 2) be exactly six characters;
- 3) conform to ISO 646 with uppercase characters A-Z, 0-9, "\_", "\$"; and lowercase characters a-z;
- 4) begin with uppercase A-Z, lowercase a-z, or "\$."

Example "PUBREF" is the Alpha Code designating a feature type item named "Publication Reference."



**2a-4.2.17 S100\_RE\_ReferenceSource**

Each item in a feature concept dictionary has a definition. If the definition is taken from an external source, this class describes the reference(s) to the source document. Further details can be found in S-100 Part 2.

**2a-4.2.18 S100\_RE\_Reference**

This class defines the references to other documents where additional information regarding a registered item can be found. Further details can be found in S-100 Part 2.

**2a-4.2.19 S100\_RE\_ManagementInfo**

This class contains the management information of a register item. Further details can be found in S-100 Part 2.



## Appendix 2a - A

### Example of a complex attribute (informative)

A light may have several sectors. All of them share the same light characteristic and sequence. Other common attributes are the height and the name.

All attributes describing one sector in a complex attribute are structured “Light sector”.

A complex attribute for the “Rhythm of light” is also defined.

The simple attributes used in “lightSector” are:

- sectorLimit1 (type Real)
- sectorLimit2 (type Real)
- colour (type Enumeration)
- valueOfNominalRange (type Real)

Therefore the complex attribute is:

Characteristic	Value	
Name	Light sector	
Definition	A sector is the part of a circle between two straight lines drawn from the centre to the circumference. (Advanced Learner’s Dictionary, 2nd Edition).	
Remarks	n/a	
CamelCase	lightSector	
AlphaCode	LITSEC	
Sub Attributes	Attribute Binding	
CamelCode Identifier	multiplicity	sequential
sectorLimit1	1	n/a
sectorLimit2	1	n/a
colour	1	n/a
valueOfNominalRange	0..1	n/a

Note: The multiplicity and sequence are carried in the attribute between the complex and sub-attribute.

The “Rhythm of light” consists of:

- lightCharacteristic
- signalPeriod
- signalGroup

Characteristic	Value	
Name	Rhythm of light	
Definition		
Remarks	n/a	
CamelCase	rhythmOfLight	
AlphaCode	RHYLGT	
Sub Attributes	Attribute Binding	
CamelCode Identifier	multiplicity	sequential

lightCharacteristic	1	n/a
signalPeriod	0..1	n/a
signalGroup	0..1	n/a

A second way of describing the rhythm of light is the “signal sequence” as it is currently done with the SIGSEQ attribute. A signal sequence consists of intervals where the signal is either on or off (here light or eclipse)

Characteristic	Value	
Name	Signal sequence interval	
Definition	tbd.	
Remarks	n/a	
CamelCase	signalSequenceInterval	
AlphaCode	SGSQIN	
<b>Sub Attributes</b>	<b>Attribute Binding</b>	
<b>CamelCode Identifier</b>	<b>multiplicity</b>	<b>sequential</b>
signalStatus	1	n/a
duration	1	n/a

A Signal sequence is then just an ordered list of those intervals.

Characteristic	Value	
Name	Signal sequence	
Definition	The sequence of times occupied by intervals of light and eclipse for all “light characteristics”. (Adapted from S-57 Edition 3.1, Appendix A – Chapter 2, Page 2.191, November 2000).	
Remarks	n/a	
CamelCase	signalSequence	
AlphaCode	SIGSEQ	
<b>Sub Attribute</b>	<b>Attribute Binding</b>	
<b>CamelCode Identifier</b>	<b>multiplicity</b>	<b>sequential</b>
signalSequenceInterval	1..*	True

A light object would now consist of:

light:

- rhythmOfLight [1..\*]
- lightSector [1..\*]
- signalSequence [0..1]
- objectName[0..1]
- height[0..1]

This definition would be in the feature catalogue, although the definition of the attributes is in the data dictionary.

# **S-100 – Part 2b**

## **Portrayal Register**

## Contents

2b-1	Scope .....	3
2b-1.1	Conformance.....	3
2b-2	Normative references.....	3
2b-3	General concepts .....	4
2b-3.1	Register.....	4
2b-3.2	Portrayal Register .....	4
2b-3.3	Portrayal catalogue .....	4
2b-4	IHO Portrayal Register .....	4
2b-4.1	Types of registered items.....	4
2b-4.2	Data model of a Portrayal Register.....	5
2b-4.2.1	UML Model.....	5
2b-4.2.2	S100_PR_Register .....	6
2b-4.2.3	S100_PR_RegisterItem .....	6
2b-4.2.4	RE_ItemStatus.....	6
2b-4.2.5	S100_PR_ColorToken .....	6
2b-4.2.6	S100_PR_ColorProfile .....	6
2b-4.2.7	S100_PR_VisualItem .....	7
2b-4.2.8	S100_PR_Font.....	7
2b-4.2.9	S100_PR_DisplayPlane.....	8
2b-4.2.10	S100_PR_ContextParameter .....	8

## **2b-1 Scope**

The IHO registry will contain a number of registers, one of which will be for portrayal. A portrayal register specifies the portrayal of data. The portrayal of data is independent of the data but closely related to the data. That is the attributes within the data set drive the portrayal process, but there may be many different portrayals for the same data. The use of a register to store aspects of portrayal will significantly improve the IHO's ability to manage and extend multiple products based on S-100 which can be made available for use in a relatively short timescale. This register will support wider use of registered items by making them publicly available and increase their visibility to potential users. This Part describes the content of the portrayal register.

### **2b-1.1 Conformance**

This profile conforms to conformance class 2 of ISO 19106:2004.

## **2b-2 Normative references**

The following referenced documents are required for the application of this document. For dated references, only the edition cited applies. For undated references, the latest edition of the referenced document (including amendments) applies.

ISO 19135:2005, Geographic Information – Procedures for registration of items of geographic information

ISO/DIS 19126:2008, Geographic Information – Feature concept dictionaries and registers

ISO 19117:2012. Geographic Information – Portrayal

## **2b-3 General concepts**

### **2b-3.1 Register**

As described in Part 2, a register is simply a managed list. It is easier to maintain than a fixed document, because new items can be added as needed to the register, and existing items in the register can be clarified, superseded or retired. Each register item has one or more dates associated with it that indicate when changes in its status occurred. This means that a product specification, defined at a given date, may reference an item in the register at that specific point in time.

### **2b-3.2 Portrayal Register**

A portrayal register specifies independent sets of definitions of point symbols, pattern symbols, complex line styles, and colour symbols. In addition, the portrayal register may be subdivided into different domains. The portrayal register may be used to develop the portrayal catalogue. Unlike the portrayal catalogue, a portrayal register does not define the portrayal rules or bind the portrayal to a feature.

Registers of portrayal information may serve as sources of reference for similar registers established by other geographic information communities as part of a system of cross-referencing.

### **2b-3.3 Portrayal catalogue**

The Portrayal Catalogue contains portrayal functions that map the features to symbology it also contains symbol definitions, colour definitions, portrayal parameters and portrayal management concepts such as viewing groups. Portrayal Catalogues are described in detail in S-100 Part 9.

## **2b-4 IHO Portrayal Register**

### **2b-4.1 Types of registered items**

The following are types of items that may be registered.

- 1) Pixmap
- 2) Color Token
- 3) Color Profile
- 4) Symbol
- 5) Line Style
- 6) Area Fill
- 7) Font
- 8) Viewing Group
- 9) Viewing Group Layer
- 10) Display Mode
- 11) Display Plane
- 12) Context Parameter



- 13) Symbol Schema
- 14) Line Style Schema
- 15) Area Fill Schema
- 16) Pixmap Schema
- 17) Color Profile Schema
- 18) Cascading Style Sheet
- 19) Display priority

## 2b-4.2 Data model of a Portrayal Register

### 2b-4.2.1 UML Model

The following figure shows the information model of the hydrographic portrayal register:

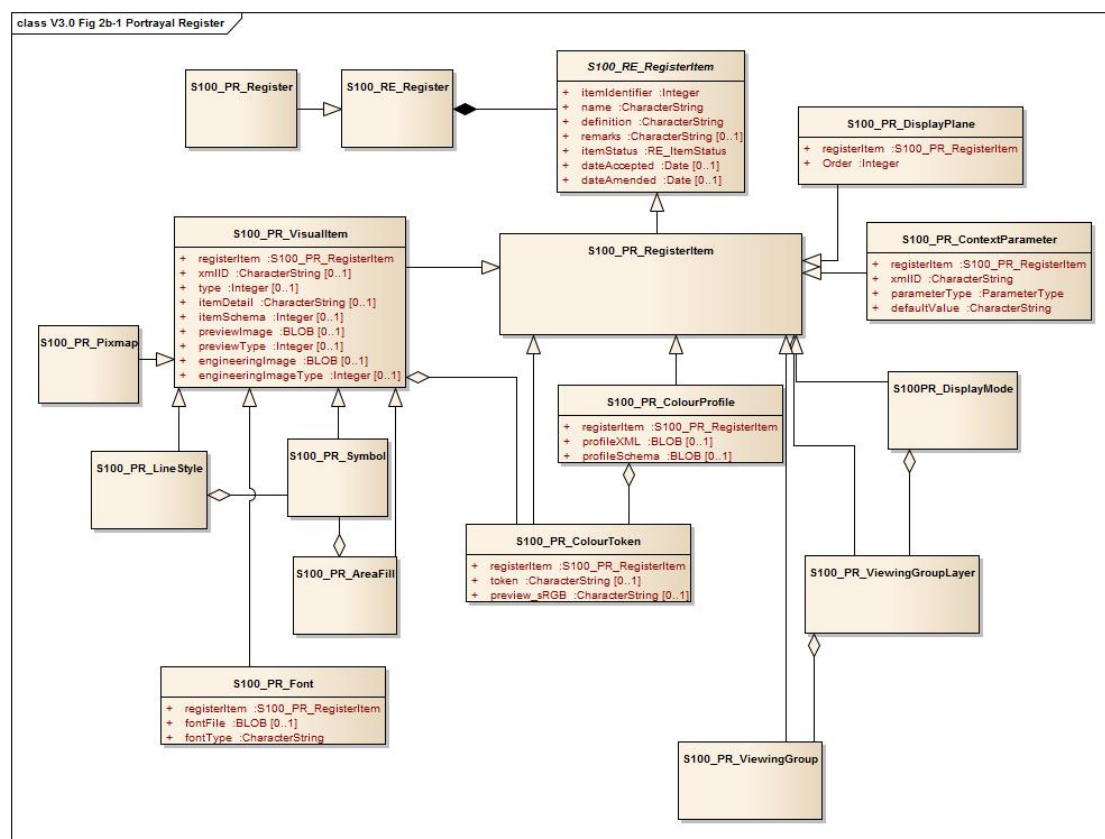


Figure 2b-1 – Portrayal Register

### 2b-4.2.2 S100\_PR\_Register

This class S100\_PR\_Register is derived from S100\_RE\_Register. It is extended with an 'owner' and 'domain'. The intention is that each domain or organization may have a dedicated register.

### 2b-4.2.3 S100\_PR\_RegisterItem

The class S100\_PR\_RegisterItem is a specialization of the class S100\_RE\_RegisterItem and carries the characteristics that are common to all types of registered items listed in clause 2a-4.1

### 2b-4.2.4 RE\_ItemStatus

The class RE\_ItemStatus identifies the registration status of the S100\_PR\_RegisterItem. Further details can be found in S-100 Part 2.

### 2b-4.2.5 S100\_PR\_ColorToken

This class is derived from S100\_PR\_RegisterItem. The definition of a color token as a register item of type 'colorToken' and carries the token string and a preview RGB value in Hex encoding. Specific color CIE values etc are stored in a color profile structure.

Role Name	Name	Description	Mult	Data Type	Remarks
Class	S100_PR_ColorToken	Definition of a color token	-	-	
Attribute	registerItem		1	S100_PR_RegisterItem	
Attribute	token		0..1	CharacterString	
Attribute	Preview_sRGB		0..1	CharacterString	

### 2b-4.2.6 S100\_PR\_ColorProfile

. This class is derived from S100\_PR\_RegisterItem.

Role Name	Name	Description	Mult	Data Type	Remarks
Class	S100_PR_ColorProfile	The specific content for a colour profile as a register item of type 'colorProfile'	-	-	

Attribute	registerItem		1	S100_PR_RegisterItem	
Attribute	profileXML	XML file for the color profile	0..1		
Attribute	profileSchema	Schema for the XML file of the color profile	0..1		

#### 2b-4.2.7 S100\_PR\_VisualItem

The specific content for a register item of type 'symbol', 'lineStyle', 'areaFill' or 'pixmap' defined in PR\_VisualType. The visual items each have an XML identifier string and XML document defining the item details as well as a preview image and an engineering Image with dimensions.

Role Name	Name	Description	Mult	Data Type	Remarks
Class	S100_CD_FeatureConcept	A feature type in a feature concept dictionary	-	-	
Attribute	registerItem		1	S100_PR_RegisterItem	
Attribute	xmlID		0..1		
Attribute	type		0..1	Integer	symbol, lineStyle, areaFill, or pixmap
Attribute	itemDetail		0..1	CharacterString	
Attribute	itemSchema		0..1	Integer	
Attribute	previewImage		0..1	Blob	
Attribute	previewType		0..1	Integer	
Attribute	engineeringImage		0..1	Blob	
Attribute	engineeringImageType		0..1	Integer	

#### 2b-4.2.8 S100\_PR\_Font

This is a specialization of S100\_PR\_VisualItem.

Role Name	Name	Description	Mult	Data Type	Remarks
Class	S100_PR_Font	The specific content for a font file definition as a register item of type 'font'.	-	-	
Attribute	registerItem		1	S100_PR_RegisterItem	

Attribute	fontFile		0..1	Blob	
Association role	fontType		0..1	CharacterString	

#### 2b-4.2.9 S100\_PR\_DisplayPlane

S100\_PR\_DisplayPlane is a specialization of S100\_PR\_RegisterItem.

Role Name	Name	Description	Mult.	Data Type	Remarks
Class	S100_PR_DisplayPlane	The specific content for a display plane definition as a register item of type 'displayPlane'.	-	-	
Attribute	registerItem		1	S100_PR_RegisterItem	
Attribute	Order		1	Integer	

#### 2b-4.2.10 S100\_PR\_ContextParameter

S100\_PR\_ContextParameter is a specialization of S100\_PR\_RegisterItem.

Role Name	Name	Description	Mult.	Data Type	Remarks
Class	S100_PR_ContextParameter	The specific content for a context parameter as a register item of type 'contextParameter'.	-	-	
Attribute	registerItem		1	S100_PR_RegisterItem	
Attribute	xmlID		1	CharacterString	
Attribute	parameterType		1	ParameterType	
Attribute	defaultValue		1	CharacterString	

# **S-100 Part 3**

## **General Feature Model and Rules for Application Schema**

## Contents

3-1	Scope .....	1
3-2	Conformance .....	1
3-3	References .....	2
3-4	Context .....	3
3-4.1	Objects .....	3
3-4.2	Derivation of the General Feature Model .....	3
3-5	Principles for defining features and information types .....	3
3-5.1	Identifiable objects.....	3
3-5.1.1	Features .....	3
3-5.1.2	Information types.....	3
3-5.2	The General Feature Model .....	3
3-5.2.1	Introduction.....	3
3-5.2.2	The purpose of the GFM .....	4
3-5.2.3	The main structure of the GFM .....	4
3-5.2.4	S100_GF_NamedType .....	4
3-5.2.5	S100_GF_ObjectType.....	5
3-5.2.6	S100_GF_FeatureType.....	5
3-5.2.7	S100_GF_PropertyType .....	6
3-5.2.8	S100_GF_AttributeType.....	6
3-5.2.9	S100_GF_AssociationRole .....	7
3-5.2.10	GF_Operation.....	7
3-5.2.11	S100_GF_AssociationType.....	7
3-5.2.12	S100_GF_InformationType .....	7
3-5.2.13	S100_GF_FeatureAssociationType .....	8
3-5.2.14	S100_GF_InformationAssociationType .....	8
3-5.2.15	S100_GF_Constraint.....	9
3-5.3	Attributes of feature types .....	10
3-5.3.1	Introduction.....	10
3-5.3.2	S100_GF_ThematicAttributeType.....	10
3-5.3.3	S100_GF_ComplexAttributeType .....	11
3-5.3.4	S100_GF_SimpleAttributeType .....	11
3-5.3.5	S100_GF_SpatialAttributeType .....	11
3-5.3.6	GF_TemporalAttributeType.....	11
3-5.3.7	GF_MetadataAttributeType.....	11
3-5.3.8	GF_QualityAttributeType.....	11
3-5.3.9	GF_LocationAttributeType .....	11
3-5.3.10	S100_TruncatedDateAttributeType.....	12
3-5.3.11	S100_GF_CodelistAttributeType .....	12
3-5.3.12	S100_GF_EnumerationType.....	12
3-5.4	Relationships between named types .....	12
3-5.4.1	Introduction.....	12
3-5.4.2	GF_InheritanceRelation .....	12
3-5.4.3	S100_GF_AssociationType.....	13
3-5.4.4	Associations to information types.....	13
3-5.4.5	Default names for association ends.....	13
3-5.5	Behaviour of feature types .....	14
3-5.6	Constraints .....	14
3-6	Rules for application schema (ISO 19109 Clause 8) .....	14
3-6.1	The application modelling process (ISO 19109 Clause 8.1).....	14
3-6.2	The application schema (ISO 19109 Clause 8.2) .....	14
3-6.2.1	Conceptual schema language for application schemas.....	14
3-6.2.2	Main rules.....	14
3-6.2.3	Identification of application schemas .....	14
3-6.2.4	Documentation of an application schema .....	15
3-6.3	Rules for application schema in UML (ISO 19109 Clause 8.3).....	15
3-6.3.1	Main rules (ISO 19109 Clause 8.3.1).....	15
3-6.4	Domain profiles of standard schemas in UML (ISO 19109 Clause 8.4) .....	16
3-6.4.1	Rules for adding information to a standard schema .....	16

3-6.4.2	Restricted use of standard schemas.....	16
3-6.4.3	Rules for use of metadata schema (ISO 19109 Clause 8.5) .....	16
3-6.4.4	Temporal rules (ISO 19109 Clause 8.6) .....	16
3-6.5	Spatial rules (ISO 19109 Clause 8.7).....	16
3-6.5.1	General spatial rules (ISO 19109 Clause 8.7.1) .....	16
3-6.5.2	Spatial attributes.....	16
3-6.5.3	Spatial Quality .....	17
3-6.5.4	Geometric aggregates and complexes to represent spatial attributes of features.....	17
3-6.6	Cataloguing rules (ISO 19109 Clause 8.8) .....	17
3-6.6.1	Introduction (ISO 19109 Clause 8.8.1).....	17
3-6.6.2	Application schema based on a feature catalogue (ISO 19109 Clause 8.8.2) .....	18
3-6.6.3	Character encoding .....	18
3-6.7	Codelists.....	18
3-7	Application Schema for Coverages.....	19
3-7.1	Introduction.....	19
3-7.2	Gridded Data .....	19
3-7.3	Variable Cell Size Grid .....	20
3-7.4	Feature Oriented Image .....	21
3-8	Interpretation of models of time intervals and period .....	22
3-9	Use of format-specific types for truncated dates.....	23

### 3-1 Scope

This Part introduces a General Feature Model (GFM) which is a conceptual model of features, their characteristics and associations. It also describes the rules for developing an application schema which is a basic part of any S-100 based product specification.

The scope of this Part includes:

- 1) Conceptual modelling of features and their properties from a reality;
- 2) Conceptual modelling of information types and their attributes;
- 3) Definition of application schema;
- 4) Rules for application schema;

The following is outside scope:

- 1) Representation of feature types and their properties and information types and their properties in a catalogue;
- 2) Representation of metadata;
- 3) Rules for mapping one application schema to another;
- 4) Implementation of the application schema in a computer environment;
- 5) Computer system and application schema software design;
- 6) Programming.

Computer systems, software design and programming are not addressed in this document.

### 3-2 Conformance

This profile conforms to conformance class 2 of ISO 19106:2004. The following is a brief description of the specializations and generalizations where the S-100 General Feature Model differs from ISO 19109.

- 1) A new S100\_GF\_NamedType is introduced.
- 2) A new S100\_GF\_ObjectType is introduced as a specialisation of S100\_GF\_NamedType.
- 3) A new S100\_GF\_InformationType is introduced as a specialisation of S100\_GF\_ObjectType, it is constrained to associations with S100\_GF\_ThematicAttributeType.
- 4) S100\_GF\_FeatureType is a specialization of S100\_GF\_ObjectType,
- 5) S100\_GF\_AttributeType is a specialization of GF\_AttributeType in that it is abstract in S-100.
- 6) A new abstract S100\_GF\_SimpleAttributeType is introduced as a specialisation of S100\_GF\_ThematicAttributeType.
- 7) GF\_Operation is not used.
- 8) GF\_InheritanceRelation is not used; feature inheritance is represented by the association inheritance.
- 9) The association attributeOfAttribute is not used. The concept of the complex attribute is used in S-100 to perform a similar function.
- 10) S100\_GF\_AssociationType does not use the generalization association between GF\_AssociationType and GF\_FeatureType. Instead it is a specialisation of S100\_GF\_NamedType.
- 11) S100\_GF\_AssociationType is associated with S100\_GF\_ThematicAttributeType by a UML aggregation relationship. This means associations can have descriptive characteristics.
- 12) New metaclasses S100\_GF\_FeatureAssociationType and S100\_GF\_InformationAssociationType are introduced as specialisations of S100\_GF\_AssociationType.
- 13) The association role linkBetween of the GF\_FeatureType/GF\_AssociationType relationship in ISO 19109 is realized as follows:



- a) role linkBetween of the S100\_FeatureType/S100\_GF\_FeatureAssociationType relationship
- b) role linkBetween of the S100\_InformationType / S100\_GF\_InformationAssociationType relationship
- c) role informationLink of the S100\_ObjectType / S100\_InformationAssociationType relationship.

This means that associations that include only feature types have semantics and multiplicity constraints that are different from associations that include at least one information type.

- 14) GF\_LocationAttributeType, GF\_TemporalAttributeType, GF\_MetaDataAttributeType and GF\_QualityAttributeType are not used.

Further reference or explanation of the above changes can be found in the following text where appropriate.

### 3-3 References

ISO 8601:2004: Data elements and interchange formats – Information interchange – Representation of dates and times.

ISO 19106:2003 Geographic information - Geographic Information - Profiles

ISO 19108:2002 Geographical Information – Temporal Schema (as corrected by Technical Corrigendum 1 – 2006)

ISO 19107:2003 Geographic information - Spatial schema

ISO 19109:2005 Geographic information - Rules for application schema

ISO 19110:2005 Geographic information - Methodology for feature cataloguing

ISO 19115:2005 Geographic information - Metadata

ISO/CD 19115-2 Geographic information - Metadata - part 2 – Extensions for imagery and gridded data

## **3-4 Context**

### **3-4.1 Objects**

The data content of a geographic application is defined in accordance with a view of real world features and in the context of the requirements of a particular application. The content is structured in terms of objects. This document considers two types of object:

- 1) Features – features are defined together with their properties
- 2) Information Types – information types are used to share information among features and other information types. Information types have only thematic attribute properties.

The GFM provides a conceptual model for these objects. The definitions for object types are held in a feature catalogue. The GFM also acts as a conceptual model for the feature catalogue.

### **3-4.2 Derivation of the General Feature Model**

A conceptual model of types that shall be used in S-100 products is presented in this document. It is known as the GFM and is derived from the ISO 19109 General Feature Model by realization of its classes (Figure 3-1).

## **3-5 Principles for defining features and information types**

### **3-5.1 Identifiable objects**

#### **3-5.1.1 Features**

A feature is an abstract representation of real world phenomenon. Features have two aspects – feature type and feature instance. A feature type is class and is defined in a feature catalogue. A feature instance is a single occurrence of the feature type and represented as an object in a data set.

#### **3-5.1.2 Information types**

An information type is a class of object which is defined in a feature catalogue. An instance of an information type is an identifiable unit of information in a data set. Information types have only thematic attribute properties. An instance of an information type may be associated with one or more feature instances or other instances of information type.

EXAMPLE A chart note may be modelled as an information type

### **3-5.2 The General Feature Model**

#### **3-5.2.1 Introduction**

This sub-clause identifies and describes the concepts used to define features and information types and their relationships. These concepts are expressed in a conceptual model called the GFM.

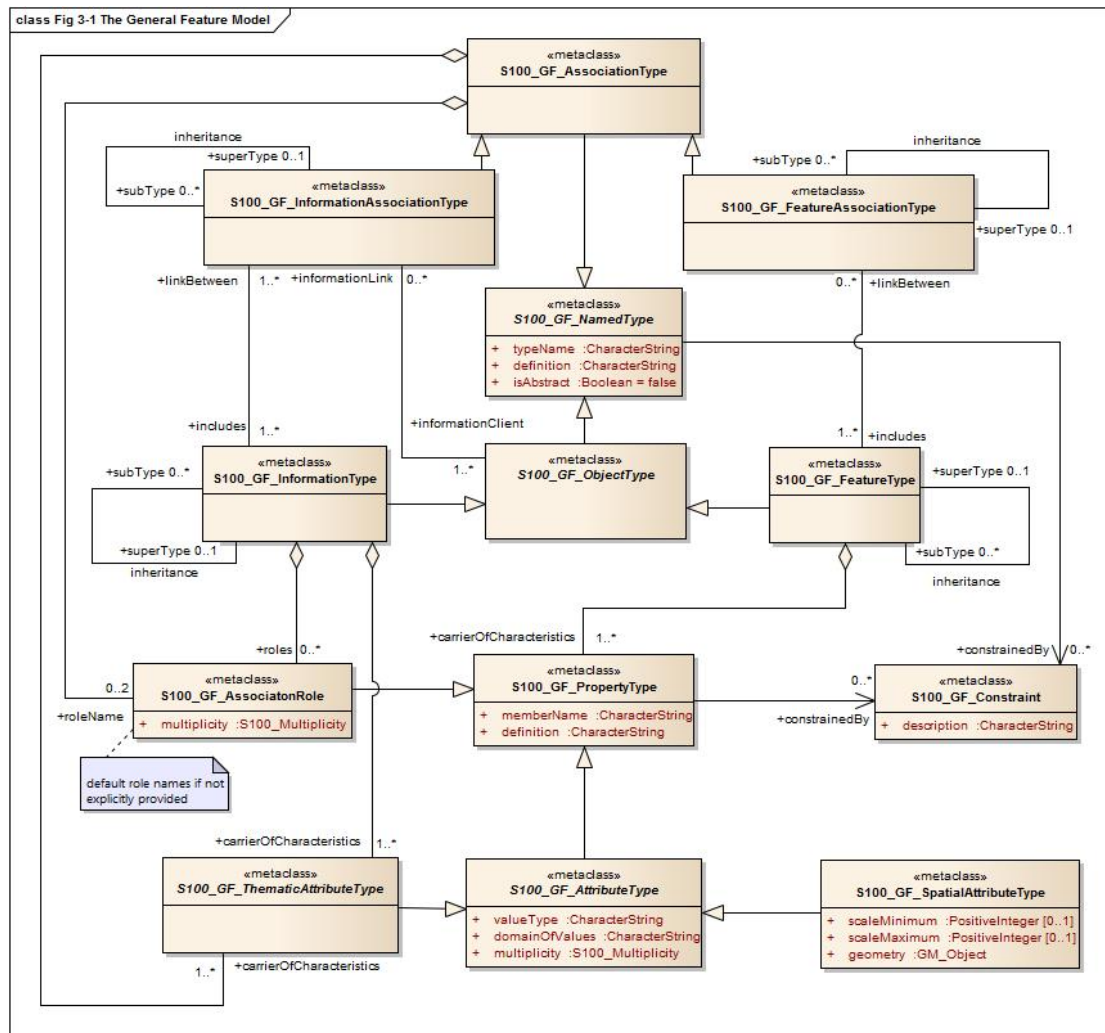


Figure 3-1 — The General Feature Model

### 3-5.2.2 The purpose of the GFM

The GFM is a basis for the classification of features and information types and their properties. The GFM also acts as the basis for the structure of feature catalogues.

### 3-5.2.3 The main structure of the GFM

Figure 3-1 shows a UML model of the S-100 GFM.

The following clauses define the elements of the GFM.

#### 3-5.2.4 S100\_GF\_NamedType

The class S100\_GF\_NamedType is not realised from ISO 19109 but is introduced specifically for the S-100 GFM. It is an abstract super-class of the classes S100\_GF\_ObjectType and S100\_GF\_AssociationType. The intention in introducing this class is to show the commonality between object types and association types within S-100. Both types are core identifiable objects of S-100 data schemas.

**Table 3-1— S100\_GF\_NamedType**

Role Name	Name	Description	Mult.	Type
Class	S100_GF_NamedType	Abstract base class for object types and association types within the GFM.	-	-
Attribute	typeName	Name of the named type. The name shall be unique within a namespace.	1	CharacterString
Attribute	definition	Definition that describes the named type.	1	CharacterString
Attribute	isAbstract	If true, the named type acts as an abstract supertype. It is not possible to create an instance of an abstract type	1	Boolean
Role	constrainedBy	The role specifies that a constraint is made on the named type.	0..*	S100_GF_Constraint

### 3-5.2.5 S100\_GF\_ObjectType

The class S100\_GF\_ObjectType is not realised from ISO 19109 but is introduced specifically for the S-100 GFM. It is an abstract super-class of the classes S100\_GF\_FeatureType and S100\_GF\_InformationType. The intention in introducing this class is to show the commonality between feature types and information types in particular the ability of these classes to be linked to information types by means of a information association.

**Table 3-2— S100\_GF\_ObjectType**

Role Name	Name	Description	Mult.	Type
Class	S100_GF_ObjectType	Abstract base class for object types within the GFM.	-	-
Role	informationLink	Link to an information association that describes the relationship to an instance of an information type.	0..*	S100_GF_Information AssociationType

### 3-5.2.6 S100\_GF\_FeatureType

The class S100\_GF\_FeatureType is a realisation of the ISO 19109 class GF\_FeatureType. It differs from the ISO class in the following ways:

- It is a sub-type of the class S100\_GF\_NamedType;
- It does not realise the Generalization and Specialization associations with the class GF\_InheritanceRelation. Instead, the class has an association with itself with the roles subType and superType. GF\_InheritanceRelation is not realised in the S-100 GFM;
- The multiplicity of the superType is 0..1 to represent the concept that a feature may have a maximum of one superType. This is in order to prevent multiple-inheritance in S-100;
- The multiplicity of the role carrierOfCharacteristics with S100\_GF\_PropertyType (the S-100 realisation of GF\_PropertyType) is changed from 0..\* to 1..\*. An S-100 feature must have properties.

**Table 3-3— S100\_GF\_FeatureType**

Role Name	Name	Description	Mult.	Type
Class	S100_GF_FeatureType	A type for an abstract representation of a real world phenomenon.	-	-
Role	superType	The more generic feature type from which this feature type is derived.	0..1	S100_GF_FeatureType
Role	subType	The more specific feature types which are derived from this feature type.	0..*	S100_GF_FeatureType
Role	linkBetween	A link to a feature association that specify the relationship between one feature type and the same or another feature type.	0..*	S100_GF_FeatureAssociationType
Role	carrierOfCharacteristics	Attributes and roles that describe the characteristics of a feature type.	1..*	S100_GF_PropertyType

### 3-5.2.7 S100\_GF\_PropertyType

The class S100\_GF\_PropertyType is a realisation of the ISO 19109 class GF\_PropertyType. It differs from the ISO class in the following ways:

- 1) The multiplicity of the association with S100\_GF\_FeatureType is changed from 1 to 1..\*. This change represents the way that features and properties are described in the S-100 Feature Catalogue. Property type definitions can be used in one or more feature type definitions;
- 2) The association type of the association with S100\_GF\_FeatureType is changed from composition to aggregation as a result of the change in multiplicity described above.

**Table 3-4 — S100\_GF\_PropertyType**

Role Name	Name	Description	Mult.	Type
Class	S100_GF_PropertyType	Abstract base class for all properties of a feature type. These are attributes and roles.	-	-
Attribute	memberName	Name of the attribute or role.	1	CharacterString
Attribute	definition	Description of the attribute or role of the feature type.	1	CharacterString
Role	constrainedBy	The role specifies that a constraint is made on the property	0..*	S100_GF_Constraint

### 3-5.2.8 S100\_GF\_AttributeType

The class S100\_GF\_AttributeType is the S-100 realisation of GF\_AttributeType. It is largely identical to the ISO 19109 class but differs in the following way:

- 1) The association attributeOfAttribute is not realised in the S-100 GFM. S-100 introduces, instead, the concept of complex attributes. Complex attributes are described further in ISO 19109 subclause 7.4.

**Table 3-5— S100\_GF\_AttributeType**

Role Name	Name	Description	Mult.	Type
Class	S100_GF_AttributeType	Abstract base class for all attributes of feature types. In this model are two sub classes: thematic attributes and spatial attributes.	-	-
Attribute	valueType	The data type of the attribute value.	1	CharacterString
Attribute	domainOfValues	Description of a set of values. For codelist types this may be a URI identifying a dictionary or "vocabulary."	1	CharacterString
Attribute	multiplicity	The number of instances of the attribute that may be associated with a single instance of a feature type	1	S100_Multiplicity

### 3-5.2.9 S100\_GF\_AssociationRole

The class S100\_GF\_AssociationRole is the S-100 realisation of the ISO 19109 class GF\_AssociationRole.

**Table 3-6 — S100\_GF\_AssociationRole**

Role Name	Name	Description	Mult.	Type
Class	S100_GF_AssociationRole	A role used in an association	-	-
Attribute	multiplicity	The number of objects that may be associated within the association.	1	S100_Multiplicity

### 3-5.2.10 GF\_Operation

The class GF\_Operation is not realised in the S-100 GFM because S-100 supports only the data transfer model. Datasets cannot contain operations.

### 3-5.2.11 S100\_GF\_AssociationType

The class S100\_GF\_AssociationType is the S-100 realisation of the ISO 19109 class GF\_AssociationType. It differs from the ISO 19109 class in the following way:

- 1) The ISO 19109 GFM models GF\_AssociationType as a subtype of the class GF\_FeatureType. This is done for reasons which are set out in Note 1 of ISO 19109 clause 7.3.9. The S-100 model does not model the class as a subtype of S100\_GF\_FeatureType. Within S-100 associations between feature types are not considered abstractions of real world phenomena. The result of this approach to modelling the GFM is that the only properties associations can have are thematic attributes.
- 2) The multiplicity of roleName is 0..2 instead of 1..\*. The lower bound of 0 means the role is one of the default roles “source” or “target” and this is obvious from the application schema’s semantics of the association type’s name and the names of the participating feature or information classes. The upper bound expresses the constraint that S100 does not allow associations with more than two participating classes.

**Table 3-7— S100\_GF\_AssociationType**

Role Name	Name	Description	Mult.	Type
Class	S100_GF_AssociationType	Abstract base class for feature associations and information associations	-	-
Role	carrierOfCharacteristics	The thematic attributes that describes the association.	0..*	S100_GF_ThematicAttributeType
Role	roleName	The roles that describes the ends of the association	0..2	S100_GF_AssociationRole

### 3-5.2.12 S100\_GF\_InformationType

S100\_GF\_InformationType is the class for information types within S-100. An information type is an identifiable object that can be associated with features in order to carry information particular to the associated features. An example of an information type might be a Chart Note. Information types can also be associated with each other. This could be done where there is further supplementary information that is relevant to the information type or where there is a need to translate the information. For example a primary information object carrying a Chart Note may contain text in English and an associated supplementary information object may carry the same text in German.

The characteristics of information types shall be carried by thematic attribute types only.

Therefore, S100\_GF\_InformationType is associated with only

S100\_GF\_ThematicAttributeType rather than the more generic class

S100\_GF\_PropertyType. The associations to information types are modelled by means of the type S100\_InformationAssociationType.

**Table 3-8 — S100\_GF\_InformationType**

Role Name	Name	Description	Mult.	Type
Class	S100_GF_InformationType	A type for an identifiable object carrying supplementary information for other objects.	-	-
Role	superType	The more generic information type from which this information type is derived.	0..1	S100_GF_InformationType
Role	subType	The more specific information types which are derived from this information type.	0..*	S100_GF_InformationType
Role	linkBetween	A link to an information association that specifies the relationship between one object type and this information type.	0..*	S100_GF_InformationAssociationType
Role	carrierOfCharacteristics	Thematic attributes that describe the characteristics of an information type.	1..*	S100_GF_ThematicAttributeType
Role	roles	Roles for associations to other information type that supplying supplementary information.	0..*	S100_GF_AssociationRole

**3-5.2.13 S100\_GF\_FeatureAssociationType**

The class S100\_GF\_FeatureAssociationType is not realised from ISO 19109 but is introduced specifically for the S-100 GFM. The reason for this is that in S-100 two types of associations are distinguished: feature associations and information associations. They are both semantically different and different in the model. This class describes the feature association. A feature association is the description of the relationship between two instances of feature types. It can be characterized by thematic attributes and has normally two roles. The roles describe the ends of the relationship since such relationship is usually not symmetric.

**Table 3-9— S100\_GF\_FeatureAssociationType**

Role Name	Name	Description	Mult.	Type
Class	S100_GF_FeatureAssociationType	A class for the description of a relationship between two feature types.	-	-
Role	superType	The more generic feature association from which this feature association is derived.	0..1	S100_GF_FeatureAssociationType
Role	subType	The more specific feature associations which are derived from this feature association.	0..*	S100_GF_FeatureAssociationType
Role	includes	The feature types which are included in this relationship.	1..*	S100_GF_FeatureType

**3-5.2.14 S100\_GF\_InformationAssociationType**

The class S100\_GF\_InformationAssociationType is not realised from ISO 19109 but is introduced specifically for the S-100 GFM. The reason for this is that in S-100 two types of associations are distinguished: feature associations and information associations. They are both semantically different and different in the model. This class describes the information association. An information association is the description of the relationship between an arbitrary object and an information type that supplies additional information for that object. The relationship can be characterized by thematic attributes and a role.

**Table 3-10— S100\_GF\_InformationAssociationType**

<b>Role Name</b>	<b>Name</b>	<b>Description</b>	<b>Mult.</b>	<b>Type</b>
Class	S100_GF_InformationAssociationType	A class for the description of a relationship between an object and an information type.	-	-
Role	superType	The more generic information association from which this information association is derived.	0..1	S100_GF_InformationAssociationType
Role	subType	The more specific feature associations which are derived from this feature association.	0..*	S100_GF_InformationAssociationType
Role	includes	The information type that is included in the relationship.	1..*	S100_GF_InformationType
Role	informationClient	The object types that act as client in the information association	1..*	S100_GF_ObjectType

**3-5.2.15 S100\_GF\_Constraint**

The class S100\_GF\_Constraint is a realisation of the ISO 19109 class GF\_Constraint with an association to S100\_GF\_NamedType instead of the ISO 19109 association to GF\_Feature\_Type.

**Table 3-11— S100\_GF\_Constraint**

<b>Role Name</b>	<b>Name</b>	<b>Description</b>	<b>Mult.</b>	<b>Type</b>
Class	S100_GF_Constraint	Class for constraints that may be associated with named types or their properties.	-	-
Attribute	description	The constraint described in natural language and/or in formal notation.	1	CharacterString



### 3-5.3 Attributes of feature types

#### 3-5.3.1 Introduction

This clause describes in more detail the role of attributes of features and information types.

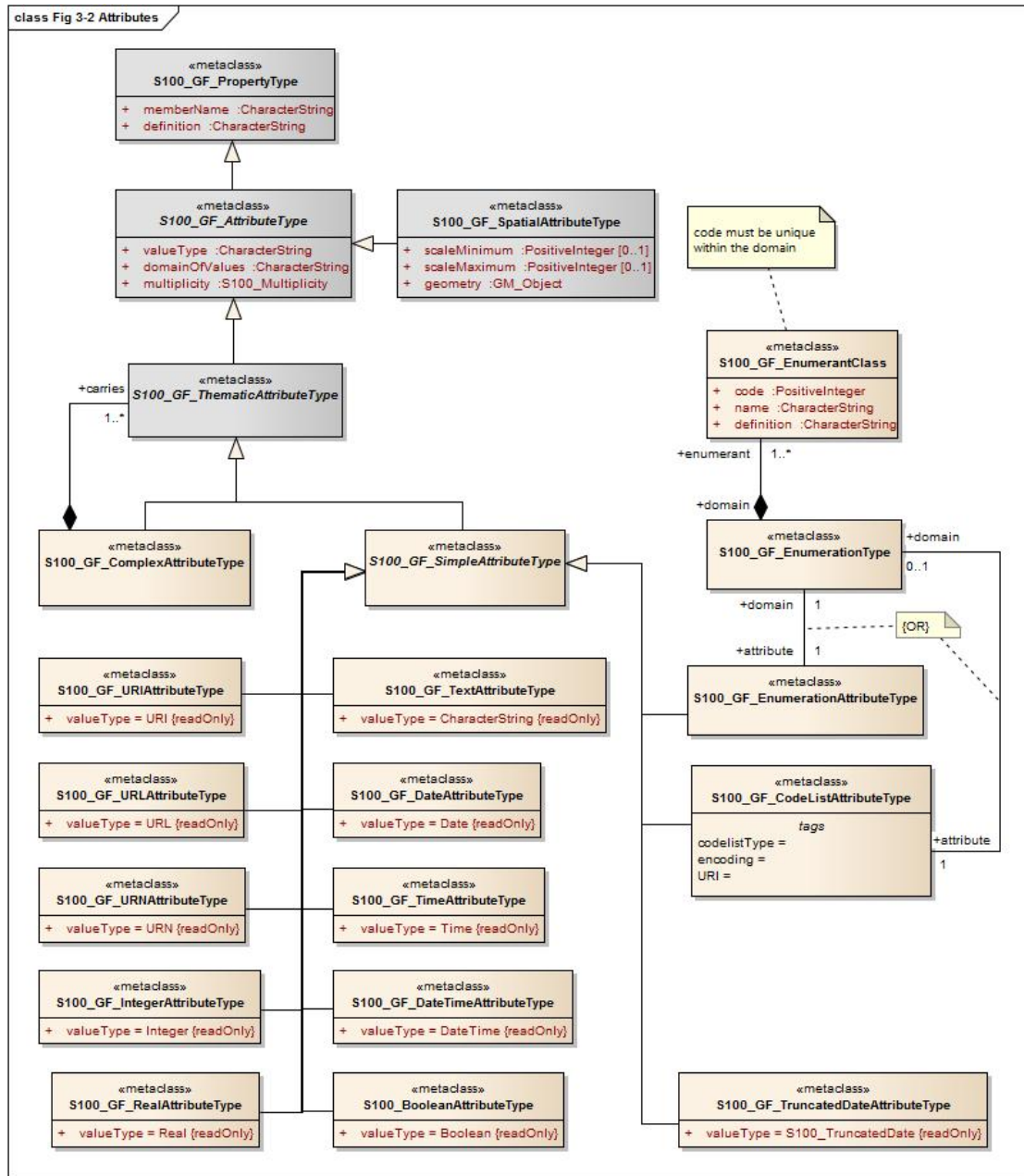


Figure 3-2 — Attributes

#### 3-5.3.2 S100\_GF\_ThematicAttributeType

The class `S100_GF_ThematicAttributeType` is a realisation of the ISO 19109 class `GF_ThematicAttributeType`. Thematic attribute types carry descriptive characteristics of objects other than those specified in ISO 19109 clauses 7.4.3 – 7.4.7. This class differs from the ISO 19109 class in the following ways:

- 1) `GF_ThematicAttributeType` is defined in ISO 19109 as a concrete class. The S-100 GFM realisation is an abstract class with two concrete subclasses – `S100_GF_SimpleAttributeType` and `S100_GF_ComplexAttributeType`.

- 2) Temporal information shall have their value type defined by the types Date, Time, DateTime, S100\_TruncatedDate or complex structures using combinations of the primitive temporal types.

**Table 3-12— S100\_GF\_ThematicAttributeType**

Role Name	Name	Description	Mult.	Type
Class	S100_GF_ThematicAttributeType	Abstract base class for all attributes other than spatial attributes.	-	-

### 3-5.3.3 S100\_GF\_ComplexAttributeType

The class S100\_GF\_ComplexAttributeType is introduced in the S-100 GFM. Complex attributes are a composition of other attributes either simple or complex.

### 3-5.3.4 S100\_GF\_SimpleAttributeType

The class S100\_GF\_SimpleAttributeType is introduced in the S-100 GFM. A simple attribute type carries a descriptive characteristic of a named type.

### 3-5.3.5 S100\_GF\_SpatialAttributeType

The class S100\_GF\_SpatialAttributeType is a realisation of the ISO 19109 class GF\_SpatialAttributeType. A spatial attribute type shall have a GM\_Object as its value type. GM\_Object and its sub-types are defined in the Spatial Schema, S-100 Part 7.

**Table 3-13— S100\_GF\_SpatialAttributeType**

Role Name	Name	Description	Mult.	Type
Class	S100_GF_SpatialAttributeType	Class representing a spatial attribute, which shall be used to express spatial characteristics of a feature type.	-	-
Attribute	scaleMinimum	The smallest denominator of a scale for that an instance of a feature type shall be used (e.g. for portrayal)	0..1	PositiveInteger
Attribute	scaleMaximum	The largest denominator of a scale for that an instance of a feature type shall be used (e.g. for portrayal)	0..1	PositiveInteger
Attribute	geometry	The object that describes the geometry of an instance of a feature type.	1	GM_Object

### 3-5.3.6 GF\_TemporalAttributeType

The ISO 19109 class GF\_TemporalAttributeType is not realised explicitly in the S-100 GFM. Temporal information shall be modelled using the thematic attribute type S100\_GF\_ThematicAttributeType (see section 6.3.3 for more details).

### 3-5.3.7 GF\_MetadataAttributeType

The ISO 19109 class GF\_MetadataAttributeType is not realised explicitly in the S-100 GFM. Metadata types shall be modelled using complex thematic attributes which realise types from the S-100 Part 4a metadata component. The complex thematic attributes shall be defined in a feature catalogue.

### 3-5.3.8 GF\_QualityAttributeType

The ISO 19109 class GF\_QualityAttributeType is not realised explicitly in the S-100 GFM. Quality metadata types shall be modelled using complex thematic attributes which realise types from the S-100 Part 4c Appendix 4c-A Data Quality. The complex thematic attributes shall be defined in a feature catalogue.

### 3-5.3.9 GF\_LocationAttributeType

The ISO 19109 class GF\_LocationAttributeType is not realised in the S-100 GFM.

### 3-5.3.10 S100\_TruncatedDateAttributeType

The class S100\_TruncatedDateAttributeType is intended for modelling date values with one or more of the more significant components omitted. This allows partial dates to be used, e.g., for recurring periods.

### 3-5.3.11 S100\_GF\_CodelistAttributeType

The class S100\_GF\_CodelistAttributeType is introduced in the S-100 GFM for modelling S-100 codelists. Codelist attributes must be associated to either an enumeration (for open enumeration codelists) or a dictionary (for open and closed dictionary codelists) but not both. The structure of the dictionary is defined by an external specification.

**Table 3-14— S100\_GF\_CodelistAttributeType**

Role Name	Name	Description	Mult.	Type	Remarks
Class	S100_GF_CodelistAttributeType	Abstract base class for S100_Codelist attributes.	-	-	-
Tag	codelistType	Type of codelist	1	CharacterString	Must be one of: open enumeration open dictionary closed dictionary
Tag	URI	identifies the dictionary for open or closed dictionary codelists	0..1	CharacterString	Only for open or closed dictionary codelists
Tag	encoding	Encoding hint for extra values	0..1	CharacterString	Only for open enumeration or open dictionary codelists.

### 3-5.3.12 S100\_GF\_EnumerationType

S100\_GF\_EnumerationType and S100\_GF\_EnumerantClass together model the enumerations defining the allowed values for an enumeration attribute and their semantics. An instance of an enumeration type may define the set of allowed values for an enumeration or codelist attribute, or both.

## 3-5.4 Relationships between named types

### 3-5.4.1 Introduction

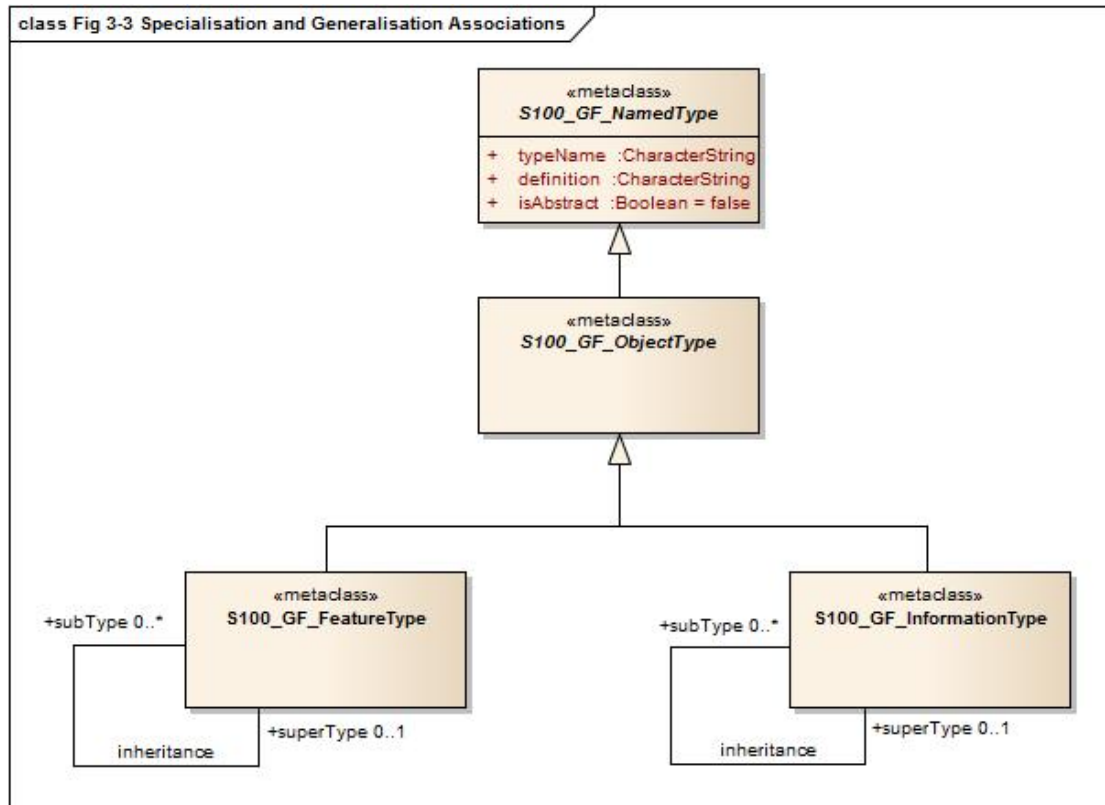
This subclause describes relationships between object types in more detail. Relationships are classified as follows:

- 1) Generalisation / Specialisation of feature types and information types.
- 2) Associations between feature types and information types.

### 3-5.4.2 GF\_InheritanceRelation

The class GF\_InheritanceRelation is not realised in the S-100 GFM but object inheritance is allowed through the use of an identical association on the class S100\_GF\_FeatureType and the class S100\_GF\_InformationType (see Figure 3-3). The multiplicity of the superType end of the association is such that a subtype may have only one supertype. This is to prevent the modelling of multiple inheritance. The inheritance relation association is modelled at the level of the concrete class rather than on the abstract class S100\_GF\_NamedType. This prevents a feature type inheriting from an information type and vice versa.

Inheritance associations exist only between named types (classes) and not between named type instances (i.e. entities occurring in a dataset).



**Figure 3-3 — Specialisation and Generalisation Associations**

### 3-5.4.3 S100\_GF\_AssociationType

Associations are defined by the class S100\_GF\_AssociationType with two roles and a definition. The ISO 19109 classes GF\_AggregationType, GF\_SpatialAssociationType, and GF\_TemporalAssociationType are not realised explicitly in the S-100 GFM. These classes can be used only if an association is allowed to carry properties. The ISO 19109 GFM allows this because GF\_AssociationType is a sub-type of GF\_FeatureType. However, S100\_GF\_AssociationType is not a sub-type of S100\_GF\_FeatureType.

### 3-5.4.4 Associations to information types

An association between S100\_GF\_ObjectType and S100\_GF\_InformationType is introduced in the S-100 GFM. The role additionalInformation is the default for this association in the S-100 GFM and means that additional information is available for a named type.

### 3-5.4.5 Default names for association ends

Application schemas may specify names for association ends (role names). If names are not explicitly provided, the following defaults shall be used.

- 1) If only one end of an association is given an explicit name "<rolename>", the other end shall have the default name "inv\_<rolename>".
- 2) If neither end of the association is given an explicit name, the default role name is "the<target class name>" in which the target class is referenced from the source class.
- 3) The above rules may not result in a distinct name for each association end in an application schema, so product specifications may define different or additional rules if needed.
- 4) If standard names are desired, the following defaults may be used instead of those listed above.
  - a. The role "additionalInformation" is a default role name for associations from feature to information types.

- b. Feature/feature or information/information associations navigable in only one direction may use the default end names “source” and “target”. The name “associatedWith” may be used at both ends of a bidirectional association.

Product specifications may mix individual and standard defaults but must be unambiguous about which name applies to any particular association end.

### 3-5.5 Behaviour of feature types

The behaviour of feature types is described by operations that may be performed upon or by instances of a feature type. Operations apply only to the interoperability model and do not apply to the data transfer model.

### 3-5.6 Constraints

Constraints may be introduced to ensure the integrity of the data. Constraints restrict the freedom in an application to prevent creation of erroneous data by specifying combinations of data that are either allowable or not allowable. An application schema shall identify constraints in an unambiguous manner.

Only named types and properties may have constraints.

## 3-6 Rules for application schema (ISO 19109 Clause 8)

### 3-6.1 The application modelling process (ISO 19109 Clause 8.1)

The application schema serves two purposes:

- 1) It achieves a common and correct understanding of the content and structure of data within a particular application field.
- 2) Secondly, it may provide a computer readable schema for applying automated mechanisms for data management.

The two roles imply a stepwise process for creating an application schema. The steps can be briefly described as:

- 1) Surveying the requirements from the intended field of application (Universe of Discourse)
- 2) Making a conceptual model of the application with concepts defined in the GFM. This task consists of identifying feature types, their properties and constraints.
- 3) Describing elements of the application schema in a formal modelling language where necessary. S-100 application schemas shall be described using the UML according to rules defined in this part of S-100.
- 4) Integrating the formal application schema with other standardized schemas, (spatial schema, quality schema, etc.) into a complete application schema.

### 3-6.2 The application schema (ISO 19109 Clause 8.2)

#### 3-6.2.1 Conceptual schema language for application schemas

If a conceptual language is used to design a S-100 application schema, then this must be UML.

#### 3-6.2.2 Main rules

The data structures of the application schema shall be modelled in the application schema.

All classes used within an application schema for data transfer shall be instantiable. This implies that the integrated class must not be stereotyped <<interface>>.

#### 3-6.2.3 Identification of application schemas

- 1) The identification of each application schema shall include a name and a version. The inclusion of a version ensures that a supplier and a user agree on which version of the application schema describes the contents of a particular dataset. A system of defining unique names and versions for S-100 application schemas shall be defined.

- 2) In UML, an application schema shall be described within a PACKAGE, which shall carry the name of the application schema and the version stated in the documentation of the PACKAGE.

### 3-6.2.4 Documentation of an application schema

- 1) An application schema shall be documented. A means of documenting application schemas for S-100 shall be defined in order to ensure consistency across S-100 product specifications.
- 2) The documentation of an application schema in UML may utilise the documentation facilities in the software tool that is used to create the application schema, if this information can be exported.
- 3) If a CLASS or other UML component corresponds to information in a feature catalogue, the reference to the catalogue shall be documented.
- 4) Documentation of feature types in an application schema shall be in a catalogue with a structure derived from the GFM, such as in a catalogue in accordance with S-100 Part 5. This could be in text format or XML accompanied by a style sheet (XSLT) used to create a text version.

### 3-6.3 Rules for application schema in UML (ISO 19109 Clause 8.3)

#### 3-6.3.1 Main rules (ISO 19109 Clause 8.3.1)

The main rules for application schemas in UML are:

- 1) An instance of S100\_GF\_NamedType shall be implemented as a CLASS.
- 2) An instance of S100\_GF\_ObjectType shall be implemented as a CLASS.
- 3) An instance of S100\_GF\_FeatureType shall be implemented as a CLASS.
- 4) An instance of S100\_GF\_InformationType shall be implemented as a CLASS.
- 5) An instance of S100\_GF\_FeatureAssociationType has the role of linkBetween in association to instances of S100\_GF\_FeatureType being implemented as CLASSES. It shall be implemented as one of the following cases:
  - a) Case 1: An instance of S100\_FeatureAssociationType that is not associated with any instances of S100\_GF\_ThematicAttributeType shall be implemented as an ASSOCIATION between these CLASSES.
  - b) Case 2: An instance of S100\_FeatureAssociationType that is associated with one or more instances of S100\_GF\_ThematicAttributeType shall be implemented as an ASSOCIATION CLASS; the associated instances of S100\_GF\_ThematicAttributeType shall be implemented as ATTRIBUTES of the ASSOCIATION CLASS.
- 6) An instance of S100\_GF\_InformationAssociationType has the role of informationLink in association to instances of S100\_GF\_FeatureType or S100\_GF\_InformationType being implemented as CLASSES. It shall be implemented one of the following cases:
  - a) Case 1: An instance of S100\_InformationAssociationType that is not associated with any instances of S100\_GF\_ThematicAttributeType shall be implemented as an ASSOCIATION between these CLASSES.
  - b) Case 2: An instance of S100\_InformationAssociationType that is associated with one or more instances of S100\_GF\_ThematicAttributeType shall be implemented as an ASSOCIATION CLASS; the associated instances of S100\_GF\_ThematicAttributeType shall be implemented as ATTRIBUTES of the ASSOCIATION CLASS.
- 7) An instance of S100\_GF\_AttributeType shall be implemented as an ATTRIBUTE.
- 8) An instance of S100\_GF\_SimpleAttributeType shall be implemented as an ATTRIBUTE.
- 9) An instance of S100\_GF\_ComplexAttributeType shall be implemented as a CLASS. The instantiated CLASS shall have one or more instances of S100\_GF\_SimpleAttributeType and/or S-100\_GF\_ComplexAttributeType as its ATTRIBUTE(s).

- 10) An instance of the association inheritanceRelation shall be represented by a UML GENERALISATION relationship.

### **3-6.4 Domain profiles of standard schemas in UML (ISO 19109 Clause 8.4)**

#### **3-6.4.1 Rules for adding information to a standard schema**

Standard schemas shall not be extended within application schemas. Standard schemas are those that are documented in S-100, e.g., the spatial schema, feature catalogue schema etc.

#### **3-6.4.2 Restricted use of standard schemas**

For some standard schemas, e.g. S-100 Part 7 (spatial schema), it is possible to redefine the schema in such a way that only selected parts of the schema will be used, and only some of the definitions of classes and relationships will be used.

- 1) Specification of a restricted profile of a standard schema shall be described in a new UML package by copying the actual definitions (classes and relationships) from the standard schema. Attributes and operations within classes may be omitted.
- 2) Reduction of a standard schema shall be in accordance of the conformance clause given for the actual standard.

#### **3-6.4.3 Rules for use of metadata schema (ISO 19109 Clause 8.5)**

The metadata schema defined in S100 Part 4 is an application schema for metadata data sets. Metadata are data describing and documenting data. Metadata for geographic data typically provides information about their identification, extent, quality, spatial and temporal aspects, spatial reference and distribution.

Metadata types shall be implemented as complex attributes that realise elements from S100 Part 4. Thus metadata attributes shall be thematic attribute types.

#### **3-6.4.4 Temporal rules (ISO 19109 Clause 8.6)**

S-100 does not include a profile of ISO 19108. Temporal attributes shall be modelled using the types Date, Time or DateTime, S100\_TruncatedDate, or complex attributes using combinations of these temporal types. Use of these types makes the attribute an instance of S100\_GF\_SimpleAttributeType or S100\_GF\_ComplexAttributeType, as appropriate.

### **3-6.5 Spatial rules (ISO 19109 Clause 8.7)**

#### **3-6.5.1 General spatial rules (ISO 19109 Clause 8.7.1)**

The value domain of spatial attribute types shall be in accordance with the specifications given by S-100 Part 7, which provides conceptual schemas for describing the spatial characteristics of features and a set of spatial operators consistent with these schemas.

S-100 Part 7 explicitly excludes topological primitives and consequently any topology rules set out in clause 8.7 of ISO 19109 are not relevant in this profile.

#### **3-6.5.2 Spatial attributes**

- 1) Spatial characteristics of a feature shall be described by one or more spatial attributes. In an application schema, a spatial attribute is a subtype of a feature attribute (see 5.3), and the taxonomy of its values is defined in the S-100 Part 7.
- 2) A spatial attribute shall be represented in an application schema in either of two ways:
  - a) Case 1: as an ATTRIBUTE of a UML CLASS that represents a feature, in which case the ATTRIBUTE shall take one of the spatial objects defined in the spatial schema, ISO 19107, as the data type for its value, or
  - b) Case 2: as a UML ASSOCIATION between the class that represents a feature and one of the spatial objects defined in the spatial schema, ISO 19107.
- 3) A spatial attribute shall take a spatial object as its value. Spatial objects are classified as geometric objects, which are sub-classed as primitives, complexes or aggregates (for geometric objects). The value types of spatial attributes must be the types described in Part 7, or their subtypes..

### 3-6.5.3 Spatial Quality

The positional quality of a spatial object shall be described by a one way association to a S100\_GF\_InformationType which is associated with a S100\_GF\_SimpleAttribute carrying positional accuracy.

### 3-6.5.4 Geometric aggregates and complexes to represent spatial attributes of features

#### 3-6.5.4.1 Introduction

The spatial configuration of many features cannot be represented by a single geometric primitive. The types GM\_Aggregate and GM\_Complex support the representation of such features as collections of geometric objects.

#### 3-6.5.4.2 Geometric aggregates

The spatial profile of S-100 only supports the GM\_Multipoint geometric aggregate type. GM\_Multipoint shall be used as the value of a spatial attribute that represents a feature as a set of points.

#### 3-6.5.4.3 Geometric complexes

Geometric complexes are used to represent the spatial characteristics of a feature as a set of connected geometric primitives. In addition, instances of GM\_Complex allow geometric primitives to be shared by the spatial attributes of different features. There are no explicit links between the GM\_Primitives in a GM\_Complex; the connectivity between the GM\_Primitives can be derived from the coordinate data.

- 1) A GM\_Complex shall be used as the value for a spatial attribute that represents a feature as a collection of connected GM\_Objects, which are disjoint except at their boundaries. Subclasses of GM\_Complex may be specified to constrain the structure of the GM\_Complex used to represent a particular spatial configuration.
- 2) Features that share elements of their geometry shall be represented as GM\_Complexes that are subcomplexes within a larger GM\_Complex.

#### 3-6.5.4.4 Geometric composites

A geometric composite is a geometric complex that has all the properties of a geometric primitive except that it is composed of smaller geometric primitives of the same kind. Geometric composites are used to represent complex features that are composed of smaller geometric objects that have the same kind of geometry. A GM\_Composite shall be used to represent a complex feature that has the geometric properties of a geometric primitive.

#### 3-6.5.4.5 Features sharing geometry

Different features can share, partly or completely, the same geometry when they appear to occupy the same position. To share a common geometry, spatial feature attributes must share one or more GM\_Objects.

There are two ways to share geometry. Complete sharing occurs when two feature instances both take the same instance of a GM\_Object as the value of a spatial attribute. This can be required, or precluded, by stating a constraint in the application schema. In the absence of such constraints, it may be done whenever necessary.

- 1) An application schema may require instances of two or more feature types to share their geometry completely by including a constraint that the GM\_Objects representing the features must be equal.
- 2) An application schema may preclude instances of two or more feature types from sharing their geometry completely by including a constraint that the GM\_Objects representing the features are not equal.

## 3-6.6 Cataloguing rules (ISO 19109 Clause 8.8)

### 3-6.6.1 Introduction (ISO 19109 Clause 8.8.1)

A feature catalogue is a repository that describes real world phenomena of significance to a particular domain. A feature cataloguing methodology provides the details about the



organisation of the data that represents these phenomena in categories so that the resulting information is as unambiguous, comprehensible and useful as possible.

### 3-6.6.2 Application schema based on a feature catalogue (ISO 19109 Clause 8.8.2)

An S-100 application schema shall be completely constructed by the definitions provided by a feature catalogue implementing the S-100 feature catalogue profile.

### 3-6.6.3 Character encoding

The character encoding used in a dataset shall be defined in the application schema. Where more than one character encoding is used the application schema shall document how they are used in the dataset.

### 3-6.7 Codelists

Application schemas which use an attribute of codelist type shall include a CLASS with tags as specified below. The codelist types are described in Part 1.

**Table 3-15 — Tags for codelist types**

Codelist type	Tags and values
open enumeration	codelistType=open enumeration encoding=other: [something]
closed dictionary	codelistType=closed dictionary URI=<dictionary URL>
open dictionary	codelistType=open dictionary URI=<dictionary URL> encoding=other: [something]

The normative form of the “other: [something]” encoding shall be a character string in the format specified below:

The word ‘other’ followed by a colon and a single space character (i.e., ‘other:’ without quotes), followed by one or more alphanumeric strings separated by single spaces.

The normative pattern specifying the portion following ‘other:’ is specified as (using XML Schema 1.0/1.1 patterns):

`[a-zA-Z0-9]+( [a-zA-Z0-9]+)*`

Note that the left parenthesis is followed by a single space and the pattern ends with the asterisk.

#### Examples:

**Table 3-16 — Examples of “extra” values for codelist attributes**

other: loxodromic	allowed
other: Seeschifffahrtsstraßen Ordnung	not allowed (contains the character ß which is not in the allowed set)
other: German Shipping Regulations	allowed
other: German Shipping Regulations	not allowed (2 consecutive spaces)
German Shipping Regulations	not allowed (does not begin with “other:”)
other: 287	allowed
other: 1,3,5-Trinitroperhydro-1,3,5-triazine	not allowed (hyphen and comma characters are not in the allowed set)

## **3-7 Application Schema for Coverages**

### **3-7.1 Introduction**

This rule set for application schemas is aimed at application schemas for feature oriented data. However, application schemas may also be defined for coverages.

This section includes examples of how application schemas may be defined for imagery and gridded data. The components of the application schemas are defined in ISO 19123 not ISO 19109. However, a coverage may be based on feature type geometries and, in such cases, is conceptually similar to a feature collection. Such feature oriented coverages are discussed below.

### **3-7.2 Gridded Data**

This application schema defines a quadrilateral grid coverage with associated metadata. The metadata is generically referenced to ISO 19115 and 19115-2. A specific choice of metadata has not been made in this schema. This schema can serve for both "matrix" and "raster" data according to the metadata chosen.

The gridded data consists of a single feature - the "image" or "matrix" together with associated metadata taken from MD\_Metadatas (or MI\_Metadatas). The CV\_Coverage serves as the spatial attribute of the gridded data set. It defines an area that is "covered" by the coverage function. For the continuous coverage defined in this application schema, the coverage function returns a value for every point in the area covered based on an interpolation function. The Grid Value Matrix is a set of values which drives the interpolation function. In this case the value matrix is a grid traversed by a linear scan (x,y) traversal rule. The spatial referencing is defined by the coordinate reference system.

This template application schema supports the majority of imagery and gridded data applications.

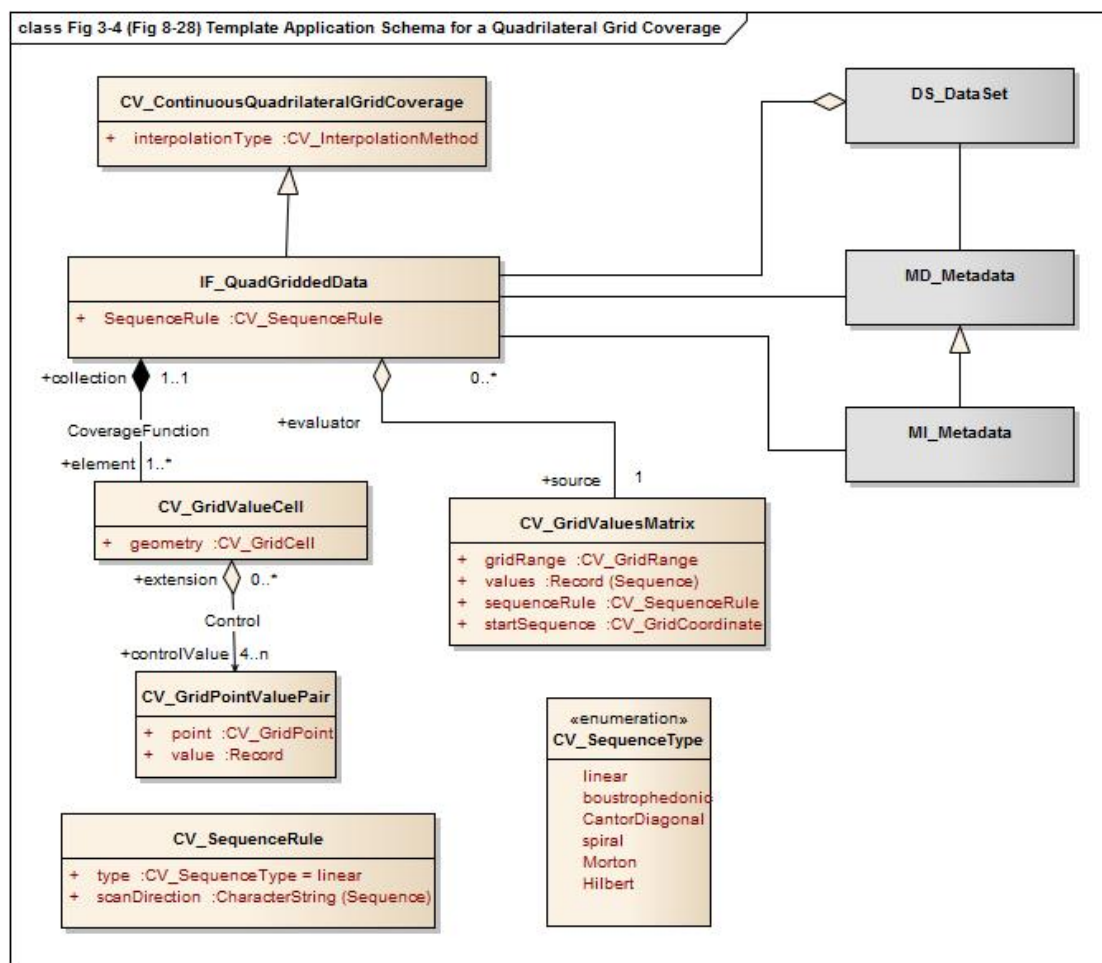


Figure 3-4 – Template application schema for a Quadrilateral Grid Coverage

### 3-7.3 Variable Cell Size Grid

This application schema describes a grid of variable cell size (ISO 19123). The traversal order is the Morton order in order to permit support of three (or more) dimensions. This is of particular use for hydrographic data where large volumes of sonar data result in an extensive bottom cover in a 3D grid, but where the cells of similar depth can easily be aggregated.

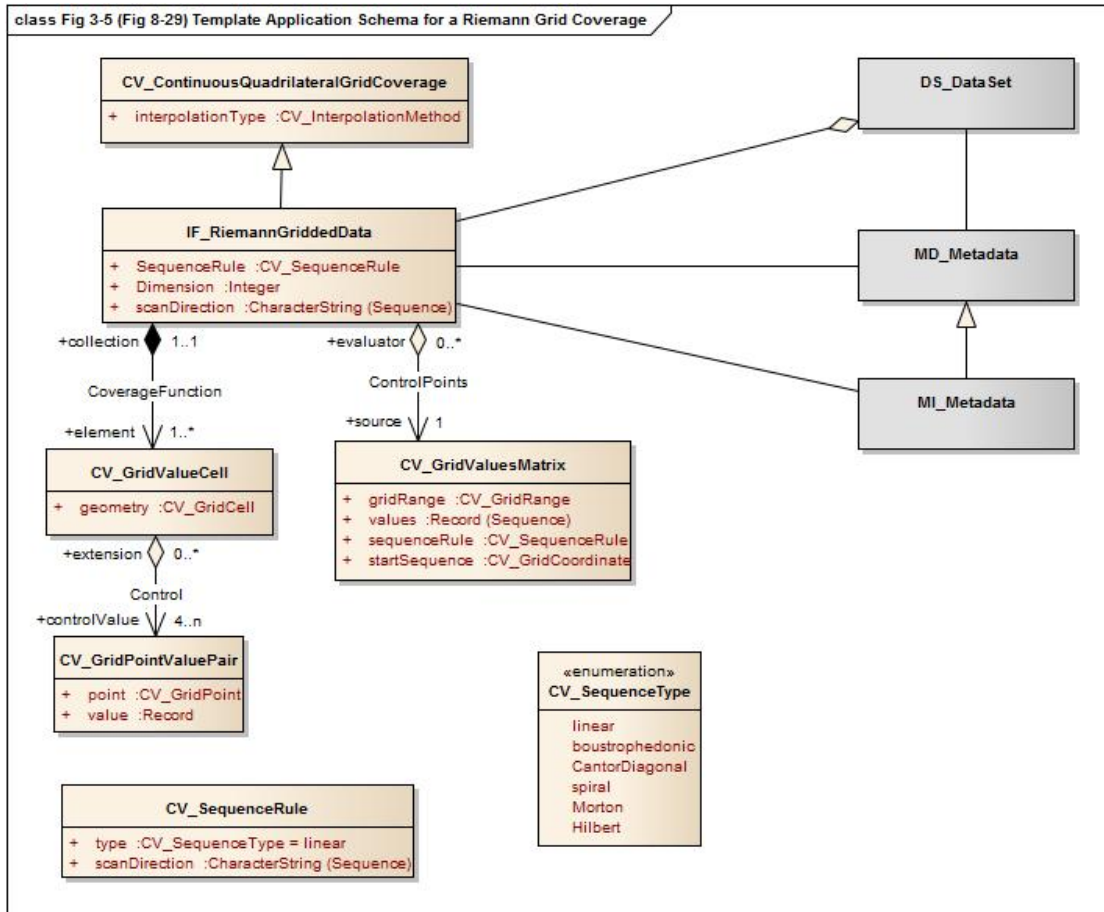
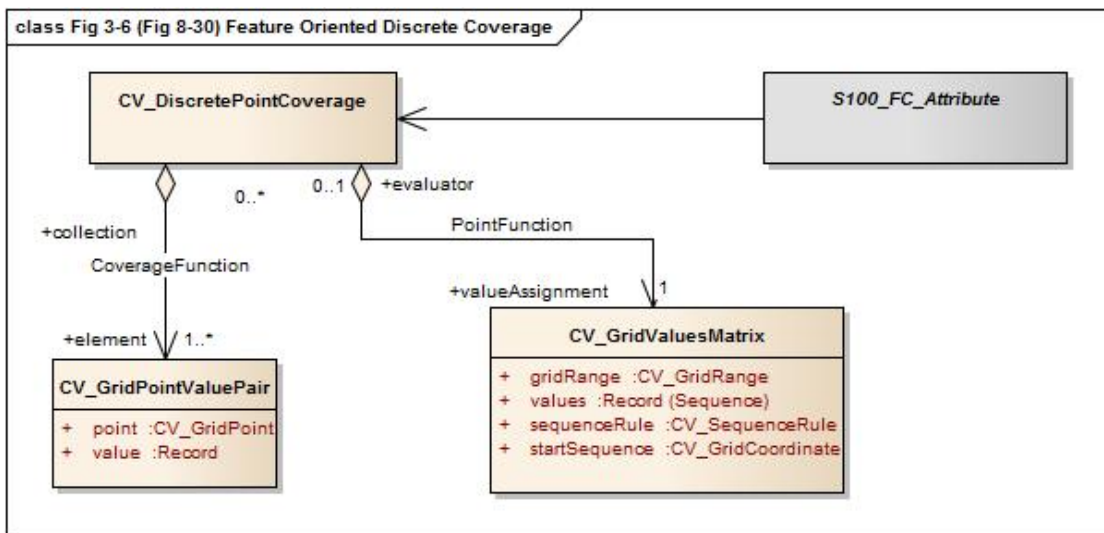


Figure 3-5 – Template application schema for a Reimann Grid Coverage

### 3-7.4 Feature Oriented Image

All gridded data sets are feature oriented, in that a coverage is a subtype of a feature. This means that an entire gridded data set can be considered to be a single feature. A feature structure can be applied to gridded data in two different ways. First, a discrete coverage can carry a feature code as an attribute. For example, a coverage corresponding to the postal code system will have discrete values for each postal code, yet still cover the country completely. The only difference in the application schema is a relationship between the discrete coverage and the feature.



### Figure 3-6 – Feature oriented discrete coverage

The second method of establishing a feature structure is to develop a composite data set that contains many separate but adjoining coverages. The coverages may be continuous or discrete. This is very much like the way a "vector" data set is composed where each feature has its own geometry and attributes. In fact vector data may be mixed with coverage data in the same data set. The application schema simply allows multiple instances of feature.

Geometric elements such as grids may be shared between multiple features, and features may be related by composition or other relationships as allowed in the general feature model of ISO 19109. A complex feature may include both a continuous grid coverage and vector data such as a polygonal boundary. A feature oriented data set may contain both a continuous coverage of the ocean as collected by sonar, and point and line features corresponding to navigational aids. Topological primitives may relate all of the features. This allows for some interesting and useful structures. A Raster Nautical Chart may include additional vector data describing the navigational aids, hazards and danger zones, which are not "visible" in that they are not portrayed, but which are active in the use of the Raster Nautical Chart, so the mariner can determine whether a ship is within a danger zone, or perform other ECDIS functions.

### 3-8 Interpretation of models of time intervals and period

The start and end instants of periods (and intervals) shall be included in the period (or interval) unless a product specification specifies a different interpretation. This is based on ISO 8601:2004 § 2.1.3 which defines time interval as "the part of the time axis delimited by two instants" and provides that "A time interval comprises all instants between the two limiting instants and, unless otherwise stated, the two limiting instants themselves". Use of "before" or "after" attributes for intervals is not permitted.

The start and end instants are defined by the data/time component of smallest granularity. For example, if the month is the smallest component given in an end instant, the end instant is the whole month and the interval ends at the end of the last day of the month.

Examples: Applying this to encoding intervals using the reduced accuracy representation or the truncatedDate type, results in the interpretations in Table 3-17. The table also indicates how the special case of leap years can be handled.

**Table 3-17 — Examples of periods**

<S100_TruncatedDateAttributeType> periodStart	----01--	000000 on January 1 through 240000 on the 29th day of February in leap years and the 28th day of February in non-leap years
	year and day not encoded	
<S100_TruncatedDateAttributeType> periodEnd	----02--	000000 on January 1 through 240000 on the 28th day of February each year
	year and day not encoded	
<S100_TruncatedDateAttributeType> periodStart	----0101	000000 on January 5, 2012 through 240000 on
	year not encoded	
<S100_TruncatedDateAttributeType> periodEnd	----0228	
	year not encoded	
<S100_DateAttributeType> dateStart	dateStart=20120105	

<S100_DateAttributeType> dateEnd	dateEnd=20120618	June 18, 2012
-------------------------------------	------------------	---------------

### 3-9 Use of format-specific types for truncated dates

Data formats may utilise specific types as supported by that format in order to incorporate truncated values. Where this occurs the format description must specify the mapping between the truncatedDateType values and those of the format-specific types.

#### Example:

An XML based encoding may use the *gMonthDay* simple attribute type (which is an XML Schema built-in type) as an equivalent representation for “December 17 each year”:

xs:gMonthDay: --12-17

This is equivalent to the value ----1217 in a data format which adheres strictly to S-100.

# **S-100 – Part 4a**

## **Metadata**

## Contents

4a-1	Scope .....	1
4a-2	Conformance.....	1
4a-2.1	Conformance of this Profile with other Standards .....	1
4a-3	Conformance to this Profile.....	2
4a-4	Normative References .....	2
4a-4.1	Profile definition.....	2
4a-5	Requirements .....	3
4a-5.1	Business purpose and Intended use.....	3
4a-5.2	Metadata for describing geographic data and other resources .....	4
4a-5.3	Obligations/conditions .....	4
4a-5.4	Minimum metadata requirements .....	5
4a-5.5	Core metadata for geographic datasets.....	9
4a-5.6	Variations and preferences .....	10
4a-5.6.1	Metadata element fileIdentifier .....	10
4a-5.6.2	Metadata element parentIdentifier .....	11
4a-5.6.3	Geographic extent of the dataset.....	11
4a-5.6.4	Data and Date Time information .....	11
4a-5.6.5	Metadata extension information.....	12
Appendix 4a-A	Metadata Entity Set Information.....	13
Appendix 4a-B	Data Dictionary .....	15
Appendix 4a-C	Metadata Implementation .....	16
Appendix 4a-D	Discovery Metadata for Information Exchange Catalogues .....	17



## 4a-1 Scope

The S-100 metadata profile described in parts 4a, 4b and 4c provides a specification for describing, validating and exchanging metadata about geographic datasets commonly produced by hydrographic organizations. Its purpose is the creation of metadata records that provide information about the identification, spatial and temporal extent, quality, application schema, spatial reference system, and distribution of digital geographic data. It is applicable to the cataloguing of datasets, clearinghouse activities, and the full description of geographic and non-geographic resources. Although it is primarily intended to describe digital geographic data, it may also be used to describe other resources such as charts, maps, images, textual documents and non-geographic resources. It makes provision for the description of; *attributes*, *attributeTypes*, *features*, *featureTypes*, *collectionHardware*, *collectionSession*, *datasets*, *dataset series*, *nonGeographicDatasets*, *propertyTypes*, *fieldSession*, *software* and *services*. It should be noted that this profile is not limited to the resources listed in the ISO 19115 codelist *MD\_ScopeCode* <<Codelist>> (ISO 19115 - B.5.25), and can be extended to include additional resources if required.

This profile is based on ISO 19115:2003 Metadata and 19115 Part 2 - Metadata for imagery and gridded data. It also takes account of ISO/TS 19139 Metadata – XML schema implementation.

ISO 19115 provides an abstract structure for describing digital geographic information by defining metadata elements and establishing a common set of metadata terminology, definitions, and extension procedures. ISO/TS 19139 provides an eXtensible Markup Language (XML) implementation of ISO 19115, and guidance for developing profiles and extensions. It should be noted that this profile is not limited to the resources listed in the ISO 19115 codelist *MD\_ScopeCode* <<Codelist>> (ISO 19115 - B.5.25), and can be extended to include additional resources if required.

This document is intended for developers and implementers of metadata applications, and provides a basic understanding of the principles and the overall requirements for standardisation of geographic information. It should be used in conjunction with the standards listed under clause 4a-4 – Normative references.

Further information concerning S-100 metadata implementation, encoding and quality principles are included in the following associated documents.

- 1) S-100 Part 4b – Metadata Extensions for Imagery and gridded data
- 2) S-100 Part 4c – Metadata Quality Principles
- 3) Appendix 4a–C - Metadata Implementation

## 4a-2 Conformance

### 4a-2.1 Conformance of this Profile with other Standards

In addition to the elements listed in ISO 19115:2005, this profile also adopts all associated 19115 obligations and conditions, with the exception of the *fileIdentifier* element which has been changed from optional to mandatory. This has been done to facilitate the implementation and management of metadata records by allowing instances of duplicate metadata records to be identified, and defining the relationship of a child metadata record with its parent metadata record. The specifics of any metadata hierarchy relationships will be detailed in the product specifications.

Taking into account the change identified above, and the requirements documented in ISO 19106:2004, this Profile meets the requirements of conformance class 11. The Profile is a

---

<sup>1</sup> Conformance class 1 as described at Section 2 *Conformance* and Appendix B.3 *Example of a profile with specialisations* (ISO 19106:2004).

subset<sup>2</sup> of ISO 19115:2005 and includes an extension in the context permitted by the base standard<sup>3</sup>.

This profile includes *parentIdentifier* as a core metadata element for geographic datasets. If a dataset metadata record has a parent metadata record, then this element becomes mandatory and therefore should be considered a 'core' element. Guidance on the XML implementation of this profile is included at Appendix 4a-C.

### 4a-3 Conformance to this Profile

Any metadata claiming conformance to this Profile shall:

- 1) have content according to the data dictionary definitions in Annex B of ISO 19115:2005, (including changes required by ISO 19115:2003/Cor.1:2006) with the exception of the metadata element *fileIdentifier* which has a mandatory obligation;
- 2) prove conformance by validating XML document instances against the S-100 Metadata Profile schemas which are available from the IHO website at Profiles based on this Profile

All product specific implementations of this profile shall provide an Extensible Stylesheet Language (XSL) transform file/resource that can translate the XML document instances into the S-100 Metadata Profile XML format. These resulting XML document instances shall be validated using the ISO/TS 19139:2007 XSDs.

### 4a-4 Normative References

The following referenced documents are required for the application of this document. For dated references, only the edition cited applies. For undated references, the latest edition of the referenced document (including amendments) applies.

#### 4a-4.1 Profile definition

The following documents were the references used to define the S-100 Metadata Profile:

ISO 19115:2005, Geographic information – Metadata.

ISO 19115:2003/Cor.1:2006, Geographic information - Metadata - Technical Corrigendum 1

ISO 19115-2:2006 - Geographic information - Metadata - Part 2: Extensions for imagery and gridded data.

ISO 19119:2005 - Geographic information – Services.

ISO/TS 19139:2007, Geographic information - Metadata - XML schema implementation.

---

<sup>2</sup> A profile of a single base standard can include a subset, which is equivalent to the entire base standard. That is, a subset can equal the whole (19106:2005, p15).

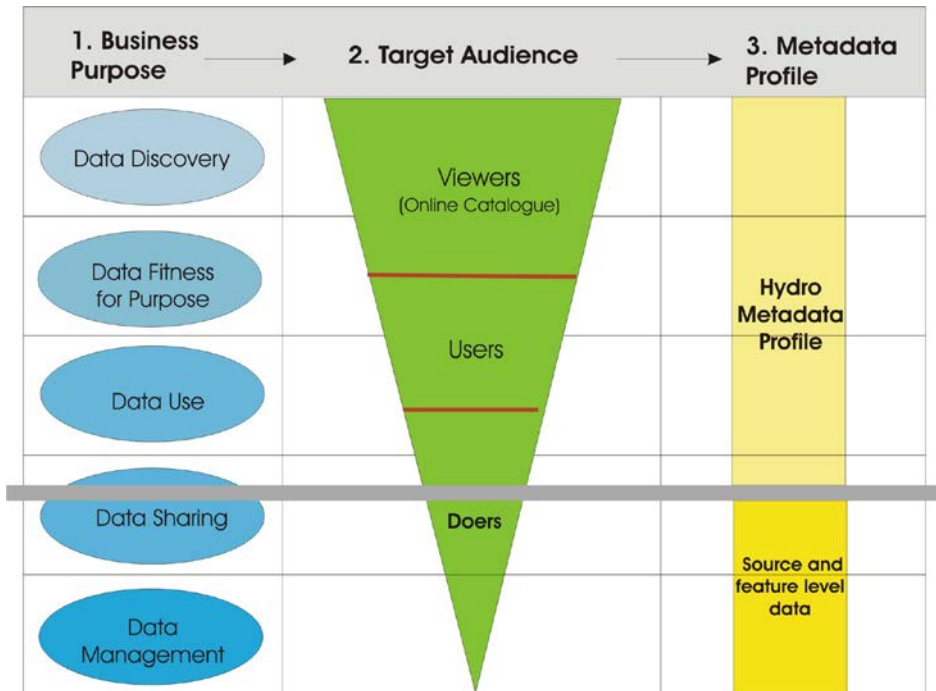
<sup>3</sup> This conforms to the rules included at Annex C.6 (ISO 19115:2005).

## 4a-5 Requirements

### 4a-5.1 Business purpose and Intended use

Metadata can satisfy a number of uses:

- 1) Data Discovery - summary descriptions of content and quality, contact details, off-line distribution and on-line references (URL) for on-line viewing.
- 2) Data use - more extensive information on data coverage, maintenance, content and details of data creation. It includes additional contact, distribution and quality details.
- 3) Data Fitness – additional detail about use, limitations, format, age, and extents. This level of metadata assists the user to determine the data’s suitability for use.
- 4) Data Sharing – further detail relating to data content, transfer formats, and spatial representation.
- 5) Data Management – the most detailed level of metadata, which includes information on the data quality regimes and data quality test results. This type of information is sometimes important when data is exchanged between organizations.



**Figure 4a-1— Business Purpose**

Figure 4a-1 above illustrates the relationship between the types of metadata required by different user communities, and the scope of this profile. Each S-100 based product specification will describe the source and feature-level metadata that will be required to support data use, data sharing, and data management. The more demanding requirements for comprehensive metadata (as illustrated by “Doers” in Figure 4a-1), require further attribution to allow source selection and feature analysis.

ISO 19115 does not provide all the metadata necessary to describe imagery. This has been included in part 2 to ISO 19115, which incorporates elements that are needed for the description of imagery and gridded data. ISO 19130 – “Sensor and data model for imagery and gridded data”, is an important standard associated with ISO 19115 Part 2, as it specifies the information required to support the geolocation of georeferenceable imagery, including a sensor description and associated physical information defined by a sensor model, fitting functions, and ground control points. It describes how the sensor measurements and the

geolocation information are logically associated. In particular, ISO 19130 describes the sensor and data model for hydrographic sonar requirements, and the associated metadata. This will be described in relevant product specifications.

An XML implementation of the ISO 19115 which describes how the abstract UML models in ISO 19115 and 19115 Part 2 are converted into XML is documented in ISO publication ISO/TS 19139.

Although this profile is largely based on the above mentioned standards, reference to additional standards will need to be made. (See sections – “Normative References”).

This Profile defines:

- 1) mandatory and conditional metadata sections, metadata entities, and metadata elements
- 2) the minimum set of metadata elements for any resource in order to conform to this Profile
- 3) the core metadata for geographic datasets
- 4) optional metadata elements that allow for a more extensive standard description of resources
- 5) the option to extend the Profile to cater for specialised needs.

Implementation of the Profile is based on ISO/TS 19139:2007, and includes;

- 1) the use of the ISO/TS 19139:2007 XSDs,
- 2) XML documents containing dictionaries to implement the ISO 19115:2005 codelists (XML data dictionaries of the ISO 19115:2003 codelists in GML format),
- 3) XML data dictionaries of the S-100 Geographic Extent Names and Search Words.<sup>4</sup>

While the UML class *S100\_Metadata* specialises the class *MD\_Metadata*, the specialisation only involves restrictions of the parent class. Hence, for the purpose of XML implementation, the *MD\_Metadata* element shall be used to support interoperability with other ISO 19100 standards for geographic information. This follows the recommendation in ISO/TS 19139:2007 Annex A.4.

#### 4a-5.2 Metadata for describing geographic data and other resources

The Profile identifies the metadata required to describe digital geographic data and resources, and is applicable to independent datasets, dataset aggregations, geographic features, feature classes and attributes. Metadata is documented via the creation of XML document instances, which are validated against the S-100 Metadata Profile XSDs, and relevant codelists and enumerations<sup>5</sup>.

Metadata records must contain a minimum set of core elements (see Section 4a-5.3 which are necessary for conformance with this Profile. A number of additional elements required for discovery purposes have also been identified and are described in the Appendix 4a-C. Quality information is important for assessing whether datasets or resources are fit for use, and quality metadata have therefore been documented in part 4c.

#### 4a-5.3 Obligations/conditions

Obligation descriptors have been included to provide an indication of whether a metadata entity or element must be documented or may be conditionally or unconditionally left to the

<sup>4</sup> Reference to values documented in the S-100 Metadata encoding guide. They do not appear in the ISO 19115:2003 codelists.

<sup>5</sup> Enumeration: a fixed list of valid identifiers of named literal values. Attributes of an enumerated type may only take values from this list (source: ISO 19136:\_\_, *Geographic information — Geography Markup Language (GML)*)

discretion of the metadata encoder. This descriptor may have the following values: M (mandatory), C (conditional) or O (optional). The following definitions from section B.1.5 *Obligation/Condition* of ISO 19115:2005 are included below.

A **mandatory (M)** obligation means the metadata entity or metadata element shall be documented.

A **conditional (C)** obligation specifies an electronically manageable condition under which at least one metadata entity or a metadata element is mandatory. 'Conditional' is used for one of the three following possibilities:

- 1) Expressing a choice between two or more options. At least one option is mandatory and must be documented.
- 2) Documenting a metadata entity or a metadata element if another element has been documented.
- 3) Documenting a metadata element if a specific value for another metadata element has been documented.

If the answer to the condition is positive, then the metadata entity or the metadata element shall be mandatory.

An **optional (O)** obligation means that the metadata entity or the metadata element may be documented or may not be documented. Optional metadata entities and optional metadata elements have been defined to provide a guide to those looking to fully document their data. (Use of this common set of defined elements will help promote interoperability among geographic data users and producers world-wide.) If an optional entity is not used, the elements contained within that entity (including mandatory elements) will also not be used. Optional entities may have mandatory elements; those elements only become mandatory if the optional entity is used.

#### 4a-5.4 Minimum metadata requirements

The minimum requirements for recording metadata include a number of elements that must be completed in order to conform to this Profile. It should be noted that the obligation is not mandatory for all elements, however some conditional elements may become mandatory under certain conditions (e.g. *hierarchyLevel*).

Table 4a-1 identifies the minimum set of metadata elements that should be completed for datasets and other resources. These elements also form part of the core metadata for geographic datasets listed in Table 4a-2.

**Table 4a-1 — Minimum metadata for geographic datasets and other resources**

<b>Name</b>	<b>Path</b>	<b>Datasets</b>	<b>Other resources</b>
Metadata file identifier	MD_Metadata.fileIdentifier	<b>M</b>	<b>M</b>
Metadata language	MD_Metadata.language	<b>C</b> (documented if not defined by the encoding process)	<b>C</b> (same as for dataset)
Metadata character set	MD_Metadata.characterSet	<b>C</b> (documented if ISO 10646-1, is not used and not defined by the encoding process)	<b>C</b> (same as for dataset)
Metadata file parent identifier	MD_Metadata.parentIdentifier	<b>C</b> (documented if the hierarchy of a higher level exists)	<b>C</b> (same as for dataset)
Metadata hierarchy level	MD_Metadata.hierarchyLevel	<b>O</b> (assumed to be 'dataset' if MD_Metadata.hierarchyLevel is omitted)	<b>M</b> (documented if hierarchyLevel not = 'dataset')
Metadata hierarchy level name	MD_Metadata.hierarchyLevelName	<b>O</b> (assumed to be 'dataset' if MD_Metadata.hierarchyLevelName is omitted)	<b>M</b> (documented if hierarchyLevel not = 'dataset')
Metadata contact individual name	MD_Metadata.contact > CI_ResponsibleParty.individualName	<b>C</b> (documented if 'organisationName' and 'positionName' not documented)	<b>C</b> (same as for dataset)
Metadata contact organisation	MD_Metadata.contact > CI_ResponsibleParty.organisationName	<b>C</b> (documented if 'individualName' and 'positionName' not documented)	<b>C</b> (same as for dataset)

Name	Path	Datasets	Other resources
Metadata contact position	MD_Metadata.contact > CI_ResponsibleParty.positionName	<b>C</b> (documented if 'individualName' and 'organisationName' not documented)	<b>C</b> (same as for dataset)
Metadata contact role	MD_Metadata.contact > CI_ResponsibleParty.role > CI_RoleCode	<b>M</b>	<b>M</b>
Metadata date stamp	MD_Metadata.dateStamp	<b>M</b>	<b>M</b>
Resource title	MD_Metadata.identificationInfo > MD_DataIdentification.citation > CI_Citation.title	<b>M</b>	<b>M</b> (See note 2)
Resource reference date	MD_Metadata.identificationInfo > MD_DataIdentification.citation > CI_Citation.date > CI_Date.date	<b>M</b>	<b>M</b> (See note 2)
Resource reference date type	MD_Metadata.identificationInfo > MD_DataIdentification.citation > CI_Citation.date > CI_Date.dateType > CI_DateTypeCode	<b>M</b>	<b>M</b> (See note 2)
Abstract describing the resource	MD_Metadata.identificationInfo > MD_DataIdentification.abstract	<b>M</b>	<b>M</b> (See note 2)
Resource language	MD_Metadata.identificationInfo > MD_DataIdentification.language	<b>M</b>	<b>C</b> (only used if MD_DataIdentification has been used)
Resource character set	MD_Metadata.identificationInfo > MD_DataIdentification.characterSet	<b>C</b> (documented if ISO 10646-1 is not used)	<b>C</b> (documented if ISO 10646-1 is not used)
Topic category	MD_Metadata.identificationInfo > MD_DataIdentification.topicCategory	<b>M</b>	<b>C</b> (if hierarchyLevel = 'series' topicCategory is mandatory)
Geographic location of the resource (by description)	MD_Metadata.identificationInfo > MD_DataIdentification.extent > EX_Extent > EX_GeographicDescription.geographicIdentifier >	<b>C</b> (See notes 3 and 4)	<b>O</b> (See note 4)

Name	Path	Datasets	Other resources
	MD_Identifier.code		
West longitude	MD_Metadata.identificationInfo > MD_DataIdentification.extent > EX_Extent > EX_GeographicBoundingBox.westBoundLongitude	<b>C</b> (See notes 3 and 4)	<b>O</b> (See note 4)
East longitude	MD_Metadata.identificationInfo > MD_DataIdentification.extent > EX_Extent > EX_GeographicBoundingBox.eastBoundLongitude	<b>C</b> (See notes 3 and 4)	<b>O</b> (See note 4)
South latitude	MD_Metadata.identificationInfo > MD_DataIdentification.extent > EX_Extent > EX_GeographicBoundingBox.southBoundLatitude	<b>C</b> (See notes 3 and 4)	<b>O</b> (See note 4)
North latitude	MD_Metadata.identificationInfo > MD_DataIdentification.extent > EX_Extent > EX_GeographicBoundingBox.northBoundLatitude	<b>C</b> (See notes 3 and 4)	<b>O</b> (See note 4)

NOTE1 ISO 10646-1 - Information technology — Universal Multiple-Octet Coded Character Set (UCS)

NOTE2 MD\_ServiceIdentification may be used instead of MD\_DataIdentification if hierarchyLevel = 'service'

NOTE3 For a geographic dataset, include metadata for the geographic bounding box (West longitude, East longitude, South latitude and North latitude) or the geographic description identifier (The use of geographic bounding box is recommended - see Section 5.6.3).

NOTE4 If any one of west longitude, east longitude, south latitude or north latitude exists, then the remaining three must also be completed



#### 4a-5.5 Core metadata for geographic datasets

Although ISO 19115:2005 defines an extensive set of metadata elements, only a subset of these are used. It is essential however that a minimum number of metadata elements be maintained for a dataset (as listed in Table 4a-1). When describing geographic datasets however, it is recommended that additional metadata elements (in addition to the minimum requirements for geographic datasets) be used. This set of metadata, which includes the minimum set of metadata and some additional optional elements, is referred to as **core metadata**. Table 4a-2 lists the core metadata required to describe a *dataset*, typically for catalogue purposes. This list contains metadata answering the following questions:

- 1) 'Does a dataset on a specific topic exist ("what")?'
- 2) 'For a specific place ("where")?'
- 3) 'For a specific date or period ("when")?'
- 4) 'A point of contact to learn more about or order the dataset ("who")?'

By using the core metadata described below, interoperability will be enhanced, and potential users should be able to understand without ambiguity the characteristics of geographic datasets or resources.

**Table 4a-2 — Core metadata for geographic datasets**

Name	Path	Obligation
Metadata file identifier	MD_Metadata.fileIdentifier	M <sub>a</sub>
Metadata language	MD_Metadata.language	C <sub>b</sub>
Metadata character set	MD_Metadata.characterSet	C <sub>c</sub>
Metadata file parent identifier	MD_Metadata.parentIdentifier	C <sub>d</sub>
Metadata point of contact	MD_Metadata.contact > CI_ResponsibleParty	M
Metadata date stamp	MD_Metadata.dateStamp	M
Metadata standard name	MD_Metadata.metadataStandardName	O
Metadata standard version	MD_Metadata.metadataStandardVersion	O
Dataset title	MD_Metadata.identificationInfo > MD_DataIdentification.citation > CI_Citation.title	M
Dataset reference date	MD_Metadata.identificationInfo > MD_DataIdentification.citation > CI_Citation.date	M
Abstract describing the data	MD_Metadata.identificationInfo > MD_DataIdentification.abstract	M
Dataset responsible party	MD_Metadata.identificationInfo > MD_DataIdentification.pointOfContact > CI_ResponsibleParty	O
Spatial representation type	MD_Metadata.identificationInfo > MD_DataIdentification.spatialRepresentationType	O
Spatial resolution of the dataset	MD_Metadata.identificationInfo > MD_DataIdentification.spatialResolution > MD_Resolution.distance or MD_Resolution.equivalentScale	O <sub>e</sub>
Dataset language	MD_Metadata.identificationInfo > MD_DataIdentification.language	M

Name	Path	Obligation
Dataset character set	MD_Metadata.identificationInfo > MD_DataIdentification.characterSet	C f
Dataset topic category	MD_Metadata.identificationInfo > MD_DataIdentification.topicCategory	M
Geographic location of the dataset (by four coordinates or by description)	MD_Metadata.identificationInfo > MD_DataIdentification.extent > EX_Extent > EX_GeographicBoundingBox or EX_GeographicDescription	C g, h
Temporal extent information for the dataset	MD_Metadata.identificationInfo > MD_DataIdentification.extent > EX_Extent.temporalElement	O
Vertical extent information for the dataset	MD_Metadata.identificationInfo > MD_DataIdentification.extent > EX_Extent.verticalElement > EX_VerticalExtent	O
Lineage	MD_Metadata.dataQualityInfo > DQ_DataQuality.lineage > LI_Lineage	O
Reference system	MD_Metadata.referenceSystemInfo > MD_ReferenceSystem.referenceSystemIdentifier > RS_Identifier	O
Distribution Format	MD_Metadata.distributionInfo > MD_Distribution > MD_Format	O
On-line resource	MD_Metadata.distributionInfo > MD_Distribution > MD_DigitalTransferOption.onLine > CI_OnlineResource	O

- a) the Profile imposes a mandatory obligation on the metadata element *fileIdentifier*
- b) language: documented if not defined by the encoding process
- c) characterSet: documented if ISO 10646-1, is not used and not defined by the encoding process
- d) documented if a higher level of hierarchy level exists (e.g. if the geographic 'dataset' is part of a 'series')
- e) distance is preferred over *equivalentScale* because the scale will change when presented at different sizes on a screen
- f) characterSet: documented if ISO 10646-1 is not used
- g) include either the geographic bounding box (extents) or the geographic description (It is recommended that geographic bounding box should be used - see Section 5.6.3)
- h) if any one of west longitude, east longitude, south latitude or north latitude exists, then the remaining three must also be completed

Source: Adapted from Table 3 - *Core metadata for geographic datasets* (ISO 19115:2005).

## 4a-5.6 Variations and preferences

### 4a-5.6.1 Metadata element *fileIdentifier*

The obligation for the metadata element *fileIdentifier* is 'optional' in ISO 19115:2005, however this profile applies a more stringent obligation and defines an extension to make the obligation '**mandatory**'. Each product specification will provide rules for creating file identifiers.

For example, this could support linkage between parent and child metadata records. The content of the child's *parentIdentifier* element is the same as the content of the parent's *fileIdentifier* element, thus supporting the hierarchical relationship between metadata records.

#### 4a-5.6.2 Metadata element *parentIdentifier*

The metadata element *parentIdentifier* (conditional obligation) is included as a core metadata element for describing geographic datasets in the profile. Under certain conditions this metadata element is mandatory. For instance, in some cases dataset metadata may be part of a dataset series. In these circumstances *parentIdentifier* shall be populated.

The concept of metadata hierarchies allows a dataset to be described in more than one metadata record. A dataset may be part of a collection, and in this instance, the dataset may be described in two metadata records: as a dataset in its own right and as part of a collection. The dataset may also be more discrete. For example, a chart may be described individually and as part of a collection or (chart series). An organization may choose to produce a metadata record for each chart and a metadata record for the collection (chart series). Further information on metadata hierarchies and their implementation is available in Annex H and Annex I of ISO 19115.

#### 4a-5.6.3 Geographic extent of the dataset

The ISO 19115:2005 condition for spatial extent determines that if the *hierarchyLevel* is 'dataset' then either the *geographic bounding box* or the *geographic description* is mandatory. To make spatial searches more effective, it is recommended that the extent be described as a geographic bounding box in preference to a geographic description. Completing only the geographic description code may not satisfy the needs of spatial searches as an extent could be ambiguous (e.g. 'France' could mean the mainland only or it may include all external territories). However, in other circumstances, the geographic descriptions are clearly defined, and can present a more efficient means of description. Therefore, product specifications shall specify how geographic extent of a dataset is described.

#### 4a-5.6.4 Data and Date Time information

Dates for both the metadata and the actual data must be provided. In MD\_Metadata, there is a date stamp for the metadata. In the citation, provided as part of MD\_Identifier, there is a production, publication, or revision date for the dataset. These dates are not necessarily the same. In some cases, one set of metadata may be provided for multiple sets of data, which may have been produced, published or revised at different times. The need for an associated date of origin is not restricted to digital or geographic data. Users who derive results from reprocessed data need to know the version of the data they are using.

This profile constrains the choices available in ISO 19115, which references ISO 19103 and ISO 8601. These classes are documented in full in ISO/TS 19103. Both Date and DateTime, shall follow the basic format for complete specification, as per ISO 8601.

- 1) **Date:** the date format shall be year, month and day and will be encoded as a character string (i.e. CCYYMMDD).
- 2) **DateTime:** shall be a combination of a **date** and a **time** (given by hour, minute and second), with a time zone i.e. CCYYMMDDTHHMMSS±hhmm (or 'Z' for UTC). Note that +0100 implies one hour ahead of UTC, such as might occur in Geneva.
- 3) Where any part of the date is not known then lower precision dates or dateTimes need to be stored as per ISO 8601, e.g. if a date was known to be sometime in 1990 but the exact month and day are not known then the date would be given as 1990.

#### 4a-5.6.5 Metadata extension information

The *S100\_Metadata* class specialises the *MD\_Metadata* class, restricting the obligation of *fileIdentifier* from optional to mandatory. Tables 4a-3 and 4a-4 provide relevant information about the extension for *S100\_Metadata*. A modified UML diagram is provided at Appendix 4a-A, the modified values for the data dictionary are provided at Appendix 4a-B (Table B-1 - *Modifications to data dictionary ISO 19115:2005*).

**Table 4a-3 — Metadata extension for *S100\_Metadata***

MD_MetadataExtensionInformation		
MD_MetadataElementInformation		
name	S100_Metadata	
shortName	S100Meta	
definition	S-100 Metadata Profile of MD_Metadata	
obligation	Mandatory	
condition		
dataType	specifiedClass	
maximumOccurrence	1	
domainValue		
parentEntity	MD_Metadata	
rule	New class	
Rationale	Extension of MD_Metadata to include change of obligation to <i>fileIdentifier</i>	
Source	organisationName	International Hydrographic Organization
	role	owner

**Table 4a-4— Metadata extension for *S100\_Metadata***

MD_MetadataExtensionInformation		
MD_MetadataElementInformation		
name	fileIdentifier	
shortName	mdFileId	
definition	ISO 19115:2005 element (2)	
obligation	mandatory	
condition		
dataType	characterString	
maximumOccurrence	1	
domainValue	free text	
parentEntity	S100_Metadata	
rule	Change obligation to mandatory	
Rationale	To ensure a file identifier is always entered	
Source	organisationName	International Hydrographic Organization
	role	owner

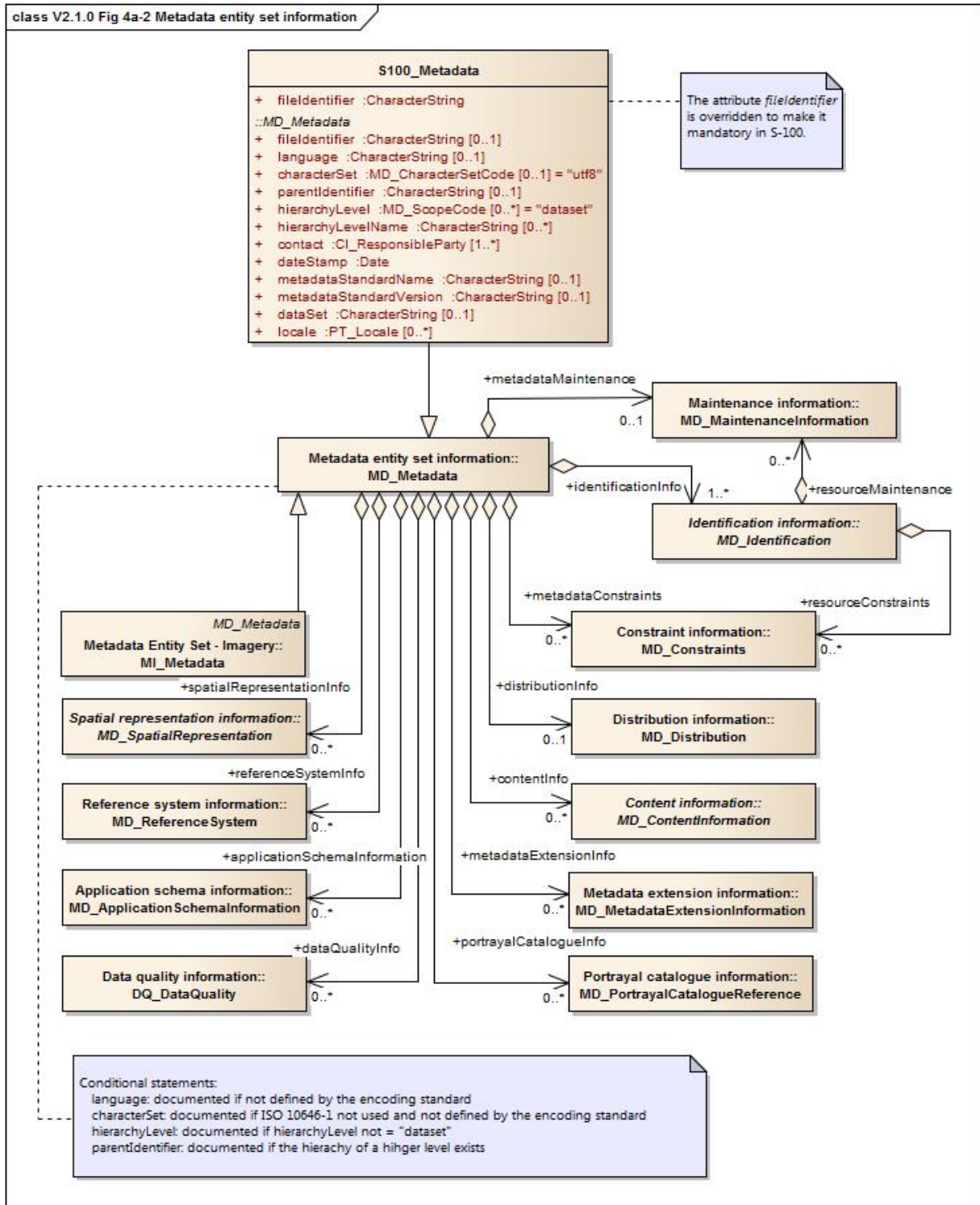
## Appendix 4a-A

### Metadata Entity Set Information

(normative)

The structure of metadata included in the S-100 Metadata Profile is defined with reference to UML diagrams that identify metadata packages and classes included at Annex A of ISO 19115:2005 (and further modified by Technical Corrigendum 1 ISO 19115:2003/Cor.1:2006). [It should be noted that in ISO 19115:2003/Cor.1:2006, there is a discrepancy between the use of “locale” in the UML diagram (Figure A.1) and element 11.2 “locate” in Table B.2.1. The word “locale” in MD\_Metadata shown in Figure 4a-A-1 below is the correct reference].

The new class *S100\_Metadata* shows the relationship to *MD\_Metadata* and its related metadata classes. For the purpose of this Profile *Metadata entity set information* replaces the equivalent diagram Figure A.1 in ISO 19115:2005.



Source: Adapted from ISO 19115:2005 and ISO 19115:2003/Cor.1:2006

Figure 4a-A-1— Metadata entity set information

## Appendix 4a-B Data Dictionary (normative)

The data dictionary in Annex B of ISO 19115:2005 (and further modified by ISO 19115:2003/Cor.1:2006) describes the characteristics of the metadata identified in the UML package diagrams included at Annex A of 19115.

Modifications to the data dictionary, required to recognise the extension to the metadata element *fileIdentifier* that was introduced in this Profile, are included at Table 4a-B-1. The information contained in the table replaces, or is in addition to, that provided at B.2.1, Annex B, ISO 19115:2005 and ISO 19115:2003/Cor.1:2006.

**Table 4a-B-1 — Modifications to the data dictionary ISO 19115:2005**

	Name / Role name	Short Name	Definition	Ob	Max Occ	Data type	Comment
1	MD_Metad a	Metadata	root entity which defines metadata about a resource or resources	M	1	Class	See B.2.1, Annex B, ISO 19115:2005
1. 1	S100_Metad ata	S100Meta	root entity which defines metadata about a resource or resources	M	1	Class	Specialises <i>MD_Metadata</i> class
2	fileIdentifier	mdFileID	unique identifier for this metadata file	M	1	Character String	Free text (changed obligation from optional to mandatory)

**Ob** = Obligation / Condition **Max Occ** = Maximum occurrence

## Appendix 4a-C

### Metadata Implementation

(normative)

#### Background

ISO 19115:2005 defines the content of a set of metadata elements, their definitions, data types and inherent dependencies. The logical model of the metadata specifies the content and not the form of implementation or the form of presentation. A primary goal in the management of metadata for resources is the ability to access the metadata and the related resource it describes. This requires software implementations using common encoding methods to achieve operational use of the metadata.

It is necessary to implement the Profile in order to prove compliance. ISO/TS 19139:2007 is an XML schema implementation of ISO 19115:2003 and can be used to prove partial compliance to ISO 19115:2003 and the S-100 metadata profile. IHO has developed additional Schematron rules to enforce the additional restriction for the fileIdentifier element. Proof of compliance to this profile is via validation of the XML document instances against the ISO/TS 19139:2007 XML Schema Definition (XSDs) and the S-100 Schematron Metadata Rules.

While the S100\_Metadata class specializes the MD\_Metadata class, the specialization only involves restricting fileIdentifier from optional to mandatory. Therefore the MD\_Metadata root element must be used instead of the S100\_Metadata for XML instances of S-100 metadata in order to ensure interoperability with ISO standards and software tool.

Granularity of geographic data supported: The notion of cataloguing a set of related documents together in a discoverable series is common practice for map catalogues. With digital spatial data, the definition of what constitutes a dataset is more problematic and reflects the institutional and software environments of the originating organisation. Common metadata can be derived for a series of related geographic datasets, and such metadata is generally relevant or can be inherited by each of the dataset instances. Software to support this inheritance of metadata for geographic data within a cataloguing system can simplify data entry, update and reporting.

There is a potential hierarchy of reusable metadata that can be employed in implementing a metadata collection. By creating several levels of abstraction, a linked hierarchy can assist in filtering or targeting user queries to the requested level of detail. The hierarchy should not necessarily be interpreted to require multiple copies of metadata being managed online. Conversely, the definition of general metadata can be supplemented by spatially specific metadata that, when queried, either inherits or overrides the general case.

Through the use of pointers this method can reduce the redundancy of metadata managed at a site and provide for different views of the holdings by users. These 'pointers' are implemented in the XSDs by XLink attributes.

Dependencies between metadata document elements and elements in other metadata documents may exist, allowing inheritance of metadata between hierarchy levels. Dependencies between metadata document elements and resources from standard registers may exist, allowing re-use of standard resources without copying the content. For either purpose the dependency may be made explicit through use of the XLink attributes which are available on most property elements in the XML representation. XLink:href is used to point to the re-used resource. XLink:arcrole is used to indicate the kind of re-use. XLink:role is used to indicate the nature of the reused resource.



## Appendix 4a-D Discovery Metadata for Information Exchange Catalogues (normative)

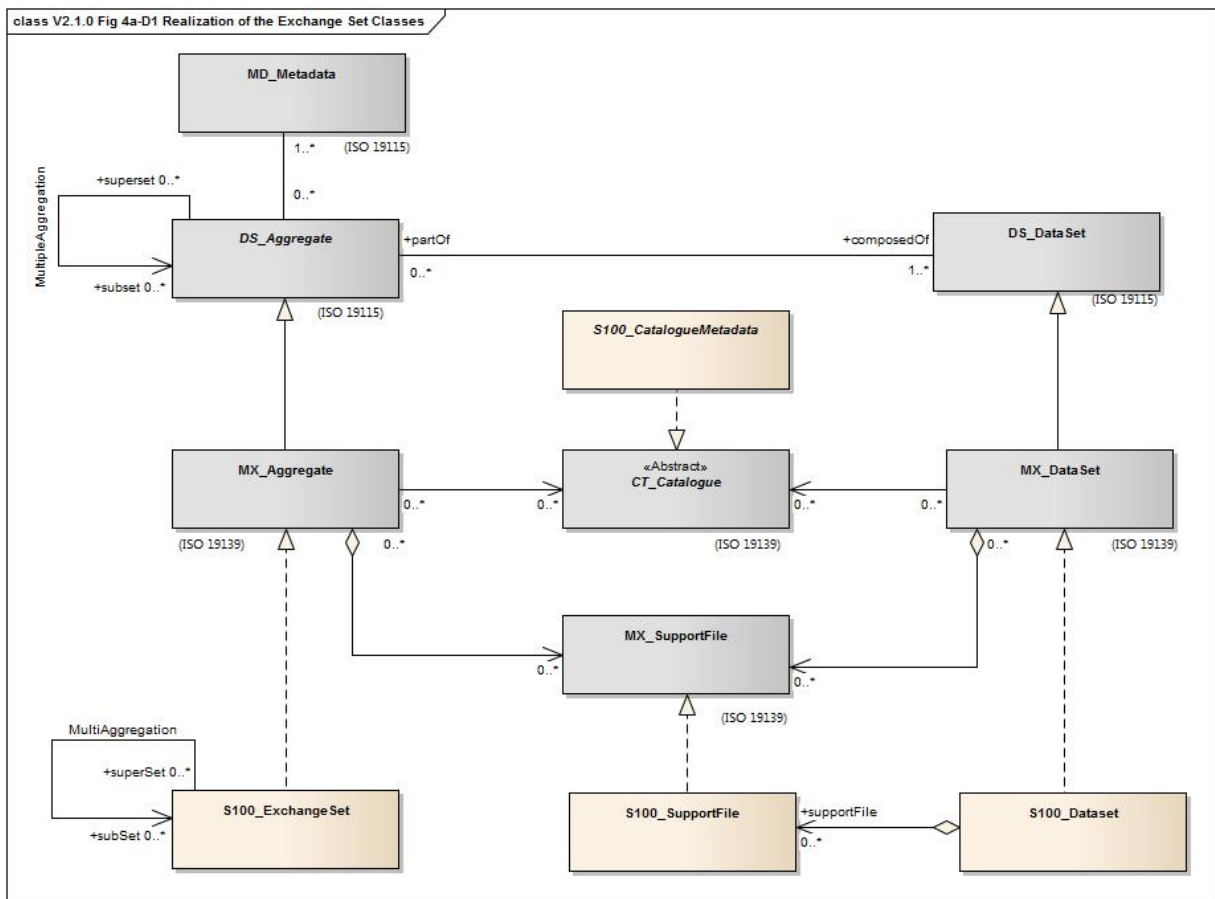
### Introduction

For information exchange, there are several categories of metadata required: metadata about the overall exchange catalogue, metadata about each of the datasets contained in the catalogue, and metadata about the support files that make up the package.

### Overview

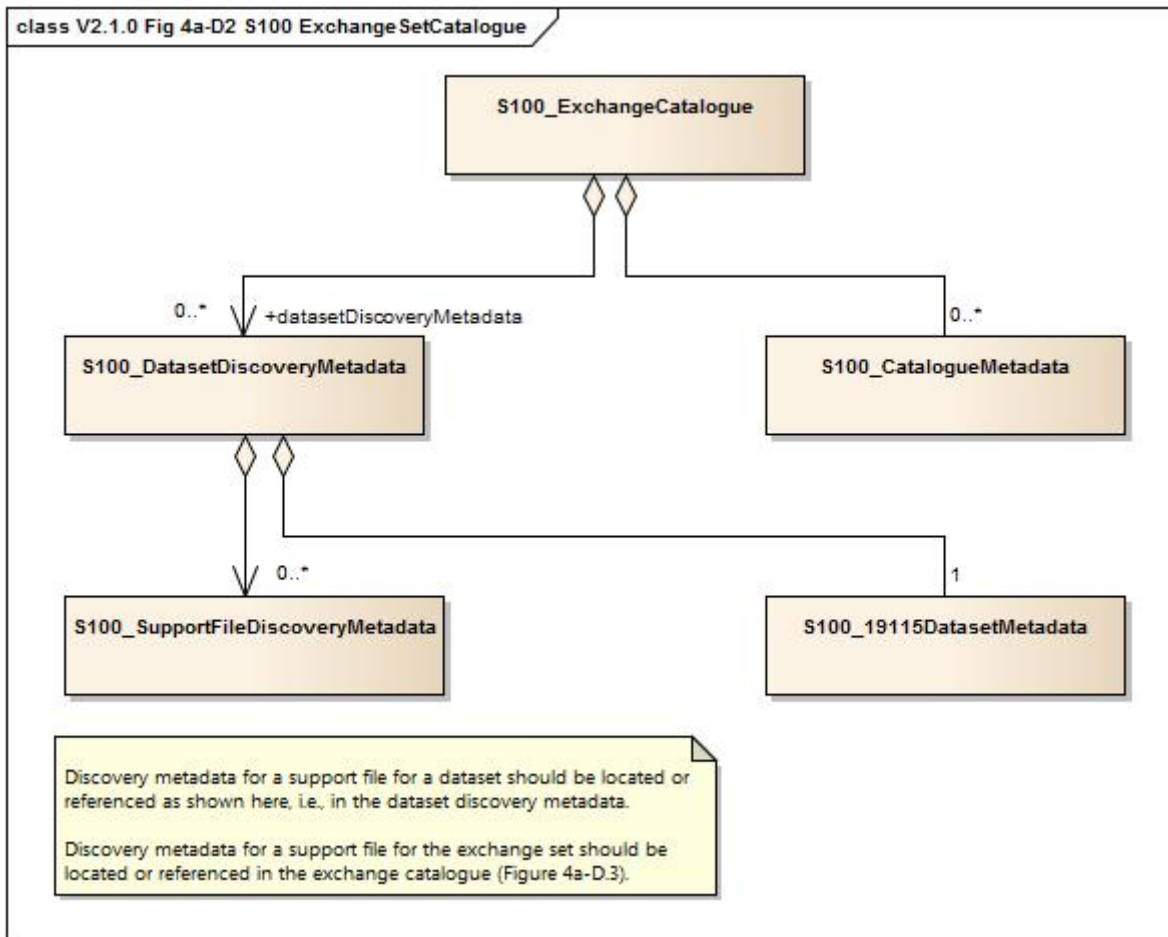
Figures 4a-D-1 to 4a-D-3 outline the overall concept of an S-100 exchange set for the interchange of geospatial data and its relevant metadata. Figure 4a-D-1 depicts the realization of the ISO 19139 classes which form the foundation of the exchange set. The overall structure of S-100 Exchange Sets is modelled in Figure 4a-D-3. More detailed information about the various classes is shown in Figure 4a-D-2 and a textual description in the tables at clause 3.

The discovery metadata classes have numerous attributes which enable important information about the datasets and accompanying support files to be examined without the need to process the data, e.g. decrypt, decompress, load etc. Other catalogues can be included in the exchange set in support of the datasets such as feature, portrayal, coordinate reference systems, codelists etc. The attribute “purpose” of the support file metadata provides a mechanism to update support files more easily.



**Figure 4a-D-1 Realization of the Exchange Set Classes**

The S100\_ExchangeCatalogue is an XML instance, which provides the information needed to exploit all the components of an exchange set. It consists of sections for the catalogues and datasets with subsections for support file metadata and a reference to classic ISO 19115 dataset metadata.



**Figure 4a-D-2 – S-100 Exchange Set Catalogue**

The S-100 Exchange set is a container that combines all the elements needed for the exchange of S-100 data. The exchange set may include S-100 based datasets, files, feature catalogues and portrayal catalogues as shown in figure 4a-D-3 below.

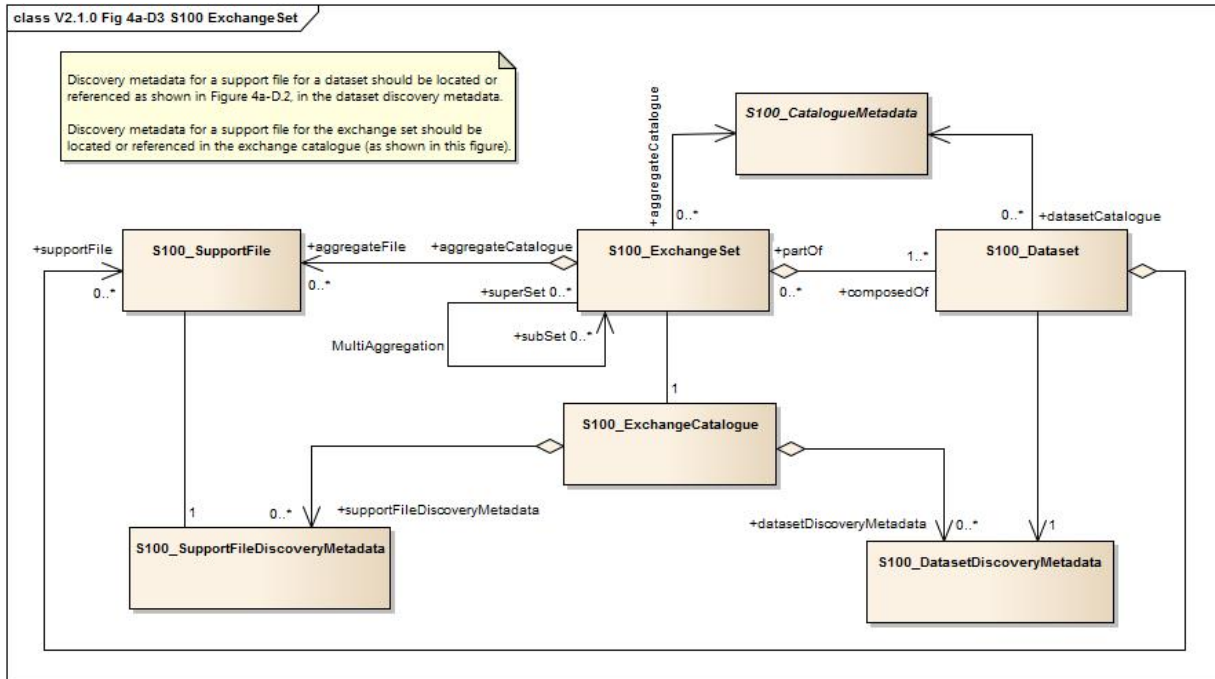


Figure 4a-D-3 – S-100 Exchange Set

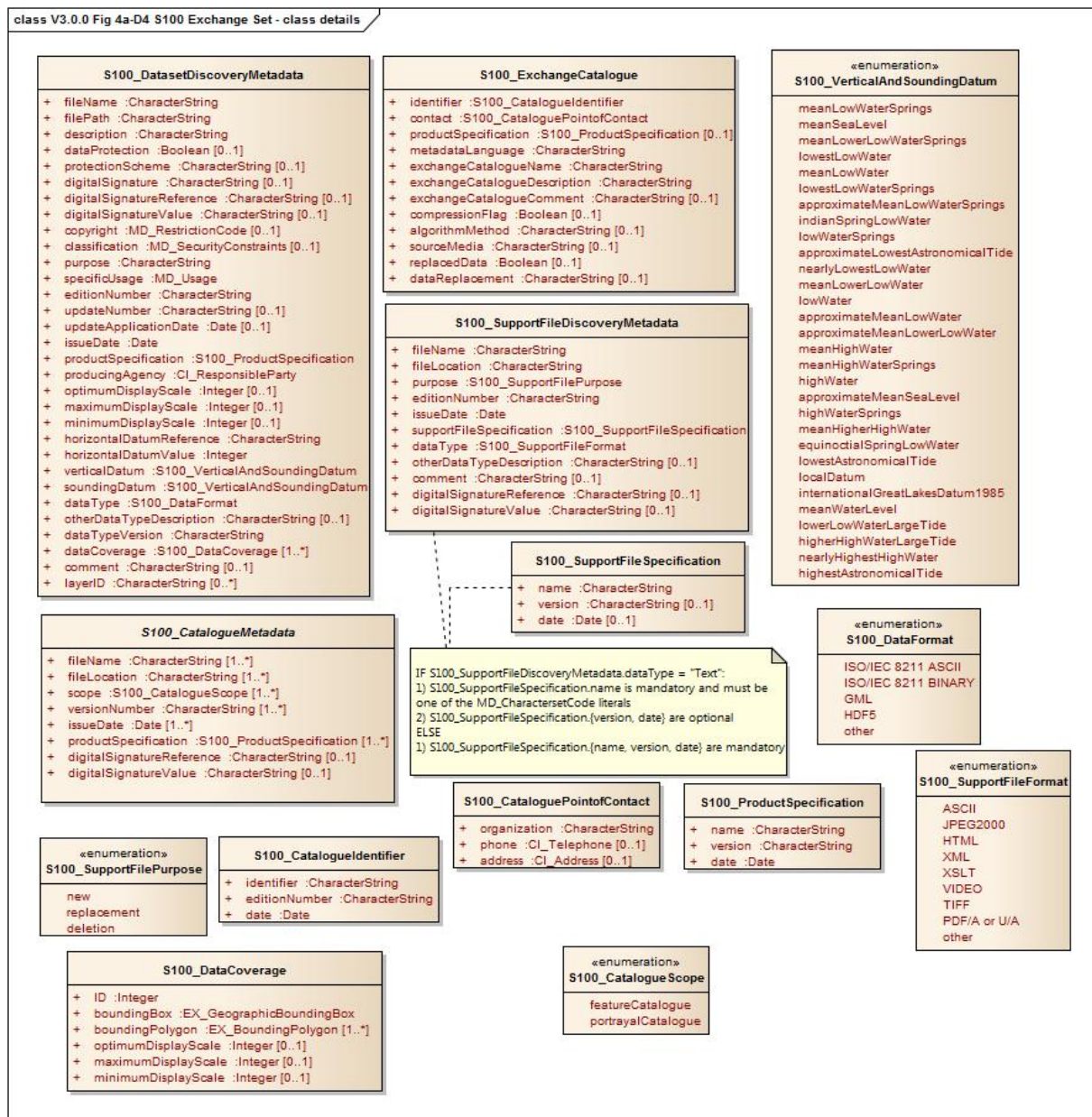


Figure 4a-D-4 S-100 Exchange Set - class details

## Elements of the exchange set

### S100\_ExchangeSet

An S-100 Exchange Set is an aggregation of all the various elements required to support the interchange of geospatial data and metadata. The MultiAggregation association introduces the concept of using subsets which could be domain oriented e.g. packaged by scale, producer, region etc.

Role Name	Name	Description	Mult	Type	Remarks
Class	S100_ExchangeSet	Aggregation of the elements comprising an exchange set for the transfer of data	-	-	-
Role	aggregateFile	Collection of support files in the exchange set	0..*	-	
Role	partOf	Collection of datasets which are part of the exchange set	0..*	-	
Role	aggregateCatalogue	Collection of catalogues	0..*	-	
Role	superSet	The master container exchange set which can contain a subSet of exchange sets			
Role	subSet	Exchange set which is part of the superSet			

### S100\_ExchangeCatalogue

Each exchange set has a single S100\_ExchangeCatalogue which contains meta information for the data and support files in the exchange set.

Role Name	Name	Description	Mult	Type	Remarks
Class	S100_ExchangeCatalogue	An exchange catalogue contains the discovery metadata about the exchange datasets and support files	-	-	-
Attribute	identifier	Uniquely identifies this exchange catalogue	1	S100_CatalogueIdentifier	
Attribute	contact	Details about the issuer of this exchange catalogue	1	S100_CataloguePointOfContact	
Attribute	productSpecification	Details about the product specifications used for the datasets contained in the exchange catalogue	0..1	S100_ProductSpecification	Conditional on all the datasets using the same product specification
Attribute	metadataLanguage	Details about the Language	1	CharacterString	
Attribute	exchangeCatalogueName	Catalogue filename	1	CharacterString	In S-101 it would be CATLOG.101

Attribute	exchangeCatalogueDescription	Description of what the exchange catalogue contains	1	CharacterString	
Attribute	exchangeCatalogueComment	Any additional Information	0..1	CharacterString	
Attribute	compressionFlag	Is the data compressed	0..1	Boolean	Yes or No
Attribute	algorithmMethod	Type of compression algorithm	0..1	CharacterString	Eg. RAR or ZIP
Attribute	sourceMedia	Distribution media	0..1	CharacterString	
Attribute	replacedData	If a data file is cancelled is it replaced by another data file	0..1	Boolean	
Attribute	dataReplacement	Cell name	0..1	CharacterString	

### S100\_CatalogueIdentifier

Role Name	Name	Description	Mult	Type	Remarks
Class	S100_CatalogueIdentifier	An exchange catalogue contains the discovery metadata about the exchange datasets and support files	-	-	-
Attribute	identifier	Uniquely identifies this exchange catalogue	1	CharacterString	
Attribute	editionNumber	The edition number of this exchange catalogue	1	CharacterString	
Attribute	date	Creation date of the exchange catalogue	1	Date	

### S100\_CataloguePointofContact

Role Name	Name	Description	Mult	Type	Remarks
Class	S100_CataloguePointOfContact	Contact details of the issuer of this exchange catalogue	-	-	-
Attribute	organization	The organization distributing this exchange catalogue	1	CharacterString	This could be an individual producer, value added reseller, etc.
Attribute	phone	The phone number of the organization	0..1	CI_Telephone	
Attribute	address	The address of the organization	0..1	CI_Address	

**S100\_Dataset**

Role Name	Name	Description	Mult	Type	Remarks
Class	S100_Dataset		-	-	-
Role	composedOf	An exchange set is composed of 0 or more datasets	0..*	-	
Role	datasetCatalogue	Catalogue which is related to this dataset	0..*	-	

**S100\_DatasetDiscoveryMetaData**

Role Name	Name	Description	Mult	Type	Remarks
Class	S100_DatasetDiscoveryMetadata	Metadata about the individual datasets in the exchange catalogue	-	-	-
Attribute	fileName	Dataset file name	1	CharacterString	
Attribute	filePath	Full path from the exchange set root directory	1	CharacterString	Path relative to the root directory of the exchange set. The location of the file after the exchange set is unpacked into directory <EXCH_ROOT> will be <EXCH_ROOT>/<filePath>/<filename>
Attribute	description	Short description giving the area or location covered by the dataset	1	CharacterString	E.g. a harbour or port name, between two named locations etc.
Attribute	dataProtection	Indicates if the data is encrypted	0..1	Boolean	0 indicates an unencrypted dataset 1 indicates an encrypted dataset
Attribute	protectionScheme	specification or method used for data protection	0..1	CharacterString	Eg S-63
Attribute	digitalSignature	Indicates if the data has a digital signature	0..1	CharacterString	
Attribute	digitalSignatureReference	Digital Signature of the file	0..1	CharacterString	Specifies the algorithm used to compute digitalSignatureValue
Attribute	digitalSignatureValue	Value derived from the digital signature	0..1	CharacterString	The value resulting from application of digitalSignatureReference
Attribute	copyright	Indicates if the dataset is copyrighted	0..1	MD_LegalConstraints >MD_RestrictionCode <copyright> (ISO 19115)	-
Attribute	classification	Indicates the security classification of the dataset	0..1	Class  MD_SecurityConstraints>MD_ClassificationCode (codelist)	1. unclassified  2. restricted  3. confidential

Role Name	Name	Description	Mult	Type	Remarks
					4. secret 5. top secret
Attribute	purpose	The purpose for which the dataset has been issued	1	MD_Identification>purpose CharacterString	E.g. new, re-issue, new edition, update etc.
Attribute	specificUsage	The use for which the dataset is intended	1	MD_USAGE>specificUsage (character string) MD_USAGE>userContactInfo (CI_ResponsibleParty)	E.g. in the case of ENCs this would be a navigation purpose classification.
Attribute	editionNumber	The edition number of the dataset	1	CharacterString	when a data set is initially created, the edition number 1 is assigned to it. The edition number is increased by 1 at each new edition. Edition number remains the same for a re-issue.
Attribute	updateNumber	Update number assigned to the dataset and increased by one for each subsequent update	0..1	CharacterString	Update number 0 is assigned to a new dataset.
Attribute	updateApplicationDate	this date is only used for the base cell files (i.e. new data sets, re-issue and new edition), not update cell files. All updates dated on or before this date must have been applied by the producer	0..1	Date	
Attribute	issueDate	date on which the data was made available by the data producer	1	Date	
Attribute	productSpecification	The product specification used to create this dataset	1	S100_ProductSpecification	
Attribute	producingAgency	Agency responsible for producing the data	1	CI_ResponsibleParty	
Attribute	optimumDisplayScale	The scale with which the data is optimally displayed	0..1	Integer	Example: A scale of 1:25000 is encoded as 25000
Attribute	maximumDisplayScale	The maximum scale with which the data is displayed	0..1	Integer	
Attribute	minimumDisplayScale	The minimum scale with which the data is displayed	0..1	Integer	
Attribute	horizontalDatumReference	Reference to the register from which the horizontal datum value is taken	1	characterString	EPSG
Attribute	horizontalDatumValue	Horizontal Datum of the entire dataset	1	Integer	4326
Attribute	verticalDatum	Vertical Datum of the entire dataset	1	S100_VerticalAndSoundingDatum	
Attribute	soundingDatum	Sounding Datum of the entire dataset	1	S100_VerticalAndSoundingDatum	



Role Name	Name	Description	Mult	Type	Remarks
				um	
Attribute	dataType	The encoding format of the dataset	1	S100_DataFormat	
Attribute	otherDataTypeDescription	Encoding format other than those listed.	0..1	CharacterString	
Attribute	dataTypeVersion	The version number of the dataType.	1	CharacterString	
Attribute	dataCoverage	Provides information about data coverages within the dataset	1..*	S100_DataCoverage	
Attribute	comment	any additional information	0..1	CharacterString	
Attribute	layerID	Identifies other layers with which this dataset is intended to be used or portrayed	0..*	CharacterString	For example, a marine protected area dataset needs an ENC dataset to portray as intended in an ECDIS

### S100\_DataCoverage

Role Name	Name	Description	Mult	Type	Remarks
Class	S100_DataCoverage		-	-	-
Attribute	ID	Uniquely identifies the coverage	1	Integer	-
Attribute	boundingBox	The extent of the dataset limits	1	EX_GeographicBoundingBox	-
Attribute	boundingPolygon	A polygon which defines the actual data limit	1..*	EX_BoundingPolygon	-
Attribute	optimumDisplayScale	The scale with which the data is optimally displayed	0..1	Integer	Example: A scale of 1:25000 is encoded as 25000
Attribute	maximumDisplayScale	The maximum scale with which the data is displayed	0..1	Integer	
Attribute	minimumDisplayScale	The minimum scale with which the data is displayed	0..1	Integer	

**S100\_VerticalAndSoundingDatum**

Role Name	Name	Description	Mult	Type	Remarks
Class	S100_VerticalAndSoundingDatum	Allowable vertical and sounding datums	-	-	-
Value	meanLowWaterSprings		-	-	-
Value	meanSeaLevel		-	-	-
Value	meanLowerLowWaterSprings		-	-	-
Value	lowestLowWater		-	-	-
Value	meanLowWater		-	-	-
Value	lowestLowWaterSprings		-	-	-
Value	approximateMeanLowWaterSprings		-	-	-
Value	indianSpringLowWater		-	-	-
Value	lowWaterSprings		-	-	-
Value	approximateLowestAstronomicalTide		-	-	-
Value	nearlyLowestLowWater		-	-	-
Value	meanLowerLowWater		-	-	-
Value	lowWater		-	-	-
Value	approximateMeanLowWater		-	-	-
Value	approximateMeanLowerLowWater		-	-	-
Value	meanHighWater		-	-	-
Value	meanHighWaterSprings		-	-	-
Value	highWater		-	-	-
Value	approximateMeanSeaLevel		-	-	-
Value	highWaterSprings		-	-	-
Value	meanHigherHighWater		-	-	-
Value	equinoctialSpringLowWater		-	-	-
Value	lowestAstronomicalTide		-	-	-

Value	localDatum		-	-	-
Value	internationalGreatLakesDatum1985		-	-	-
Value	meanWaterLevel		-	-	-
Value	lowerLowWaterLargeTide		-	-	-
Value	higherHighWaterLargeTide		-	-	-
Value	nearlyHighestHighWater		-	-	-
Value	highestAstronomicalTide		-	-	(HAT)

### S100\_DataFormat

Role Name	Name	Description	Mult	Type	Remarks
Class	S100_DataFormat	The encoding format	-	-	-
Value	ISO/IEC 8211 ASCII		-	-	-
Value	ISO/IEC 8211 BINARY		-	-	-
Value	GML		-	-	-
Value	HDF5		-	-	-
Value	Other		-	-	-

### S100\_ProductSpecification

Role Name	Name	Description	Mult	Type	Remarks
Class	S100_ProductSpecification	The Product Specification contains the information needed to build the specified product	-	-	-
Attribute	name	The name of the product specification used to create the datasets	1	CharacterString	
Attribute	version	The version number of the product specification	1	CharacterString	
Attribute	date	The version date of the product specification	1	Date	

**S100\_SupportFile**

Role Name	Name	Description	Mult	Type	Remarks
Class	S100_SupportFile		-	-	-
Role	aggregateFile	Collection of support files	0..*	-	
Role	supportFile	File which has information about a dataset	0..*	-	

**S100\_SupportFileDiscoveryMetadata**

Role Name	Name	Description	Mult	Type	Remarks
Class	S100_SupportFileDiscoveryMetadata	Metadata about the individual support files in the exchange catalogue	-	-	-
Attribute	fileName	Name of the support file	1	CharacterString	
Attribute	fileLocation	Full location from the exchange set root directory	1	CharacterString	Path relative to the root directory of the exchange set. The location of the file after the exchange set is unpacked into directory <EXCH_ROOT> will be <EXCH_ROOT>/<filePath>/<filename>
Attribute	purpose	The purpose for which the dataset has been issued	1	S100_SupportFilePurpose	E.g. new, re-issue, new edition, update etc.
Attribute	editionNumber	The edition number of the dataset	1	CharacterString	when a data set is initially created, the edition number 1 is assigned to it. The edition number is increased by 1 at each new edition. Edition number remains the same for a re-issue.
Attribute	issueDate	date on which the data was made available by the data producer	1	Date	
Attribute	productSpecification	The product specification used to create this file	1	S100_ProductSpecification	
Attribute	dataType	The encoding format of the dataset	1	S100_SupportFileFormat	
Attribute	otherDataTypeDescription	Encoding format other than those listed.	0..1	CharacterString	
Attribute	dataTypeVersion	The version number of the dataType.	1	CharacterString	
Attribute	comment		0..1	CharacterString	
Attribute	digitalSignatureReference	Digital Signature of the file	0..1	CharacterString	Reference to the appropriate digital signature algorithm
Attribute	digitalSignatureValue	Value derived from the digital signature	0..1	CharacterString	

**S100\_SupportFileFormat**

Role Name	Name	Description	Mult	Type	Remarks
Class	S100_SupportFormat	The format used in the support file	-	-	-
Value	ASCII		-	-	
Value	JPEG2000		-	-	
Value	HTML		-	-	
Value	XML		-	-	
Value	XSLT		-	-	
Value	VIDEO		-	-	
Value	TIFF				
Value	PDF/A or UA				Product Specification developers should take careful consideration in using PDF as a support file format. It is recommended that PDF never be used in products that will be used on a navigation system as it may impair night vision.
Value	Other		-	-	

**S100\_SupportFilePurpose**

Role Name	Name	Description	Mult	Type	Remarks
Class	S100_SupportFilePurpose	The reason for inclusion of the support file in this exchange set	-	-	-
Value	new	A file which is new	-	-	Signifies a new file.
Value	replacement	A file which replaces an existing file	-	-	Signifies a replacement for a file of the same name
Value	deletion	Deletes an existing file	-	-	Signifies deletion of a file of that name

**S100\_CatalogueMetadata**

Role Name	Name	Description	Mult	Type	Remarks
Class	S100_Catalogue		-	-	-

Attribute	filename	The name for the catalogue	1..*	CharacterString	
Attribute	fileLocation	Full location from the exchange set root director	1..*	CharacterString	Path relative to the root directory of the exchange set. The location of the file after the exchange set is unpacked into directory <EXCH_ROOT> will be <EXCH_ROOT>/<filePath>/<filename>
Attribute	scope	Subject domain of the catalogue	1..*	S100_CatalogueScope	
Attribute	versionNumber	The version number of the product specification	1..*	CharacterString	
Attribute	issueDate	The version date of the product specification	1..*	Date	
Attribute	productSpecification	The product specification used to create this file	1..*	S100_ProductSpecification	
Attribute	digitalSignatureReference	Digital Signature of the file	1	CharacterString	Reference to the appropriate digital signature algorithm
Attribute	digitalSignatureValue	Value derived from the digital signature	1	CharacterString	

### S100\_CatalogueScope

Role Name	Name	Description	Mult	Type	Remarks
Class	S100_CatalogueScope		-	-	-
Value	featureCatalogue				
Value	portrayalCatalogue				

# **S-100 – Part 4b**

## **Metadata for Imagery and Gridded Data**

## Contents

4b-1	Scope .....	1
4b-2	Normative references .....	1
4b-3	Imagery and gridded data metadata .....	2
4b-3.1	Associated ISO standards.....	2
4b-3.2	Metadata packages .....	2
4b-3.2.1	Metadata Entity Set for Imagery.....	4
4b-3.2.2	Data quality information for Imagery .....	4
4b-3.2.3	Spatial representation information for Imagery .....	4
4b-3.2.4	Content information for Imagery.....	4
4b-3.2.5	Acquisition Information for Imagery.....	5
4b-4	UML diagrams and data dictionary .....	5



## 4b-1 Scope

The general scope of parts 4a, 4b and 4c has been described at the beginning of part 4a. This part concerns itself specifically with the growing requirement to manage large volumes of imagery and gridded data which most hydrographic organizations have in addition to handling the vector data. There are many different imagery and gridded data formats and these types of datasets are often stored on distributed systems leading to problems of data discovery, management and exchange.

The production of imagery and gridded data follows the processes that usually begin with the collection of data, scanning of charts and reference documents, and other sensing methods. These types of datasets are often used for the production of paper charts, Electronic Navigational Charts (ENCs), Raster Navigational Charts, and nautical publications. Their production processes need to be documented in order to maintain quality control over the end products. Furthermore, metadata about the geometry of the measuring process and the properties of the measuring equipment needs to be retained with the raw data in order to support the production and maintenance processes.

ISO 19115 defines the guidelines for describing geographic information and services. Although its model does make some provision for imagery and gridded data, these requirements were not fully developed at the time of initial publication in 2003. This metadata part of S-100 is based on ISO 19115 Part 2:2008 which was produced to provide the additional structure to more extensively describe the derivation of geographic imagery and gridded data, and it is intended to augment ISO 19115.

## 4b-2 Normative references

The following referenced documents are indispensable for the application of this document. For dated references, only the edition cited applies. For undated references, the latest edition of the referenced document (including any amendments) applies.

ISO/TS 19103, Geographic information — Conceptual schema language

ISO 19107:2003, Geographic information — Spatial schema

ISO 19115:2005, Geographic information — Metadata

ISO 19115-2:2008 Geographic information – Metadata – Part 2: Extensions for imagery and gridded data

ISO/TS 19139 Geographic information — Metadata — XML schema implementation

ISO 19119:2005 Geographic information -- Services

IHO S-61 Product Specification for Raster Navigational Charts

## **4b-3 Imagery and gridded data metadata**

ISO 19115 identifies the metadata required to describe digital geographic data, and the extensions described in this section identify the metadata required to describe digital geospatial imagery and gridded data. Digital geospatial imagery and gridded metadata may also be provided for aggregations of datasets.

### **4b-3.1 Associated ISO standards**

ISO 19115 is designed to be the general metadata standard applicable to all geographic data sets. It identifies a set of core metadata derived from the many metadata elements and also specifies the conditions under which they should be used (i.e. mandatory, conditional, or optional). Although there is some service metadata in ISO 19115, (particularly in the area of identification), much of the service metadata is defined in ISO 19119 (Services). ISO 19115 makes provision for limited metadata describing spatial and temporal schemas.

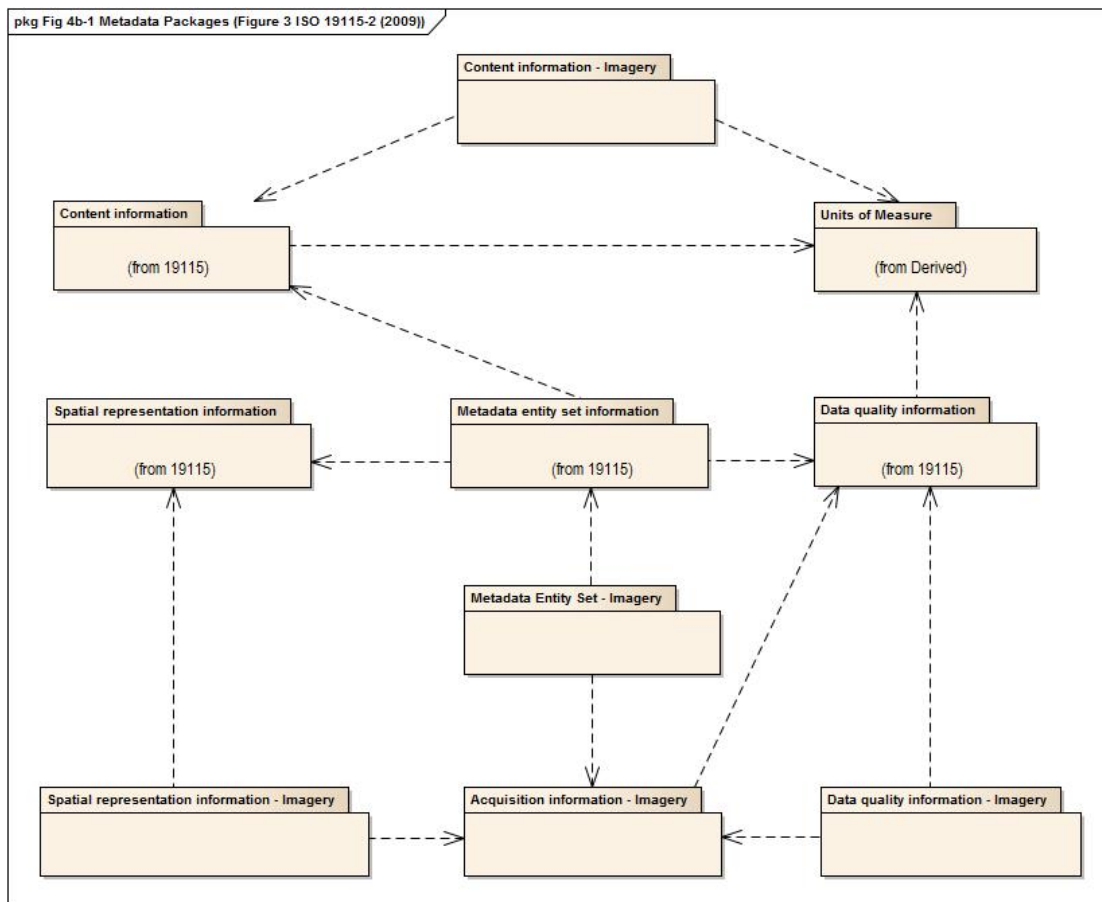
ISO 19115 - Part 2 extends the metadata defined in ISO 19115 and identifies additional metadata (such as data quality, spatial representation, content, and acquisition information), required to describe imagery and gridded data. It provides information about the properties of the measuring equipment used to acquire data, geometry of the measuring processes employed by the equipment, and production processes used to digitize the raw data.

Geolocation information is a very important metadata component required for imagery. ISO 19115 and 19115 - Part 2 may not include sufficient geolocation metadata for imagery and gridded data. It may therefore be necessary to reference ISO 19130. This standard specifies additional information required to support geolocation and also defines how sensor measurements and geolocation information are logically associated. The georeferencing information in ISO 19130 is a subset of that described in ISO 19115-Part 2. In order to develop a full set of imagery metadata, it may be necessary to combine the relevant sections from ISO 19115 and 19115 - Part 2, with the geolocation information or sensor properties from ISO 19130.

ISO 19139 - XML schema implementation, expands ISO 19115 by defining new constraint types that further refine the metadata elements for implementation. It also defines the rules used for deriving an XML schema from the ISO abstract UML models.

### **4b-3.2 Metadata packages**

The relationships between the packages contained in ISO 19115 and the extensions for geospatial imagery and gridded data are illustrated in Figure 4b-1 below. These metadata extensions have been fully documented using both UML models and a data dictionary, in ISO/TC211 19115 – Part 2 - Annex A and Annex B respectively.



**Figure 4b-1 — Metadata packages**

It should also be noted that, to ensure global uniqueness, ISO/TS 19103 requires that all class names must be defined by a bi-alpha prefix that identifies the package to which a class belongs. ISO 19115 uses the prefixes MD (Metadata), CI (Citation), DQ (Data quality), EX (Extent), and LI (Lineage). To differentiate between entities used in ISO 19115 and those used in ISO 19115-Part 2 (Extensions for imagery and gridded data), the MI prefix is used for imagery and gridded metadata, and LE and QE are used for extended Lineage and Data quality entities respectively. Table 4b-1 contains the list of package identifiers for the classes used for metadata.

**Table 4b-1 —UML Package Identifiers**

Identifier	Information Type	Standard
MD	Metadata	ISO 19115
MI	Metadata for Imagery	ISO 19115-2
DQ	Data Quality	ISO 19115
QE	Data quality Extended	ISO 19115-2
CI	Citation	ISO 19115
LI	Lineage	ISO 19115
LE	Lineage Extended for Imagery	ISO 19115-2
EX	Extent	ISO 19115
GM	Geometry	ISO 19107
MX	Metadata – XML schema	ISO/TS 19139

#### 4b-3.2.1 Metadata Entity Set for Imagery

MI\_Metadata is a subclass of MD\_Metadata which aggregates the optional entity MI\_AcquisitionInformation. See sections A.2.1 and B.2.1 of 19115-Part 2 for additional descriptive information and the data dictionary respectively.

#### 4b-3.2.2 Data quality information for Imagery

Information about the sources and production processes used in producing an imagery or gridded dataset has been included in an additional Data Quality for Imagery package, as 19115 only makes provision for a general assessment of the quality. The following additional classes are listed below. A more detailed description of the classes and associated data dictionary are provided in 19115-Part 2, sections A.2.2 and B.2.2 respectively).

- 1) QE\_CoverageResult is a specified subclass of DQ\_Result and aggregates information required to report data quality for a coverage. It is based on concepts from 19115 and 19139.
- 2) QE\_Usability is a specified subclass of DQ\_Element. It is intended to provide user specific
- 3) quality information about a dataset's suitability for a particular application;
- 4) LE\_ProcessStep is a specified subclass of LI\_ProcessStep and contains additional information on the history of the algorithms used and processing performed to produce the data. LE\_ProcessStep aggregates the following entities;
  - a) LE\_Processing, describes the procedure (such as software used, parameters, and processing documentation) by which the algorithm was applied to generate the data from the source data. LE\_Processing aggregates LE\_Algorithm, which describes the methodology used to derive the data from the source data;
  - b) LE\_ProcessStepReport identifies external information describing the processing of the data;
  - c) LE\_Source is a specified subclass of LI\_Source and describes the output of a process step.

#### 4b-3.2.3 Spatial representation information for Imagery

This package contains information concerning the mechanisms used to represent spatial information. MI\_GeoreferencingDescription contains addition information used to support georectification of the data and is an aggregation of the following entities:

- 1) MI\_Georectified contains check point information to further specify georectification details of the imagery or gridded data. It aggregates MI\_GCP;
- 2) MI\_Georeferenceable makes provision for the inclusion of additional information that can be used to geolocate the data. It aggregates MI\_GeolocationInformation.

#### 4b-3.2.4 Content information for Imagery

Although this package is part of 19115, the following entities have been included to better cater for imagery and gridded data;

- 1) MI\_Band (subclass of MD\_Band) - defines additional attributes for specifying properties of individual wavelength bands in an imagery and gridded dataset;
- 2) MI\_ImageDescription (subclass of MD\_ImageDescription) used to aggregate MI\_RangeElementDescription;
- 3) MI\_CoverageDescription (subclass of MD\_CoverageDescription) used to aggregate MI\_RangeElementDescription;

- 4) MI\_RangeElementDescription - used to provide range elements used in a coverage dataset.

#### **4b-3.2.5 Acquisition Information for Imagery**

MI\_AcquisitionInformation is an aggregate of the following entities:

- 1) MI\_Instrument (the measuring instruments used to acquire the data);
- 2) MI\_Operation,(the overall data gathering program to which the data contribute);
- 3) MI\_Platform (the platform from which the data were taken);
- 4) MI\_Objective,(the characteristics and geometry of the intended object to be observed);
- 5) MI\_Requirement (the user requirements used to derive the acquisition plan);
- 6) MI\_Plan,(the acquisition plan that was implemented to acquire the data).

Two additional classes are required to provide information on the acquisition of the data. These are:

- 1) MI\_Event, describes a significant event that occurred during data acquisition. An event can be associated with an operation, objective, or platform pass, and
- 2) MI\_PlatformPass, identifies a particular pass made by the platform during data acquisition. A platform pass is used to provide supporting identifying information for an event and for data acquisition of a particular objective.

#### **4b-4 UML diagrams and data dictionary**

The metadata schemas for the imagery and gridded data are included in ISO 19115 – Part 2 (Annex A) in the form of UML class diagrams. These diagrams augment the UML diagrams shown in ISO 19115.

ISO 19115 – Part 2, Annex B contains the element and entity definitions for the metadata schemas defined in Annex A. The dictionary, in conjunction with the diagrams presented in Annex A and in combination with the UML diagrams and data dictionary presented in ISO 19115, serves to fully define the total abstract model for metadata.

Enumerations and their values provided in ISO 19115 are normative. User extensions to enumerations shall follow the rules as described in ISO 19115 and Annex C.

# **S-100 – Part 4c**

## **Metadata - Data Quality**

## Contents

4c-1	Scope .....	1
4c-2	References .....	1
4c-3	Content .....	2
4c-3.1	ISO 19138 Quality Measures and UML Classes.....	2
4c-3.2	Core Metadata.....	2
Appendix 4c-A	Hydrographic Quality Metadata profile, UML Diagrams .....	3
Appendix 4c-B	Hydrographic Quality Metadata profile Data Dictionary .....	4
Appendix 4c-C	Hydrographic Quality Metadata Attribute Definitions .....	8

## 4c-1 Scope

The general scope of Parts 4a, b and c has been described at the beginning of Part 4a. This Part is a metadata quality guidance and incorporates quality measures as described in ISO 19113, 19114 and 19138 and complies with ISO 19106 *Geographical Information – Profiles* which describes the rules for developing profiles of the 19100 series standards. This guidance is applicable to IHO hydrographic data sets, data set series, and individual features and feature properties. It is intended for hydrographic requirements and describes how to document information about the quality of digital geographic data.

The purpose of this Part is to:

- 1) Provide data producers with appropriate information to characterize their geographic data properly.
- 2) Enable users to determine whether geographic data in a holding will be of use to them.

It defines:

- 1) Mandatory and conditional metadata sections, metadata entities and metadata elements.
- 2) Optional metadata elements to allow for more detailed description of geographic data.

Although this document is largely based on the standards mentioned above, additional standards are referenced where relevant. (See section 4c-2 References).

## 4c-2 References

The following normative documents contain provisions which, through reference in this text, constitute provisions of this metadata guidance.

ISO 19104, Geographic information – Terminology

ISO 19106, Geographic information — Profiles

ISO 19107, Geographic information — Spatial schema

ISO 19108, Geographic information — Temporal schema

ISO 19115:2003, Geographic information — Metadata

ISO 19113, Geographic information — Quality principles

ISO 19114, Geographic information — Quality evaluation procedures

ISO 19138, Geographic information – Quality measures

ISO 19139 Geographic information – Metadata – XML schema implementation (Preliminary Draft Technical Specification).

ISO 639, Code for the representation of names of languages

ISO 3166-1, Codes for the representation of names of countries and their subdivisions -- Part 1: Country codes

ISO 8601:2000, Data elements and interchange formats -- Information interchange -- Representation of dates and times

ISO 639-1:2002, Codes for the representation of names of languages - Part 1: Alpha-2 code

ISO 639-2:1998, Codes for the representation of names of languages -- Part 2: Alpha-3 code



## **4c-3 Content**

ISO 19115 defines almost 300 metadata elements, which include a group of core metadata elements. S-100 Part 4c (Metadata) describes in general how these are used within S-100. However, to fully describe hydrographic data additional elements are needed. This document describes elements for quality measures as defined and described in ISO 19138.

### **4c-3.1 ISO 19138 Quality Measures and UML Classes**

The IHO Quality Metadata Guidance contains optional quality metadata elements for hydrographic requirements. Additional 19115 elements are available for use; however they may not be recognised by systems not conforming to this profile. The metadata packages used in this profile are shown in Unified Modeling Language (UML) class diagrams at Appendix 4c-A.

S-100 Quality Measure class structure is derived from ISO 19115 Geographic Information Metadata. The attributes described in the S-100 Quality classes each correspond to independent quality measures. Full descriptions of these measures are contained in ISO 19138 Geographic Information Data Quality Measures.

All of the S-100 Quality measures are intentionally optional so that different measures may be used for different types of data. Where multiple attributes describe the same measure in different ways, either only one measure should be used or the measures must be described in a consistent manner.

Additional quality measures may be described in a register of quality measures as described in ISO 19138 Annex B.

### **4c-3.2 Core Metadata**

Core metadata elements are described in S-100 Part 4a: Dataset and feature quality metadata can be linked to a higher hierarchy level field, and all these levels may be supplied in one file or separate metadata files.

## Appendix 4c-A Hydrographic Quality Metadata profile, UML Diagrams (informative)

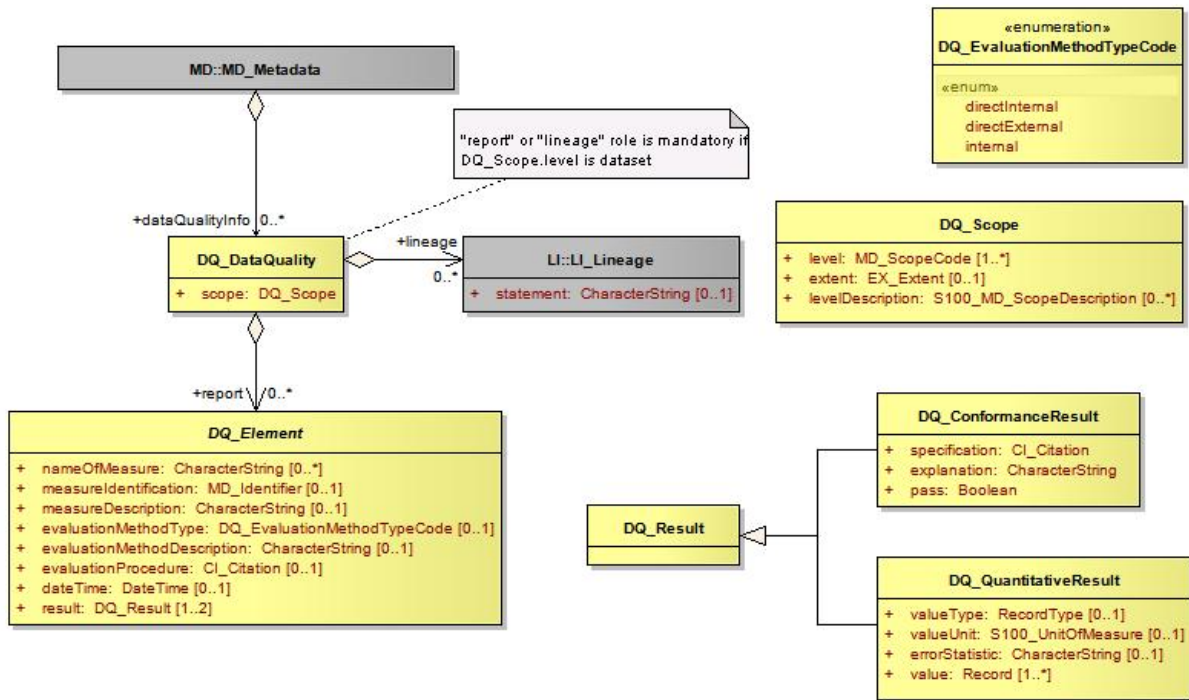


Figure 4c-A-1— Data Quality UML (from ISO 19115)

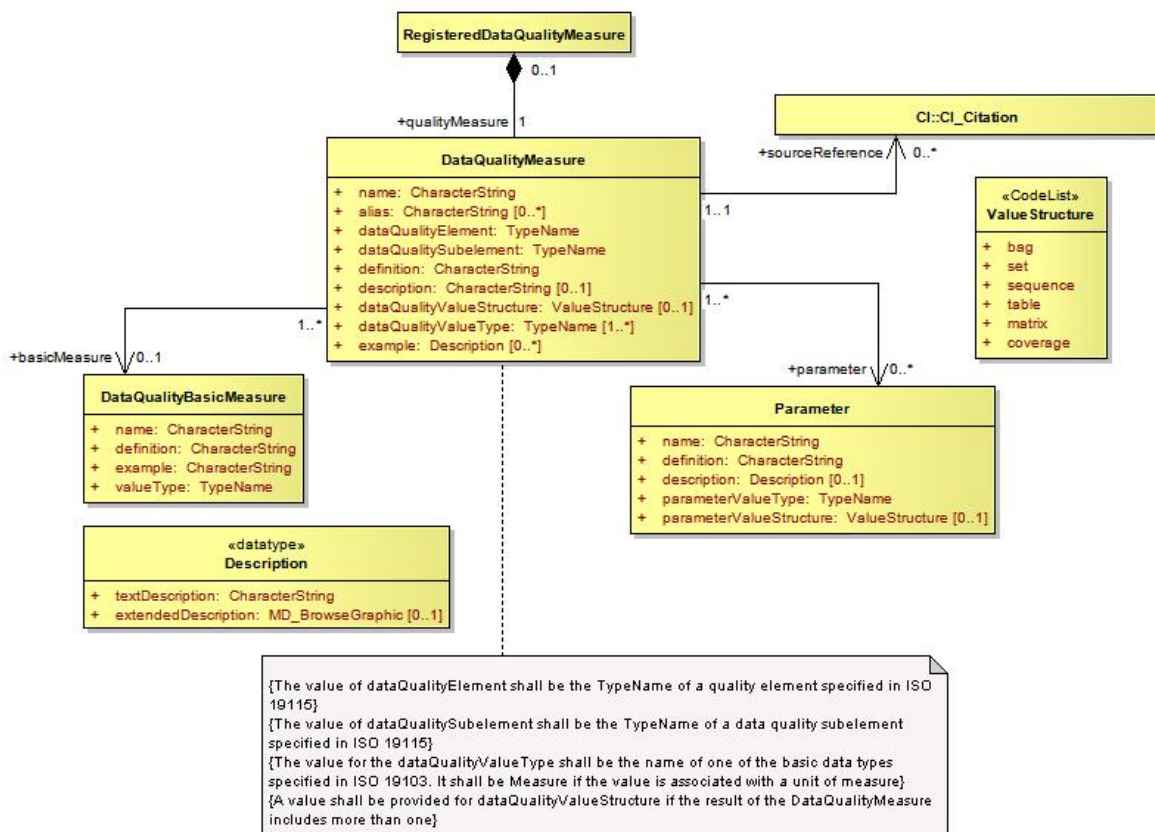


Figure 4c-A-2 — Data Quality Measure Registry UML (from ISO 19138)

## Appendix 4c-B

# Hydrographic Quality Metadata profile Data Dictionary

(normative)

The hydrographic metadata catalogue table below has been derived from the ISO 19115 Standard [1].

The table contains the following information;

- 1) The first column "*ISO LineNo.*" refers to the line numbers in the ISO 19115 Standard, however as this profile does not use all the 19115 elements, line numbers may not always be contiguous.
- 2) Name/role name is a label assigned to a metadata entity or to a metadata element. Further columns could give the name or meaning in other languages.
- 3) Definition column provides a description of the metadata entity/element.
- 4) The obligation descriptor provides an indication of whether a metadata entity or metadata element shall always be documented or will only sometimes be documented. This descriptor may have the following values: M (mandatory), C (conditional), or O (optional).
- 5) The Occurrence column specifies the maximum number of instances the metadata entity or the metadata element may have. Single occurrences are shown by "1"; repeating occurrences are represented by "N". Fixed number occurrences other than one are allowed, and will be represented by the corresponding number (i.e. "2", "3"...etc).
- 6) Data type specifies a set of distinct values for representing the metadata elements; for example, integer, real, string, DateTime, and Boolean. The data type attribute is also used to define metadata entities, stereotypes, and metadata associations.
- 7) Domain - for an entity, the domain indicates the line numbers covered by that entity.

ISO Line No.	Name / role name	Definition	Obligation	Maximum Occurrence	Data Type	Domain
	<b>B.2.4 Data quality information</b>					
	<b>B.2.4.1 General</b>					
78	DQ_DataQuality	quality information for the data specified by a data quality scope	Use obligation from referencing object	Use maximum occurrence from referencing object	Aggregated Class (MD_Metadata)	Lines 79-81
79	scope	the specific data to which the data quality information applies	M	1	Class	DQ_Scope <<DataType>> (B.2.4.4)
80	Role name: report	quantitative quality information for the data specified by the scope	C / lineage not provided?	N	Association	DQ_Element <<Abstract>> (B 2.4.2)
81	Role name: lineage	non-quantitative quality information about the lineage of the data specified by the scope	C / report not provided?	1	Association	LI_Lineage (B 2.4.1)
	<b>B.2.4.2 Lineage information</b>					
	<b>B.2.4.2.1 General</b>					
82	LI_Lineage	information about the events or source data used in constructing the data specified by the scope or lack of knowledge about lineage	Use obligation from referencing object	Use maximum occurrence from referencing object	Aggregated Class (DQ_DataQuality)	Lines 83-85
83	statement	general explanation of the data producer's knowledge about the lineage of a dataset	C / (DQ_DataQuality.scope.DQ_Scope.level = "dataset" or "series")?	1	CharacterString	Free text
84	Role name: processStep	information about an event in the creation process for the data specified by the scope	C / mandatory if statement and source not provided?	N	Association	LI_ProcessStep (B.2.4.1.1)
85	Role name: source	information about the source data used in creating the data specified by the scope	C / mandatory if statement and processStep not provided?	N	Association	LI_Source (B.2.4.1.2)

ISO Line No.	Name / role name	Definition	Obligation	Maximum Occurrence	Data Type	Domain
	<b>B.2.4.2.2 Process step information</b>					
86	LI_ProcessStep	information about an event in the creation process for the data specified by the scope	Use obligation from referencing object	Use maximum occurrence from referencing object	Aggregated Class (LI_Lineage)	Lines 86-91
87	description	description of the event, including related parameters or tolerances	M	1	CharacterString	Free Text
88	rationale	requirement or purpose for the process step	O	1	CharacterString	Free Text
89	dateTime	date and time or range of date and time on or over which the process step occurred	O	1	Class	DateTime (B.4.2)
90	processor	identification of, and means of communication with, person(s) and organisation(s) associated with the process step	O	N	Class	CI_ResponsibleParty <<DataType>> (B.3.2)
91	Role name: source	information about the source data used in creating the data specified by the scope	O	N	Association	LI_Source (B.2.4.1.2)
	<b>B.2.4.2.3 Source information</b>					
92	LI_Source	information about the source data used in creating the data specified by the scope	Use obligation from referencing object	Use maximum occurrence from referencing object	Aggregated Class (LI_Lineage)	Lines 93-98
93	description	detailed description of the level of the source data	C/ sourceExtent not provided?	1	CharacterString	Free Text
94	scaleDenominator	denominator of the representative fraction on a source map	O	1	Class	MD_RepresentativeFraction <<DataType>> (B.2.2.3)
95	sourceReferenceSystem	spatial reference system used by the source data	O	1	Class	MD_ReferenceSystem (B.2.7)
96	sourceCitation	recommended reference to be used for the source data	O	1	Class	CI_Citation <<DataType>> (B.3.2)

ISO Line No.	Name / role name	Definition	Obligation	Maximum Occurrence	Data Type	Domain
97	sourceExtent	information about the spatial, vertical and temporal extent of the source data	C/ description not provided?	N	Class	EX_Extent <<DataType>> (B.3.1)
98	Role name: sourceStep	information about an event in the creation process for the source data	O	N	Association	LI_ProcessStep (B.2.4.1.1)
	<b>B.2.4.2 Data quality element information</b>					
99	DQ_Element	type of test applied to the data specified by a data quality scope	Use obligation from referencing object	Use maximum occurrence from referencing object	Aggregated Class	Lines 100-107
100	nameOfMeasure	name of the test applied to the data	O	N	CharacterString	Free text
101	measureIdentification	code identifying a registered standard procedure	O	1	Class (19138 List)	MD_Identifier.IHO_DqMeasure <<DataType>> (B.2.7.2)
102	measureDescription	description of the measure being determined	O	1	CharacterString	Free text
103	evaluationMethodType	type of method used to evaluate quality of the dataset	O	1	Class	DQ_EvaluationMethodTypeCode << Enumeration >> (B.5.6)
104	evaluationMethodDescription	description of the evaluation method	O	1	CharacterString	Free text
105	evaluationProcedure	reference to the procedure information	O	1	Class	CI_Citation <<DataType>> (B 3.2)
106	dateTime	date or range of dates on which a data quality measure was applied	O	1	Class	DateTime (B.4.2)
107	result	value (or set of values) obtained from applying a data quality measure or the out come of evaluating the obtained value (or set of values) against a specified acceptable conformance quality level	M	2	Class	DQ_Result <<DataType>> (B.2.4.3)

## Appendix 4c-C

### Hydrographic Quality Metadata Attribute Definitions

#### **DQ\_AbsoluteExternalPositionalAccuracy**

Closeness of reported coordinative values to values accepted as or being true [per ISO 19115]

#### **Public Attributes:**

#### **meanValuePositionalUncertainties[0..1] : Real**

Mean value of the positional uncertainties for a set of positions where the positional uncertainties are defined as the distance between a measured position and what is considered as the corresponding true position. [adapted from ISO 19138]

#### **meanExcludingOutliers[0..1] : Real**

Mean value of the positional uncertainties, excluding outliers. For a set of points where the distance does not exceed a defined threshold, the arithmetical average of distances between their measured positions and what is considered as the corresponding true positions. [adapted from ISO 19138]

#### **numberOfPositionalUncertaintiesAboveThreshold[0..1] : Integer**

Number of positional uncertainties above a given threshold for a set of positions. The errors are defined as the distance between a measured position and what is considered as the corresponding true position. [adapted from ISO 19138]

#### **rateOfPositionalErrorsAboveThreshold[0..1] : Real**

Number of positional uncertainties above a given threshold for a set of positions in relation to the total number of measured positions. The errors are defined as the distance between the measured position and what is considered as the corresponding true position. [adapted from ISO 19138]

#### **covarianceMatrix[0..1] : Real Matrix**

Symmetrical square matrix with variances of point coordinates on the main diagonal and covariances between these coordinates as off diagonal elements. [adapted from ISO 19138]

#### **linearErrorProbable[0..1] : Real**

Half length of the interval defined by an upper and lower limit in which the true value lies with probability 50%. [adapted from ISO 19138]

#### **standardLinearError[0..1] : Real**

Half length of the interval defined by an upper and lower limit in which the true value lies with probability 68.3%. [adapted from ISO 19138].

#### **linearMapAccuracy2Sigma[0..1] : Real**

Half length of the interval defined by an upper and lower limit in which the true value lies with probability 90%. [adapted from ISO 19138].

**linearMapAccuracy3Sigma[0..1] : Real**

Half length of the interval defined by an upper and lower limit in which the true value lies with probability 95%. [adapted from ISO 19138].

**linearMapAccuracy4Sigma[0..1] : Real**

Half length of the interval defined by an upper and lower limit in which the true value lies with probability 99%. [adapted from ISO 19138].

**nearCertaintyLinearError[0..1] : Real**

Half length of the interval defined by an upper and lower limit in which the true value lies with probability 99.8%. [adapted from ISO 19138].

**RMSError[0..1] : Real**

Standard deviation where the true value is not estimated from the observations but known apriori. [adapted from ISO 19138].

**circularStandardDeviation[0..1] : Real**

Radius describing a circle in which the true point location lies with the probability of 39.4%. [adapted from ISO 19138].

**circularErrorProbable[0..1] : Real**

Radius describing a circle in which the true point location lies with the probability of 50%. [adapted from ISO 19138].

**circularMapAccuracyStandard[0..1] : Real**

Radius describing a circle in which the true point location lies with the probability of 90%. [adapted from ISO 19138].

**circularError95[0..1] : Real**

Radius describing a circle in which the true point location lies with the probability of 95%. [adapted from ISO 19138].

**circularNearCertaintyError[0..1] : Real**

Radius describing a circle in which the true point location lies with the probability of 99.8%. [adapted from ISO 19138].

**RMSErrorPlanimetry[0..1] : Real**

Radius of a circle around a given point in which the true value lies with true value P. [adapted from ISO 19138].

**CMSError[0..1] : Real**

The absolute horizontal accuracy of the data's coordinates expressed in terms of circular error at 90% probability given that a bias is present, per the equation in table D.48 in ISO 19138. [adapted from ISO 19138].

**ACE\_CE90[0..1] : Real**

The absolute horizontal accuracy of the data's coordinates expressed in terms of circular error at 90% probability given that a bias is present, per the equation in table D.49 in ISO 19138. [adapted from ISO 19138].



**uncertaintyEllipse[0..1] : Record**

A 2D ellipse with the two main axes indicating the direction and magnitude of the highest and lowest uncertainty of a 2D point. The data values are a record of real numbers corresponding to "phi" the bearing of the major semi-axis, and "a" and "b" the length of the two axes, per the equations in Table D.50 of ISO 19138. [adapted from ISO 19138].

**confidenceEllipse[0..1] : Record**

A 2D ellipse with the two main axes indicating the direction and magnitude of the highest and lowest uncertainty of a 2D point. The data values are a record of real numbers corresponding to "phi" the bearing of the major semi-axis, and "a" and "b" the length of the two axes, per the equations in Table D.51 of ISO 19138 and a significance level parameter. [adapted from ISO 19138].

**DQ\_AccuracyOfATimeMeasurement**

Correctness of the temporal references of an item (reporting of error in time measurement) [per ISO 19115]

**Public Attributes:****attributeValueUncertaintyMean[0..1] : Real**

This data quality measure indicates the attribute value of uncertainty where half the length of the interval defined by an upper and lower limit in which the true value for the quantitative attribute lies with a probability of 50%. [adapted from ISO 19138]

**attributeValueUncertainty1Sigma[0..1] : Real**

This data quality measure indicates the attribute value of uncertainty where half the length of the interval defined by an upper and lower limit in which the true value for the quantitative attribute lies with a probability of 68.3%. [adapted from ISO 19138]

**attributeValueUncertainty2Sigma[0..1] : Real**

This data quality measure indicates the attribute value of uncertainty where half the length of the interval defined by an upper and lower limit in which the true value for the quantitative attribute lies with a probability of 90%. [adapted from ISO 19138]

**attributeValueUncertainty3Sigma[0..1] : Real**

This data quality measure indicates the attribute value of uncertainty where half the length of the interval defined by an upper and lower limit in which the true value for the quantitative attribute lies with a probability of 95%. [adapted from ISO 19138]

**attributeValueUncertainty4Sigma[0..1] : Real**

This data quality measure indicates the attribute value of uncertainty where half the length of the interval defined by an upper and lower limit in which the true value for the quantitative attribute lies with a probability of 99%. [adapted from ISO 19138]

**attributeValueUncertainty5Sigma[0..1] : Real**

This data quality measure indicates the attribute value of uncertainty where half the length of the interval defined by an upper and lower limit in which the true value for the quantitative attribute lies with a probability of 99.8%. [adapted from ISO 19138]

**DQ\_CompletenessCommission**

Excess data present in a data set [per ISO 19115]

**Public Attributes:****excessItem[0..1] : Boolean**

This data quality measure indicates that an item is incorrectly present in the data [adapted from ISO 19138]

This is a Boolean where TRUE indicates that the item is in excess.

**numberOfExcessItems[0..1] : Integer**

This data quality measure indicates the number of items in the dataset, that should not have been in the dataset [adapted from ISO 19138]

This is an INTEGER count of the number of excess items.

**rateOfExcessItems[0..1] : Real**

This data quality measure indicates the number of excess items in the dataset in relation to the number of items that should have been present [adapted from ISO 19138]

This is a RATE which is a ratio, and is expressed as a REAL number representing the rational fraction corresponding to the numerator and denominator of the ratio.

For example, if there are 5 measured values and 4 valid values then the ratio is 5/4 and the reported rate = 1.25

**numberOfDuplicateFeatureInstances[0..1] : Integer**

This data quality measure indicates the total number of exact duplications of feature instances within the data. This is a count of all items in the data that are incorrectly extracted with duplicate geometries [adapted from ISO 19138]

This is an integer representing the error count.

**DQ\_CompletenessOmission**

This data absent from a data set [per ISO 19115]

**Public Attributes:****missingItem[0..1] : Boolean**

This data quality measure is an indicator that shows that a specific item is missing in the data. [adapted from ISO 19138]

This is a Boolean where TRUE indicates that an item is missing.

**numberOfMissingItems[0..1] : Integer**

This data quality measure indicates the count of all items that should have been in the dataset and are missing. [adapted from ISO 19138]

This is an INTEGER count of the number of missing items.

**rateOfMissingItems[0..1] : Real**

This data quality measure indicates the number of missing items in the dataset in relation to the number of items that should have been present. [adapted from ISO 19138]

This is a RATE which is a ratio, and is expressed as a REAL number representing the rational fraction corresponding to the numerator and denominator of the ratio.

For example, if there are 3 measured values and 5 values are required the ratio is 3/5 and the reported rate = 0.6

**DQ\_ConceptualConsistency**

Adherence to the rules of a conceptual schema [per ISO 19115]

**Public Attributes:****conceptualSchemaNonCompliance[0..1] : Boolean**

This data quality measure is an indication that an item is not compliant to the rules of the relevant conceptual schema [adapted from ISO 19138]

This is a Boolean where TRUE indicates that an item is not compliant with the rules of the conceptual schema

**conceptualSchemaCompliance[0..1] : Boolean**

This data quality measure is an indication that an item complies with the rules of the relevant conceptual schema [adapted from ISO 19138]

This is a Boolean where TRUE indicates that an item is in compliance with the rules of the conceptual schema

**numberOfNonCompliantItems[0..1] : Integer**

This data quality measure is a count of all items in the dataset that are noncompliant to the rules of the conceptual schema. If the conceptual schema explicitly or implicitly describes rules, these rules have to be followed. Violations against such rules, for example; can be invalid placement of features within a defined tolerance, duplication of features and invalid overlap of features. [adapted from ISO 19138]

This is an integer count.

**numberOfInvalidSurfaceOverlaps[0..1] : Integer**

This data quality measure is a count of the total number of erroneous overlaps within the data. Which surfaces may overlap and which must not is application dependent. Not all overlapping surfaces are necessarily erroneous. When reporting this data quality measure the types of feature classes corresponding to the illegal overlapping surfaces have to be reported as well. [adapted from ISO 19138] The allowable topological levels are described in the IHO/DGIWG joint profile of ISO 19107 Geographic Information Spatial Schema. Which particular topological structure may be used with a specific dataset is defined in the Product Specification for that type of data product, e.g. "Chain Node Topology" for IHO S-101.

This is an error count.

**nonComplianceRate[0..1] : Real**

This data quality measure indicates the number of items in the dataset that are noncompliant to the rules of the conceptual schema in relation to the total number of these items that are expected to be in the dataset. [adapted from ISO 19138]

This is a RATE which is a ratio, and is expressed as a REAL number representing the rational fraction corresponding to the numerator and denominator of the ratio.

For example, if there are 5 items that are non compliant and there are 100 of the items in the dataset then the ratio is 5/100 and the reported rate = 0.05

**complianceRate[0..1] : Real**

This data quality measure indicates the number of items in the dataset that are in compliance with the rules of the conceptual schema in relation to the total number of these items that are expected to be in the dataset. [adapted from ISO 19138]

This is a RATE which is a ratio, and is expressed as a REAL number representing the rational fraction corresponding to the numerator and denominator of the ratio.

For example, if there are 95 items that are compliant and there are 100 of the items in the dataset then the ratio is 95/100 and the reported rate = 0.95

**DQ\_DomainConsistency**

Adherence of the values to the value domains [per ISO 19115]

**Public Attributes:****valueDomainNonConformance[0..1] : Boolean**

This data quality measure is an indication that an item is not in conformance with its value domain. [adapted from ISO 19138]

This is a Boolean where TRUE indicates that an item is not in conformance with its value domain.

**valueDomainConformance [0..1] : Boolean**

This data quality measure is an indication that an item is conforming to its value domain [adapted from ISO 19138]

This is a Boolean where TRUE indicates that an item conforming to its value domain.

**numberOfNonconformantItems[0..1] : Integer**

This data quality measure is a count of all items in the dataset that are not in conformance with their value domain. [adapted from ISO 19138]

This is an integer count.

**valueDomainConformanceRate[0..1] : Real**

This data quality measure indicates the number of items in a the dataset that are in conformance with their value domain in relation to the total number of items in the dataset [adapted from ISO 19138]

This is a RATE which is a ratio, and is expressed as a REAL number representing the rational fraction corresponding to the numerator and denominator of the ratio.

For example, if there are 95 items that are in conformance and there are 100 of the items in the dataset then the ratio is 95/100 and the reported rate = 0.95

**valueDomainNonConformanceRate[0..1] : Real**

This data quality measure indicates the number of items in a the dataset that are not in conformance with their value domain in relation to the total number of items in the dataset. [adapted from ISO 19138]

This is a RATE which is a ratio, and is expressed as a REAL number representing the rational fraction corresponding to the numerator and denominator of the ratio.

For example, if there are 5 items that are in conformance and there are 100 of the items in the dataset then the ratio is 5/100 and the reported rate = 0.05

**DQ\_FormatConsistency**

Degree to which data is stored in accordance with the physical structure of the data set. [per ISO 19115]

**Public Attributes:****physicalStructureConflicts[0..1] : Integer**

This data quality measure is a count of all items in the dataset that are stored in conflict with the physical structure of the dataset. [adapted from ISO 19138]

This is an integer count.

**physicalStructureConflictRate[0..1] : Real**

This data quality measure indicates the number of items in the dataset that are stored in conflict with the physical structure of the dataset divided by the total number of items. [adapted from ISO 19138]

This is a RATE which is a ratio, and is expressed as a REAL number representing the rational fraction corresponding to the numerator and denominator of the ratio.

For example, if there are 3 items that are in conflict and there are 100 of the items in the dataset then the ratio is 3/100 and the reported rate = 0.03

**DQ\_GriddedDataPositionalAccuracy**

Closeness of gridded data position values to values to values accepted as or being true. [per ISO 19113]

**Public Attributes:****circularStandardDeviation[0..1] : Real**

Radius describing a circle in which the true point location lies with the probability of 39.4%. [adapted from ISO 19138].

**circularErrorProbable[0..1] : Real**

Radius describing a circle in which the true point location lies with the probability of 50%. [adapted from ISO 19138].

**circularMapAccuracyStandard[0..1] : Real**

Radius describing a circle in which the true point location lies with the probability of 90%. [adapted from ISO 19138].

**circularError95[0..1] : Real**

Radius describing a circle in which the true point location lies with the probability of 95%. [adapted from ISO 19138].

**circularNearCertaintyError[0..1] : Real**

Radius describing a circle in which the true point location lies with the probability of 99.8%. [adapted from ISO 19138].

**RMSErrorPlanimetry[0..1] : Real**

Radius of a circle around a given point in which the true value lies with true value P. [adapted from ISO 19138].

**CMSError[0..1] : Real**

The absolute horizontal accuracy of the data's coordinates expressed in terms of circular error at 90% probability given that a bias is present, per the equation in table D.48 in ISO 19138. [adapted from ISO 19138].

**ACE\_CE90[0..1] : Real**

The absolute horizontal accuracy of the data's coordinates expressed in terms of circular error at 90% probability given that a bias is present, per the equation in table D.49 in ISO 19138. [adapted from ISO 19138].

**uncertaintyEllipse[0..1] : Record**

A 2D ellipse with the two main axes indicating the direction and magnitude of the highest and lowest uncertainty of a 2D point. The data values are a record of real numbers corresponding to "phi" the bearing of the major semi-axis, and "a" and "b" the length of the two axes, per the equations in Table D.50 of ISO 19138. [adapted from ISO 19138].

**confidenceEllipse[0..1] : Record**

A 2D ellipse with the two main axes indicating the direction and magnitude of the highest and lowest uncertainty of a 2D point. The data values are a record of real numbers corresponding to "phi" the bearing of the major semi-axis, and "a" and "b" the length of the two axes, per the equations in Table D.51 of ISO 19138 and a significance level parameter. [adapted from ISO 19138].

**DQ\_NonQuantitativeAttributeAccuracy**

Correctness of non-quantitative attribute [per ISO 19115]

**Public Attributes:****numberOfIncorrectAttributeValues[0..1] : Integer**

This data quality measure is count of the total number of erroneous attribute values within the relevant part of the dataset. It is a count of all attribute values where the value is incorrect. [adapted from ISO 19138]

**rateOfCorrectAttributeValues[0..1] : Real**

This data quality measure indicates the number of correct attribute values in relation to the total number of attribute values. [adapted from ISO 19138]

This is a RATE which is a ratio, and is expressed as a REAL number representing the rational fraction corresponding to the numerator and denominator of the ratio.

For example, if there are 97 correct attribute values and there are 100 attribute values in total in the dataset then the ratio is 97/100 and the reported rate = 0.97

**rateOfIncorrectAttributeValues[0..1] : Real**

This data quality measure indicates the number of attribute values where incorrect values are assigned in relation to the total number of attribute values. [adapted from ISO 19138]

This is a RATE which is a ratio, and is expressed as a REAL number representing the rational fraction corresponding to the numerator and denominator of the ratio.

For example, if there are 3 incorrect attribute values and there are 100 attribute values in total in the dataset then the ratio is 3/100 and the reported rate = 0.03

**S100\_QualityMetadata****DQ\_QuantitativeAttributeAccuracy**

Accuracy of a quantitative attribute [per ISO 19115]

**Public Attributes:****attributeValueUncertaintyMean[0..1] : Real**

This data quality measure indicates the attribute value of uncertainty where half the length of the interval defined by an upper and lower limit in which the true value for the quantitative attribute lies with a probability of 50%. [adapted from ISO 19138]

**attributeValueUncertainty1Sigma[0..1] : Real**

This data quality measure indicates the attribute value of uncertainty where half the length of the interval defined by an upper and lower limit in which the true value for the quantitative attribute lies with a probability of 68.3%. [adapted from ISO 19138]

**attributeValueUncertainty2Sigma[0..1] : Real**

This data quality measure indicates the attribute value of uncertainty where half the length of the interval defined by an upper and lower limit in which the true value for the quantitative attribute lies with a probability of 90%. [adapted from ISO 19138]

**attributeValueUncertainty3Sigma[0..1] : Real**

This data quality measure indicates the attribute value of uncertainty where half the length of the interval defined by an upper and lower limit in which the true value for the quantitative attribute lies with a probability of 95%. [adapted from ISO 19138]

**attributeValueUncertainty4Sigma[0..1] : Real**

This data quality measure indicates the attribute value of uncertainty where half the length of the interval defined by an upper and lower limit in which the true value for the quantitative attribute lies with a probability of 99%. [adapted from ISO 19138]

**attributeValueUncertainty5Sigma[0..1] : Real**

This data quality measure indicates the attribute value of uncertainty where half the length of the interval defined by an upper and lower limit in which the true value for the quantitative attribute lies with a probability of 99.8%. [adapted from ISO 19138]

**DQ\_RelativeInternalPositionalAccuracy**

Closeness of the relative positions of features in a dataset to their respective relative positions accepted as or being true. [per ISO 19115]

**Public Attributes:****relativeVerticalError[0..1] : Real**

An evaluation of the random errors of one relief feature to another in the same data set or on the same map/chart. It is a function of the random errors in the two elevations with respect to a common vertical datum. [adapted from ISO 19138].

**relativeHorizontalError[0..1] : Real**

An evaluation of the random errors in the horizontal position of one feature to another in the same data set or on the same map/chart. [adapted from ISO 19138].

**DQ\_TemporalConsistency**

Correctness of ordered events or sequences, if reported. [per ISO 19115]

**Public Attributes:****temporalConsistencyStatement[0..1] : CharacterString**

This is a qualitative statement of the consistency of the time measurement. There is no qualitative measure provided for this data quality sub-element. [adapted from ISO 19138]

**DQ\_TemporalValidity**

Validity of data with respect to time. [per ISO 19115]

**Public Attributes:****valueDomainNonConformance[0..1] : Boolean**

This data quality measure is an indication that an item is not in conformance with its value domain [adapted from ISO 19138]  
This is a Boolean where TRUE indicates that an item is not in conformance with its value domain



**valueDomainConformance[0..1] : Boolean**

This data quality measure is an indication that an item is conforming to its value domain. [adapted from ISO 19138]

This is a Boolean where TRUE indicates that an item is conforming to its value domain.

**numberOfNonConformantItems[0..1] : Integer**

This data quality measure is a count of all items in the dataset that are not in conformance with their value domain. [adapted from ISO 19138]

This is an integer count

**valueDomainConformanceRate[0..1] : Real**

This data quality measure indicates the number of items in a the dataset that are in conformance with their value domain in relation to the total number of items in the dataset. [adapted from ISO 19138]

This is a RATE which is a ratio, and is expressed as a REAL number representing the rational fraction corresponding to the numerator and denominator of the ratio.

**valueDomainNonConformanceRate[0..1] : Real**

This data quality measure indicates the number of items in a the dataset that are not in conformance with their value domain in relation to the total number of items in the dataset. [adapted from ISO 19138]

This is a RATE which is a ratio, and is expressed as a REAL number representing the rational fraction corresponding to the numerator and denominator of the ratio.

For example, if there are 5 items that are in conformance and there are 100 of the items in the dataset then the ratio is 5/100 and the reported rate = 0.05

**DQ\_ThematicClassificationCorrectness**

Comparison of the classes assigned to features or their attributes to a universe of discourse. [per ISO 19113]

For example; ground truth or reference dataset.

**Public Attributes:****numberOfIncorrectlyClassifiedItems[0..1] : Integer**

This data quality measure is a count of the number of incorrectly classified features. [adapted from ISO 19138]

This is an integer count.

**miscalculationRate[0..1] : Real**

This data quality measure indicates the number of incorrectly classified features in relation to the number of features that are supposed to be there. [adapted from ISO 19138]

This is a RATE which is a ratio, and is expressed as a REAL number representing the rational fraction corresponding to the numerator and denominator of the ratio.

For example, if there are 1 items that are classified incorrectly and there are 100 of the items in the dataset then the ratio is 1/100 and the reported rate = 0.01

**misclassificationMatrix[0..1] : Integer Matrix**

This data quality measure is a matrix of integer numbers that indicates the number of items of class (i) classified as class (j). The misclassification matrix is a quadratic matrix with n columns and n rows where n denotes the number of classes under consideration.  $MCM(i,j) = (\# \text{ items of class (i) classified as class (j)})$ . The diagonal elements of the misclassified matrix contain the correctly classified items, and the off diagonal items contain the number of misclassified errors. [adapted from ISO 19138]

**relativeMisclassificationMatrix[0..1] : Real Matrix**

This data quality measure is a matrix of real numbers that indicates the number of items of class (i) classified as class (j) divided by the number of items of class (i) \* 100 represented as a percentage. The misclassification matrix has n columns and n rows where n denotes the number of classes under consideration.  $RMCM(i,j) = (\# \text{ items of class (i) classified as class (j)} / \text{number of items of class (i)}) * 100$ . [adapted from ISO 19138]

**kappaCoefficient[0..1] : Real**

This data quality measure is real number coefficient to quantify the proportion of agreement of assignments to classes by removing misclassifications. [adapted from ISO 19138]

**DQ\_TopologicalConsistency**

Measures of the topological consistency of geometric representations of features. [Adapted from ISO 19138]

Note: in ISO 19115, this is “Correctness of the explicitly encoded topological characteristics of a dataset”, but ISO 19138 states that the measures “will not serve as measures of the consistency of explicit descriptions of topology using the topological objects specified in ISO 19107”, and S-100 does not explicitly encode geometry.

**Public Attributes:****numberOfFaultyPointCurveConnections[0..1] : Integer**

This data quality measure is a count of the number of faulty point-curve connections in the dataset. A point curve connection exists where different curves touch. These curves have an intrinsic topological relationship that has to reflect the true constellation. e.g. two point-curve connections exist when there should only be one. [adapted from ISO 19138]

This is an integer count.

**rateOfFaultyPointCurveConnections[0..1] : Real**

This data quality measure indicates the number of faulty link-node connections in relation to the number of supposed link-node connections. This data quality measure gives the erroneous point-curve connections in relation to the total number of point-curve connections. [adapted from ISO 19138]

This is a RATE which is a ratio, and is expressed as a REAL number representing the rational fraction corresponding to the numerator and denominator of the ratio.

For example, if there are 2 items that are faulty link-node connections and there are 100 of the connections in the dataset then the ratio is 2/100 and the reported rate = 0.02

**numberOfMissingConnectionsUndershoots[0..1] : Integer**

This data quality measure is a count of items in the dataset within the parameter tolerance that are mismatched due to undershoots. [adapted from ISO 19138]

This is an integer count.

**numberOfMissingConnectionsOvershoots[0..1] : Integer**

This data quality measure is a count of items in the dataset within the parameter tolerance that are mismatched due to overshoots. [adapted from ISO 19138]

This is an integer count.

**numberOfInvalidSlivers[0..1] : Integer**

This data quality measure is a count of all items in the dataset that are invalid sliver surfaces. A sliver is an unintended area that occurs when adjacent surfaces are not digitized properly. The borders of the adjacent surfaces may unintentionally gap or overlap to cause a topological error. [adapted from ISO 19138]

This is an integer count.

**numberOfInvalidSelfIntersects[0..1] : Integer**

This data quality measure is a count of all items in the dataset that illegally intersect with themselves. ISO 19138]

This is an integer count.

**numberOfInvalidSelfOverlaps[0..1] : Integer**

This data quality measure is a count of all items in the dataset that illegally self-overlap [adapted from ISO 19138]

This is an integer count.

# **S-100 – Part 5**

## **Feature Catalogue**

## Contents

5-1	Scope .....	1
5-2	Conformance .....	1
5-3	Normative References.....	1
5-4	Principal Requirements .....	2
5-4.1	Feature Catalogue.....	2
5-4.2	Information Elements .....	2
5-4.2.1	Introduction.....	2
5-4.2.2	Named Types .....	2
5-4.2.3	Properties .....	5
5-4.2.4	Feature Associations.....	5
5-4.2.5	Bindings.....	6
5-4.2.6	Definitions and source references.....	6
5-4.2.7	Completeness .....	6
Appendix	5-A Feature Catalogue Model .....	7

## 5-1 Scope

This Part provides a standard framework for organizing and reporting the classification of real world phenomena in a set of geographic data. It defines the methodology for classification of the feature types and specifies how they are organized in a feature catalogue and presented to the users of a set of geographic data. This methodology is applicable to creating catalogues of feature types in previously uncatalogued domains and to revising existing feature catalogues to comply with standard practice. It applies to the cataloguing of feature types that are represented in digital form. Its principles can be extended to the cataloguing of other forms of geographic data.

A feature catalogue shall be defined for each product specification.

This Part is applicable to the definition of geographic features at the type level but not applicable to the representation of individual instances of each type.

## 5-2 Conformance

This profile conforms to conformance class 2 of ISO 19106:2004. The following is a brief description of the specializations and generalizations where the profile differs from ISO 19110.

- 1) New abstract classes, *S100\_FC\_Item*, *S100\_FC\_NamedType*, and *S100\_FC\_ObjectType* are introduced.
- 2) A new class, *S100\_FC\_InformationType* is introduced.
- 3) New classes, *S100\_FC\_FeatureBinding*, *S100\_FC\_InformationBinding* and *S100\_FC\_AttributeBinding* are introduced.
- 4) A new class, *S100\_CD\_AttributeConstraints* is introduced.
- 5) The class *FC\_FeatureAttribute* is specialized to be the abstract class *S100\_FC\_Attribute*.
- 6) New classes, *S100\_FC\_SimpleAttribute* and *S100\_FC\_ComplexAttribute* are introduced.
- 7) The classes *FC\_InheritanceRelation*, *FC\_FeatureOperation*, *FC\_Binding*, *FC\_Constraint* and *FC\_BoundFeatureAttribute* are not used.

Further reference or explanation of the above changes can be found in the following text where appropriate.

## 5-3 Normative References

The following referenced documents are required for the application of this document. For dated references, only the edition cited applies. For undated references, the latest edition of the referenced document (including amendments) applies.

ISO 19110:2005, Geographic Information – Methodology for feature cataloguing

## 5-4 Principal Requirements

### 5-4.1 Feature Catalogue

An S-100 based feature catalogue presents the abstraction of reality represented in one or more sets of geographic data as a defined classification of phenomena. The basic level of classification in the feature catalogue is the feature type. Features and attributes are bound in a feature catalogue. The definitions of features and attributes are drawn from a feature concept dictionary. A feature catalogue shall be available in electronic form (e.g. XML) for any set of geographic data that contains features. A feature catalogue may also comply with the specifications of this component of S-100 independently of any existing set of geographic data.

### 5-4.2 Information Elements

#### 5-4.2.1 Introduction

The following clauses specify general and specific requirements for feature catalogue information elements. A feature catalogue generally consists of a list of named types, a list of properties for named types and the information on how both are linked together. Furthermore it contains a list of sources for its definitions. The model is primarily based on the ISO 19110 standard but there are both extensions and differences in this model.

There are two major extensions to the feature types: information types and complex attributes. To achieve a greater flexibility in modelling the data within a data set it is necessary to define complex structures of information. Both extensions allow the creation of those structures. Whereas complex attributes define complex characteristics for one named type, information types can be shared.

Unlike feature types, which are an abstraction of real world phenomena, information types are just shareable structured pieces of information. In a geographic data set they will be associated to feature types or to other information types. Both types: feature and information, have many common characteristics. This is accommodated by deriving both types from a common abstract base class: the named type.

Complex attributes are an aggregation of other attributes which may be either simple or complex.

The arrangement of content may be different depending on format e.g printed document, XML, hypertext etc.

#### 5-4.2.2 Named Types

##### 5-4.2.2.1 Common Characteristics

Feature and information types are inherited (see 5-4.2.2.2 below) from the abstract class *S100\_FC\_NamedType*. This class describes all common characteristics, for example, the name and the definition of the corresponding type. Furthermore a code has to be defined for the type. This code will later be used to identify an instance of a named type in a geographic data set. If the definition is taken from a feature concept dictionary that reference is also given.

Feature and information types can be derived from other feature or information types. This includes the possibility that some types are abstract, i.e., no instances of such types can be in a data set. Named types can be characterized by attributes and additional information may be available by information types that are related to them. The former is defined by attribute bindings whereas the latter is achieved by information bindings.

##### 5-4.2.2.2 Inheritance

In data modelling, inheritance is a way to form new types using types that have already been defined. The new types, known as derived types (or sub-types), take over (or inherit) properties of the pre-existing types, which are referred to as base types (or super types). The derived types may define new additional properties, but also change existing properties, the latter is called overriding. This is used to assign unique property values to sub-types such as name and definition but overriding of characteristics such as bindings to attributes should be avoided by only including common characteristics in the super type. In the scope of a feature catalogue both feature and information types can be derived from other feature or information

types. But a feature type cannot be derived from an information type or vice versa. Attributes and associations defined for the super type will also belong to the sub type. The definition of the sub type is usually redefined. In the context of this standard inheritance will be always simple, i.e. each type cannot be derived from more than one super type.

**EXAMPLE 1** Cardinal and lateral buoys may be derived from an (abstract) type buoy. The super type already defines attributes like colour, shape, name, and associations to lights or top marks. The derived types add special information only valid for the specialized type like category of cardinal mark or category of lateral mark respectively.

Inheritance builds hierarchical structures which may become difficult to manage if they are too complex or not sufficiently mature. It is generally good design practice to keep the depth of an inheritance tree as shallow as possible. **On the other hand, sometimes inheritance trees simplify models by grouping types which are derived from the same basic concept and which have the same characteristics, so inheritance even at multiple levels should be used where appropriate.**

Inheritance relationships between types in a feature catalogue generally correspond to inheritance relationships in the application schema. Determinations of when to use inheritance and to what degree and level are information modeling questions and should be addressed by application schema designers and project teams taking into consideration factors such as application schema and feature catalogue complexity, maintenance, application requirements, etc.

**EXAMPLE 2** In the information model for the ENC product specification, all geographic feature types have information bindings to the information type *SupplementaryInformation* and feature bindings to the cartographic feature *TextAssociation*. Defining a common super-type for all geographic features would allow these two bindings to be made to the super-type instead of repeating them in every geographic feature type.

**EXAMPLE 3:** In an application schema for an “Aids to Navigation” product specification, classes defining different types of beacons have many of the same attributes. Also, classes defining different types of buoys share the same characteristics. Super-types *GenericBuoy* and *GenericBeacon* are therefore defined. Further, buoys and beacons can all act as structure objects, and there are also other features which can also play the role of structure objects, so another super-type is introduced for generic structure features. *AidsToNavigation*, *StructureObject*, *GenericBuoy*, and *GenericBeacon* are all abstract classes. The Structure/Equipment association is made between the classes Structure and Equipment and applies to all sub-types of these classes, e.g. any *CardinalBuoy* can fill the parent role in a Structure/Equipment association with any sub-type of Equipment.



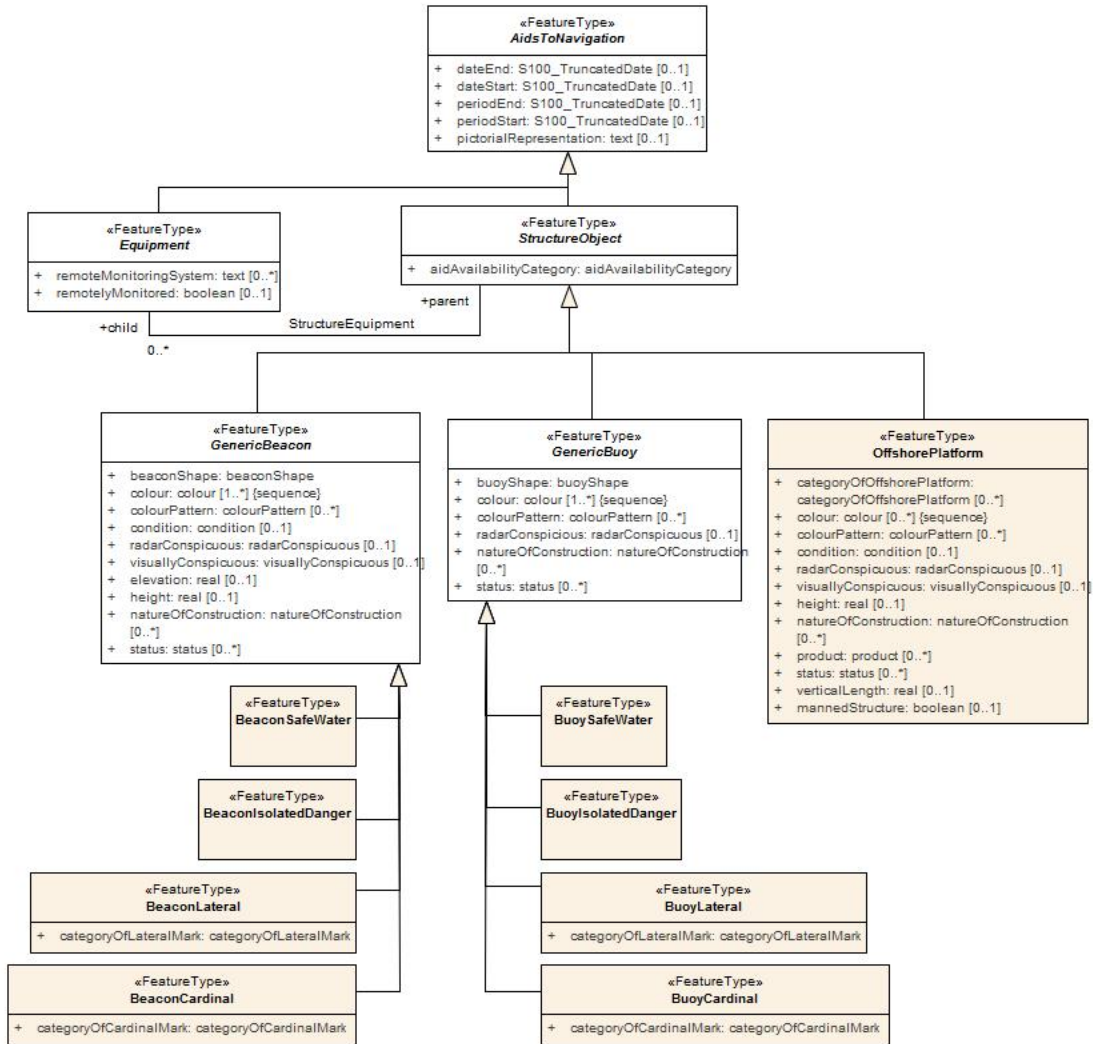


Figure 5-1. Inheritance Example

5-4.2.2.2.1. Considerations for product specifications (Informative)

In general the need for inheritance increases with increasing numbers of concepts which can be grouped under a higher-level concept, or as more characteristics are shared between similar types, or even if several different types share some characteristics.

The advantage of excluding inheritance from feature catalogues is mainly structural simplification (and consequently simpler processing) since abstract types and inheritance hierarchies need not be implemented; also in S-100-based product specifications, inherited enumerated attributes can have different lists of allowed values for different sub-types. The disadvantages include (probable) increases in the volume of the feature catalogue especially if many features or information types have common attributes or associations, and increased complexity for maintenance (an update to an attribute nominally bound to a super-type would have to be made to each sub-type at all levels, and this would have to be checked before the feature catalogue is released). Also, inheritance is a common paradigm in object-oriented programming and may not be a significant issue for implementations.

5-4.2.2.3 Feature Types

Feature types are the basic level of classification in the feature catalogue. In addition to the common characteristics they define a feature use type to categorize them. Feature types may be associated to other feature types through feature associations. This will be defined by feature bindings which specify the association as well as the role used for the relationship to the other feature type.

#### 5-4.2.2.4 Information Types

Information types are complex pieces of information in a data set that can be shared between many other feature or information types. In regards to their structure, they can also be seen as feature types without a geometric property which have a structure similar to feature types and are categorized as a separate item type.

#### 5-4.2.3 Properties

##### 5-4.2.3.1 Common Characteristics

Properties for feature and information types are attributes and association roles although the latter only applies to feature types. The common characteristics include name, definition, remarks etc. A reference to a feature concept dictionary may be defined.

##### 5-4.2.3.2 Attributes

Attributes carry the characteristics of feature and information types. Unlike information types they cannot be shared between different instances. i.e, an instance of an attribute belongs to one and only one feature or information type. In this standard there are two different kinds of attributes: simple and complex. Simple attributes carry the value itself, and complex attributes are aggregations of other attributes to achieve a complex and hierarchical data structure.

##### 5-4.2.3.3 Simple Attributes

Simple attributes are designed to carry a value. In the feature catalogue the domain of the value shall be specified. All attribute values are value types. Part 2a-4.2.10 contains the full list of value types and their definitions. If the value type is an enumeration, or a codelist of type "open enumeration," a list of 'Listed Values' will be defined. For codelists of type open or closed dictionary, a URI identifying a "dictionary" (or "vocabulary") will be provided as a definition.

Furthermore the value domain can be constrained by the following:

- 1) The length of the text
- 2) A format specification for structured text
- 3) A numeric range

Details are in Appendix 5-A

##### 5-4.2.3.4 Complex Attributes

Complex attributes are aggregations of other attributes that are either simple or complex. The aggregation is defined by means of attribute bindings.

##### 5-4.2.3.5 Association Roles

An association role describes the nature of the relationship from one feature type to another feature type in a feature association. In this standard each association has exactly two roles. Either or both may be a default. The documentation of application schemas must specify the rule used for default names. Different rules for default names may apply to different associations in the same application schema, but each role shall have an unambiguous name, be it an explicit role name or a default role name.

#### 5-4.2.4 Feature Associations

Feature associations describe the relationships between feature types. Feature associations have a name, definition, remarks, code etc. Each association uses two roles that define the directed use of the relationship. Either or both of the roles may be a default as described in Part 3.

EXAMPLE 1 Master – Slave is an example of an association with two roles.

EXAMPLE 2 theAuthority – theContactDetails is an example of an association between classes Authority and ContactDetails which uses two default roles.

## 5-4.2.5 Bindings

### 5-4.2.5.1 Attribute Bindings

The following use cases for Attribute bindings exist:

1. Defining the attribute for feature types
2. Defining the attributes for information types
3. Defining the attributes for feature associations
4. Defining the attributes for information associations
5. Defining the aggregation of attributes for a complex attribute.

The binding specifies the target attribute and the Multiplicity of the attribute. The Multiplicity indicates how many instances of an attribute can be used. Bindings are used to define whether an attribute is mandatory (1..n) or optional (0..n). If the Multiplicity allows more than one instance of an attribute a Boolean flag indicates if the sequence of attributes has a meaning.

If the attribute is a simple attribute with a data type of Enumeration, a list of permitted values can be specified. An empty list indicates that all values defined for the attribute in the feature catalogue are valid.

### 5-4.2.5.2 Feature Bindings

The feature binding describes the association between two feature types. Both the feature association and the association role are specified together with the target feature type. Furthermore the Multiplicity and the role type are defined. The latter describes the nature of the role.

**EXAMPLE** The role 'Lane' used by a traffic separation scheme to associate its lane parts will have the role type Aggregation, whereas the role "Scheme" used from the lane part to the TSS has the role type Association

### 5-4.2.5.3 Information Bindings

Information bindings describe which information types can be associated to which feature or information types. In addition to the target information type the Multiplicity of this binding is also defined.

## 5-4.2.6 Definitions and source references

### 5-4.2.6.1 Definition sources

This is a list of source documents for the definitions used in the feature catalogue. They are given with their citation information. Usually the definitions will come from a feature concept dictionary but other sources are possible. It is also valid that a definition originates from the feature catalogue; in this case there will be no reference to a definition source.

### 5-4.2.6.2 Definition references

This information carries the link to the definition source. It points to a definition source and defines the place in that source by means of an identifier. In cases where the source is a feature concept dictionary maintained as a register this reference will be the item identifier.

### 5-4.2.7 Completeness

A template for the representation of feature classification information is specified in the following model (Appendix 5-A (normative), Figure 5-A.1). A feature catalogue prepared according to this template shall document all of the feature types and information types found in a given set of geographic data. The feature catalogue shall include identification information as specified. The feature catalogue shall include definitions and descriptions of all feature and information types contained in the data, including any feature attributes and feature associations contained in the data that are associated with each feature type. To ensure predictability and comparability of feature catalogue content across different applications, it is recommended that the feature catalogue should include only the elements specified in the tables shown at Appendix 5-A (normative) below.

## Appendix 5-A

# Feature Catalogue Model

### (normative)

This appendix presents the S-100 feature catalogue. Figure 5-A-1 is the S-100 feature catalogue modelled in UML and Tables 5-A-1 to 5-A-20 illustrate the structure of the Feature Catalogue in conformance to the model shown.

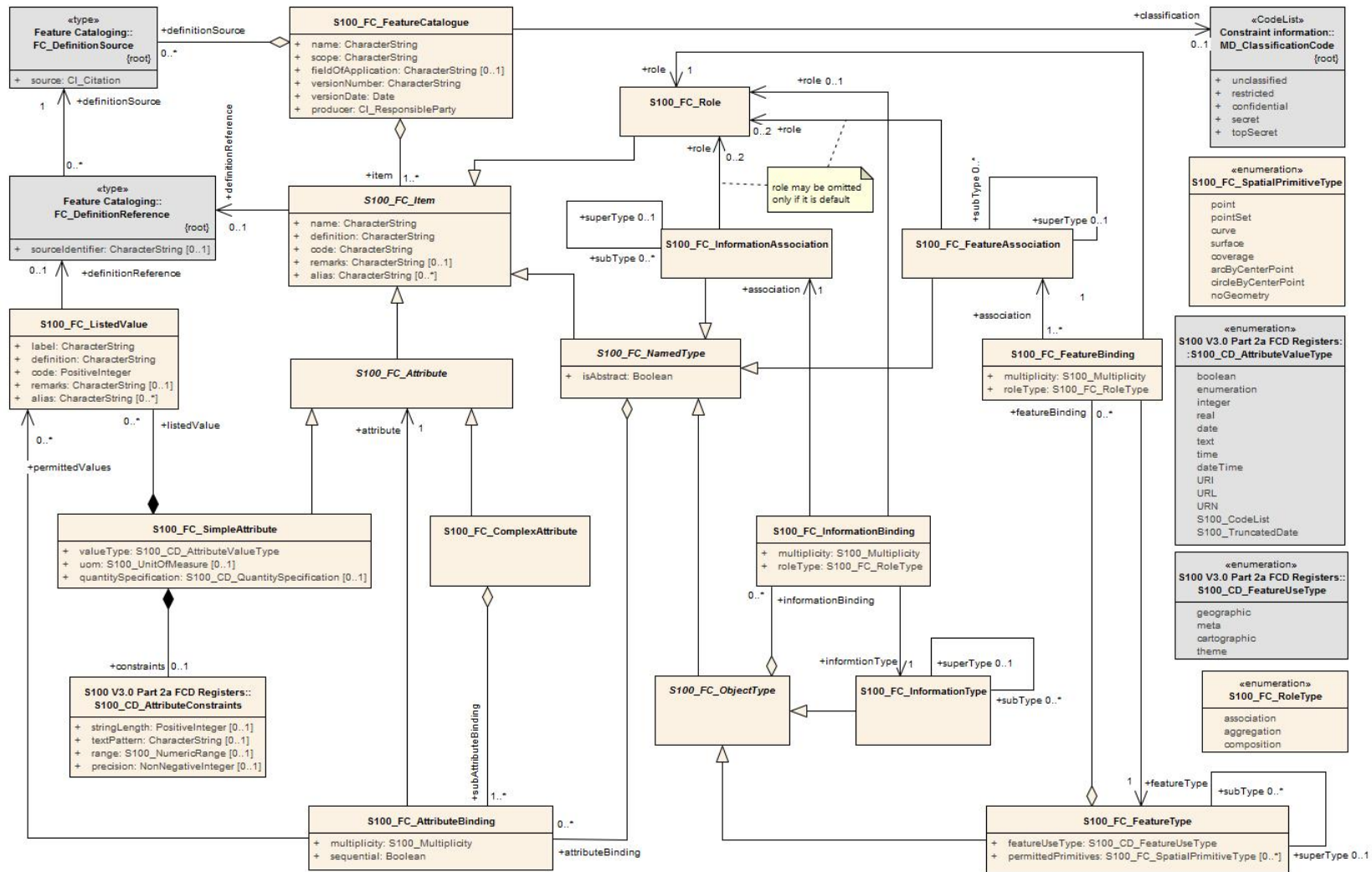


Figure 5-A-1. Feature Catalogue — UML Model

**Table 5-A-1 — S100\_FC\_FeatureCatalogue**

Role Name	Name	Description	Mult	Type	Remarks
Class	S100_FC_FeatureCatalogue	a feature catalogue contains its identification and contact information, and definition of some number of feature types with other information necessary for those definitions.	-	-	-
Attribute	name	name for this feature catalogue	1	CharacterString	
Attribute	scope	subject domain of feature types defined in this feature catalogue	1	CharacterString	
Attribute	fieldOfApplication	description of the kind of use to which this feature catalogue may be put	0..1	CharacterString	
Attribute	versionNumber	version number of this feature catalogue, which may include both a major version number or letter and a sequence of minor release numbers or letters, such as "3.2.4a." The format of this attribute may differ between cataloguing authorities.	1	CharacterString	
Attribute	versionDate	effective date of this feature catalogue	1	Date	
Attribute	producer	name, address, country, and telecommunications address of person or organization having primary responsibility for the intellectual content of this feature catalogue	1	CI_ResponsibleParty	
Role	item	list of items defined by this feature catalogue; items are feature types, information types, feature associations, information associations, attributes, and roles	1..*	S100_FC_Item	Aggregation
Role	definitionSource	list of sources of definitions of items and listed values that are defined by this feature catalogue. Usually those sources are feature data dictionaries.	0..*	FC_DefinitionSource	Aggregation
Role	classification	The classification of the feature catalogue.	0..1	MD_ClassificationCode	1. unclassified 2. Restricted 3. Confidential 4. secret 5. top secret

**Table 5-A-2 — FC\_DefinitionSource**

Role Name	Name	Description	Mult	Type	Remarks
Class	FC_DefinitionSource	class that specifies the source of a definition.	-	-	-
Attribute	source	actual citation of the source, sufficient to identify the document and how to obtain it	1	Cl_Citation	

**Table 5-A-3 — FC\_DefinitionReference**

Role Name	Name	Description	Mult	Type	Remarks
Class	FC_DefinitionReference	class that links a data instance to the source of its definition	-	-	-
Attribute	sourceIdentifier	information to locate the definition in the source document. The format of this information is specific to the structure of the source document.	1	CharacterString	Includes online dictionaries or "vocabularies" used by dictionary-type codelist attributes
Role	definitionSource	the source of the definition	1	FC_DefinitionSource	

**Table 5-A-4 — S100\_FC\_Item**

Role Name	Name	Description	Mult	Type	Remarks
Class	<i>S100_FC_Item</i>	abstract base class that defines the common properties of all items in the feature catalogue; items are feature types, information types, feature associations, information associations, attributes and roles	-	-	abstract class
Attribute	name	name of the item	1	CharacterString	
Attribute	definition	definition of the named type in a natural language.	1	CharacterString	
Attribute	code	code that uniquely identifies the named type within the feature catalogue.	1	CharacterString	
Attribute	remarks	further explanation about the item	0..1	CharacterString	
Attribute	alias	equivalent name(s) of this item	0..*	CharacterString	
Role	definitionReference	the link to the source of the definition	0..1	FC_DefinitionReference	

**Table 5-A-5 — S100\_FC\_NamedType**

Role Name	Name	Description	Mult	Type	Remarks
Class	<i>S100_FC_NamedType</i>	abstract base class that defines the common properties for feature types and information types	-	-	abstract class
Attribute	isAbstract	indicates if instances of this named type can exist in a geographic data set. Abstract types cannot be instantiated but serve as base classes for other (non-abstract) types.	1	Boolean	
Role	attributeBinding	list of bindings to attributes which describe the characteristic of this named type.	0..*	S100_FC_AttributeBinding	Aggregation

**Table 5-A-6 — S100\_FC\_ObjectType**

Role Name	Name	Description	Mult	Type	Remarks
Class	<i>S100_FC_ObjectType</i>	abstract base class that defines the common properties for feature types and information types	-	-	abstract class; derived from S100_FC_NamedType
Role	informationBinding	list of bindings to information types that can be associated to this object type by means of an information association	0..*	S100_FC_InformationBinding	Aggregation

**Table 5-A-7 — S100\_FC\_InformationType**

Role Name	Name	Description	Mult	Type	Remarks
Class	S100_FC_InformationType	class that defines all properties of an information type	-	-	Derived from S100_FC_NamedType
Role	superType	indicates the information type from which an information type is derived. The sub type will inherit all properties from its super type: name, definition and code will usually be overridden by the sub type, although new properties may be added to the sub type.	0..1	S100_FC_InformationType	
Role	subType	indicates the information types which are derived from an information type.	0..*	S100_FC_InformationType	



**Table 5-A-8 — S100\_FC\_FeatureType**

Role Name	Name	Description	Mult	Type	Remarks
Class	S100_FC_FeatureType	class that defines all properties of a feature type	-	-	derived from S100_FC_NamedType
Attribute	featureUseType	the use type of this feature type	1	S100_FC_FeatureUseType	
Attribute	permittedPrimitives	the combination of 0 or more spatial primitives permitted for feature type.	0..*	S100_FC_SpatialPrimitiveType	
Role	featureBinding	list of bindings to feature types that can be related to this feature type by means of a feature association	0..*	S100_FC_FeatureBinding	Aggregation
Role	superType	indicates the feature type from which a feature type is derived. The sub type will inherit all properties from its super type: name, definition and code will usually be overridden by the sub type, although new properties may be added to the sub type. If permittedPrimitives is present in a sub-type it overrides permittedPrimitives in any of its super-types.	0..1	S100_FC_FeatureType	
Role	subType	indicates the feature types which are derived from a feature type.	0..*	S100_FC_FeatureType	

Example: If a super-type allows point and area primitives and the sub-type only curve primitives, instances of the sub-type must indicate location with curve spatial objects. Sub-types of the sub-type will take only line primitives unless they specify their own permitted primitives.

**Table 5-A-9 — S100\_FC\_InformationAssociation**

Role Name	Name	Description	Mult	Type	Remarks
Class	S100_FC_InformationAssociation	an information association describes the relationship between an object (feature or information type) and an information type.	-	-	derived from S100_FC_NamedType Individual product specifications may restrict directionality.
Role	role	the role of the association	0..2	S100_FC_Role	default role name if missing. Product specification can constrain further.
Role	superType	Indicates the information association from which an information association is derived. The sub type will inherit all properties from its super type: name, definition and code will usually be overridden	0..1	S100_FC_InformationAssociation	

		by the sub type, although new properties may be added to the sub type.			
Role	subType	Indicates the information associations which are derived from an information association.	0..*	S100_FC_InformationAssociation	

**Table 5-A-10 — S100\_FC\_FeatureAssociation**

Role Name	Name	Description	Mult	Type	Remarks
Class	S100_FC_FeatureAssociation	a feature association describes the relationship between two feature types. A feature association is bidirectional and has a separate role for each direction.	-	-	
Role	role	the role of the association	0..2	S100_FC_Role	
Role	superType	Indicates the feature association from which an feature association is derived. The sub type will inherit all properties from its super type: name, definition and code will usually be overridden by the sub type, although new properties may be added to the sub type.	0..1	S100_FC_FeatureAssociation	
Role	subType	Indicates the feature associations which are derived from a feature association.	0..	S100_FC_FeatureAssociation	

**Table 5-A-11 — S100\_FC\_Role**

Role Name	Name	Description	Mult	Type	Remarks
Class	S100_FC_Role	a role which can be used in a feature association or an information association	-	-	derived from S100_FC_Item

**Table 5-A-12 — S100\_FC\_Attribute**

Role Name	Name	Description	Mult	Type	Remarks
Class	<i>S100_FC_Attribute</i>	abstract base class for the two kinds of attributes: simple attributes and complex attributes. Attributes carry the characteristics of named types	-	-	abstract derived from S100_FC_Item

**Table 5-A-13 — S100\_FC\_SimpleAttribute**

Role Name	Name	Description	Mult	Type	Remarks
Class	S100_FC_SimpleAttribute	attribute that carries a value	-	-	derived from S100_FC_Attribute
Attribute	valueType	the value type of this feature attribute	1	S100_CD_AttributeValueType	
Attribute	uom	unit of measure used for values of this feature attribute	0..1	S100_UnitOfMeasure	
Attribute	quantitySpecification	specification of the quantity	0..1	S100_CD_QuantitySpecification	
Role	constraints	constraints which may apply to the attribute	0..1	S100_FC_AttributeConstraints	Composition
Role	listedValue	set of listed values for an enumerated attribute domain	0..*	S100_FC_ListedValue	Composition. Applies only if valueType is Enumeration or S100_Codelist (with codelistType=open enumeration)

**Table 5-A-14 — S100\_FC\_ComplexAttribute**

Role Name	Name	Description	Mult	Type	Remarks
Class	S100_FC_ComplexAttribute	a complex attribute consists of a list of sub-attributes which can be both simple and complex attributes	-	-	derived from S100_FC_Attribute
Role	subAttributeBinding	list of attribute bindings to the sub-attributes	1..*	S100_FC_AttributeBinding	Aggregation

**Table 5-A-15 — S100\_FC\_ListedValue**

Role Name	Name	Description	Mult	Type	Remarks
Class	S100_FC_ListedValue	value of an enumerated attribute domain, including its codes and definition	-	-	
Attribute	label	descriptive label that uniquely identifies one value of the feature attribute	1	CharacterString	
Attribute	definition	definition of the listed value in a natural language.	1	CharacterString	
Attribute	code	numeric code that uniquely identifies the listed value for the corresponding feature attribute.	1	PositiveInteger	
Attribute	remarks	further explanation about the listed value	0..1	CharacterString	
Attribute	alias	equivalent name(s) of this listed value	0..*	CharacterString	
Role	definitionReference	the link to the source of the definition	0..1	FC_DefinitionReference	

**Table 5-A-16— S100\_FC\_AttributeBinding**

Role Name	Name	Description	Mult	Type	Remarks
Class	S100_FC_AttributeBinding	class that is used to describe the specifics of how an attribute is bound to a particular named type or a complex attribute	-	-	
Attribute	multiplicity	multiplicity defining how many instances of the attribute can be part of the named type or complex attribute	1	S100_Multiplicity	
Attribute	sequential	describes if the sequence of the attributes is meaningful or not	1	Boolean	Applies only to attributes which may occur more than once.
Role	permittedValues	permissible values of the attribute	0..*	S100_FC_ListedValue	Applies only to attributes of data type enumeration.
Role	attribute	the attribute that is bound to the item or complex attribute	1	S100_FC_Attribute	

**Table 5-A-17 — S100\_FC\_InformationBinding**

Role Name	Name	Description	Mult	Type	Remarks
Class	S100_FC_InformationBinding	class describing the use of an information type by a named type.	-	-	
Attribute	multiplicity	Multiplicity defining how many instances of the target information type can be linked to one instance of the named type	1	S100_Multiplicity	
Attribute	roleType	the nature of the association end	1	S100_FC_RoleType	
Role	role	the role used for the binding. It must be part of the association used for the binding and defines the end of the association.	0..1	S100_FC_Role	
Role	association	the association used for the binding; defining also the role	1	S100_FC_InformationAssociation	
Role	informationType	the target information type	1	S100_FC_InformationType	

**Table 5-A-18 — S100\_FC\_FeatureBinding**

Role Name	Name	Description	Mult	Type	Remarks
Class	S100_FC_FeatureBinding	class describing the relationship from one feature type to another feature type by means of a feature association	-	-	
Attribute	multiplicity	Multiplicity defining how many instances of the target feature type can be linked to one instance of the source feature type	1	S100_Multiplicity	
Attribute	roleType	the nature of the association end	1	S100_FC_RoleType	
Role	featureType	the target feature type	1	S100_FC_FeatureType	
Role	role	the role used for the binding. It must be part of the association used for the binding and defines the end of the association.	1	S100_FC_Role	
Role	association	the association used for the binding.	1	S100_FC_FeatureAssociation	

**Table 5-A-19 — S100\_FC\_RoleType**

Role Name	Name	Description	Remarks
Enumeration	S100_FC_RoleType	defines the type of a role	
Literal	association	an association is used to describe a relationship between two feature types that involves connections between their instances	
Literal	aggregation	an aggregation association is a relationship between two feature types, in which one of the feature types plays the role of a container and the other plays the role of a containee.	
Literal	composition	a composition association is a strong aggregation. In a composition association, if a container object is deleted then all of its containee objects are deleted as well. In other words containee objects cannot exist without the container object.	

**Table 5-A-20 — S100\_FC\_SpatialPrimitiveType**

<b>Role Name</b>	<b>Name</b>	<b>Description</b>	<b>Remarks</b>
Enumeration	S100_FC_SpatialPrimitiveType	specifies spatial primitives permitted for use with a feature instance	
Literal	point	point spatial primitive	<b>GM_Point</b>
Literal	pointSet	point set spatial primitive	<b>GM_MultiPoint</b>
Literal	curve	curve spatial primitive	<b>GM_Curve</b>
Literal	surface	surface spatial primitive	<b>GM_Surface</b>
Literal	coverage	coverage spatial primitive	<b>CV_Coverage</b>
Literal	arcByCenterPoint	curve spatial primitive with arc described by centre, radius, and angle geometry	<b>GM_Curve with only S100_ArcByCenterPoint curve segments</b>
Literal	circleByCenterPoint	curve spatial primitive with circle described by centre and radius geometry	<b>GM_Curve with only S100_CircleByCenterPoint curve segments</b>
Literal	noGeometry	the feature type is not associated with a spatial primitive for the location of instances	In some cases, an explicit statement is needed to indicate that there are no spatial primitives for the locations of instances. See the rules for subtypes and super-types in S100_FC_FeatureType

# **S-100 – Part 6**

## **Coordinate Reference Systems**

## Contents

6-1	Scope .....	1
6-2	Normative References.....	1
6-3	Package Overview .....	2
6-3.1	The package diagram.....	2
6-4	Package details .....	2
6-4.1	The Identified Object package.....	2
6-4.1.1	S100_IO_IdentifiedObject .....	3
6-4.1.2	Class details .....	3
6-4.2	The Coordinate Reference Systems package .....	4
6-4.3	Single CRS.....	4
6-4.3.1	Compound CRS .....	5
6-4.3.2	Class details .....	5
6-4.4	The Coordinate System package.....	6
6-4.4.1	Class details .....	7
6-4.5	The Datum package .....	9
6-4.5.1	Class details .....	10
6-4.6	The Coordinate Operation package .....	12
6-4.6.1	Class details .....	14
Appendix 6-A	Examples .....	16



## 6-1 Scope

The S-100 standard has been designed for the producers and users of hydrographic information, however its principles can be extended to many other forms of geographic information including maps, and text documents.

The location of an object in the S-100 standard is defined by means of coordinates. Those coordinates relate a feature to a position. This Part describes all elements that are necessary to fully define the referencing by means of coordinate systems and datums. It defines the conceptual schema for the description of spatial referencing by coordinates and describes the minimum data required to define 1-, 2- and 3-dimensional spatial coordinate references.

In addition to the elements necessary to define a coordinate reference system this Part also describes operations to transform coordinates from one coordinate reference system to another. This includes operations for datum transformation and map projections.

Coordinate reference systems, as well as single elements to define them, may be registered in a register or defined by an organization in a document. This Part describes how those elements are identified.

A coordinate reference system shall not change with time within the scope of this Part.

## 6-2 Normative References

The following referenced documents are indispensable for the application of this document. For dated references, only the cited edition applies. For undated references, the latest edition of the referenced document (including any amendments) applies.

ISO 19111:2007, Geographic information — Spatial referencing by coordinates

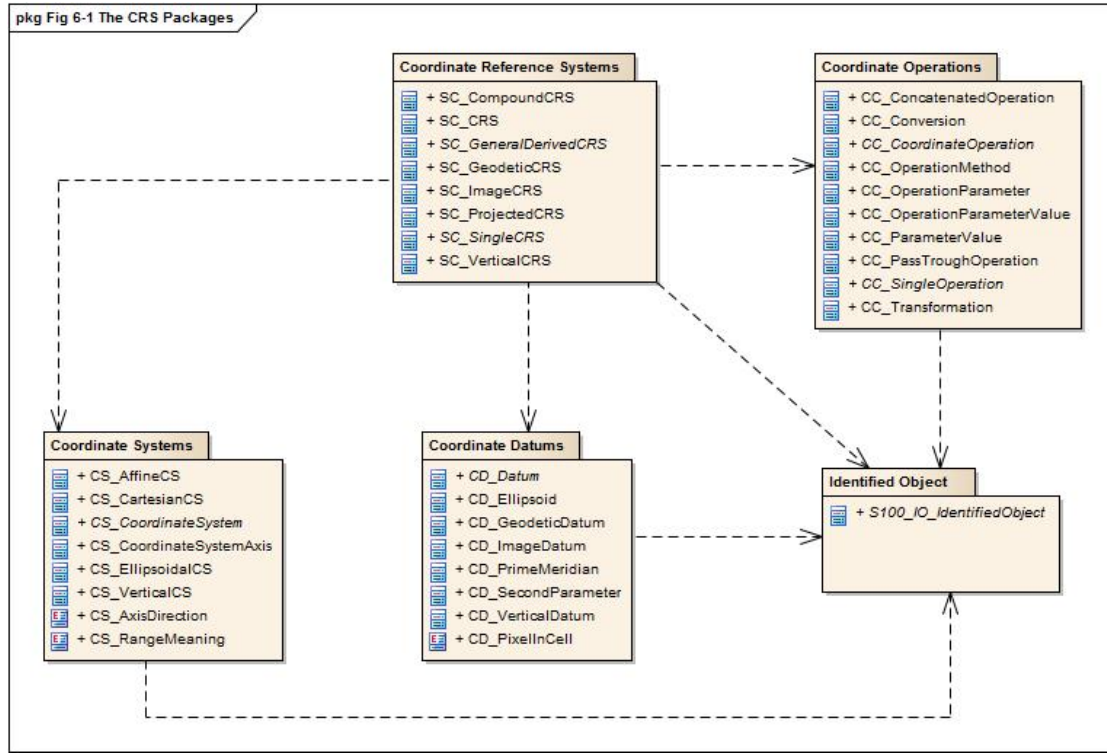
ISO/TS 19103, Geographic information — Conceptual schema language

ISO 19115, Geographic information — Metadata

### 6-3 Package Overview

#### 6-3.1 The package diagram

Figure 6.1 shows the packages used in this Part and their dependencies.



**Figure 6-1 — The CRS packages**

The elements for referencing spatial objects by use of coordinates are described in five packages. All packages depend on the package “Identified Objects”, which describes the mechanism of linking elements to external definitions.

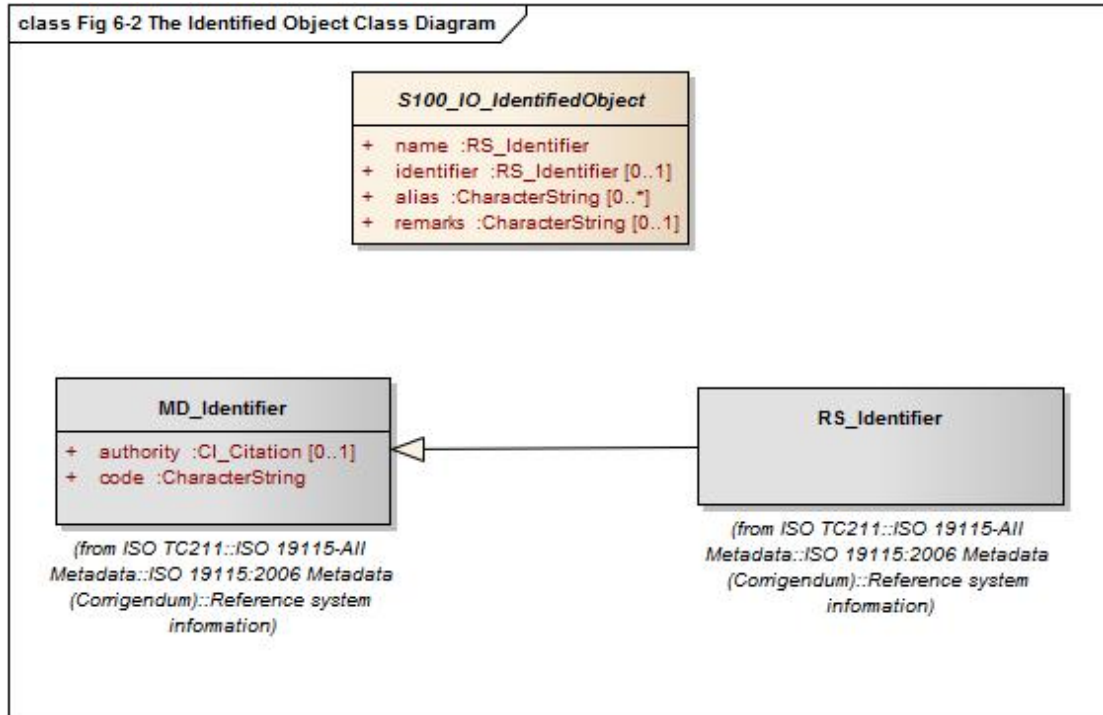
It also assures that each element can be uniquely named to identify it in a data set or software application. To facilitate the work with class names, every package shall use a prefix for its classes and data types. The Table 6-1 below shows the prefixes for various packages:

**Table 6-1 — Package prefixes**

Package name	Prefix
Identified Objects	IO
Coordinate Reference Systems	SC
Coordinate Systems	CS
Datums	CD
Coordinate Operations	CC

### 6-4 Package details

#### 6-4.1 The Identified Object package



**Figure 6-2 — The Identified Object class diagram**

NOTE If a class diagram of a package shows classes or types of another package it will be shown with a grey background. In this case not all details of this class are shown; the full details are described in the class diagram of the package where the class belongs.

#### 6-4.1.1 S100\_IO\_IdentifiedObject

Each class in this part is intended to have a mechanism to be identifiable and/or to identify an external source that is derived from the class S100\_IO\_IdentifiedObject.

Different from ISO 19111 this class is not derived from an external document but uses members defined by external standards. In addition, no other class in this part is derived from external standards. Where in ISO 19111 those classes inherit essential members, those members will be introduced here in the appropriate package diagram. This should improve the readability of this component and also avoids multiple inheritance where it is not absolutely needed.

#### 6-4.1.2 Class details

**Table 6-2 — Properties of the class IO\_IdentifiedObject**

Name	Type	Card.	Description
name	RS_Identifier	1	The primary name by which the object can be identified
identifier	RS_Identifier	0..1	An identifier that references the (external) definition of the object
alias	GenericName	0..*	An alternative name of the object
remarks	CharacterString	0..1	Comments on or information about the object

The type RS\_Identifier (from ISO 19115) has three parts:

- 1) authority : CI\_Citation [0..1]

- 2) code : CharacterString
- 3) codeSpace: CharacterString [0..1]version: CharacterString [0..1]

The type CI\_Citation is also defined in ISO 19115, for more details refer there.

## 6-4.2 The Coordinate Reference Systems package

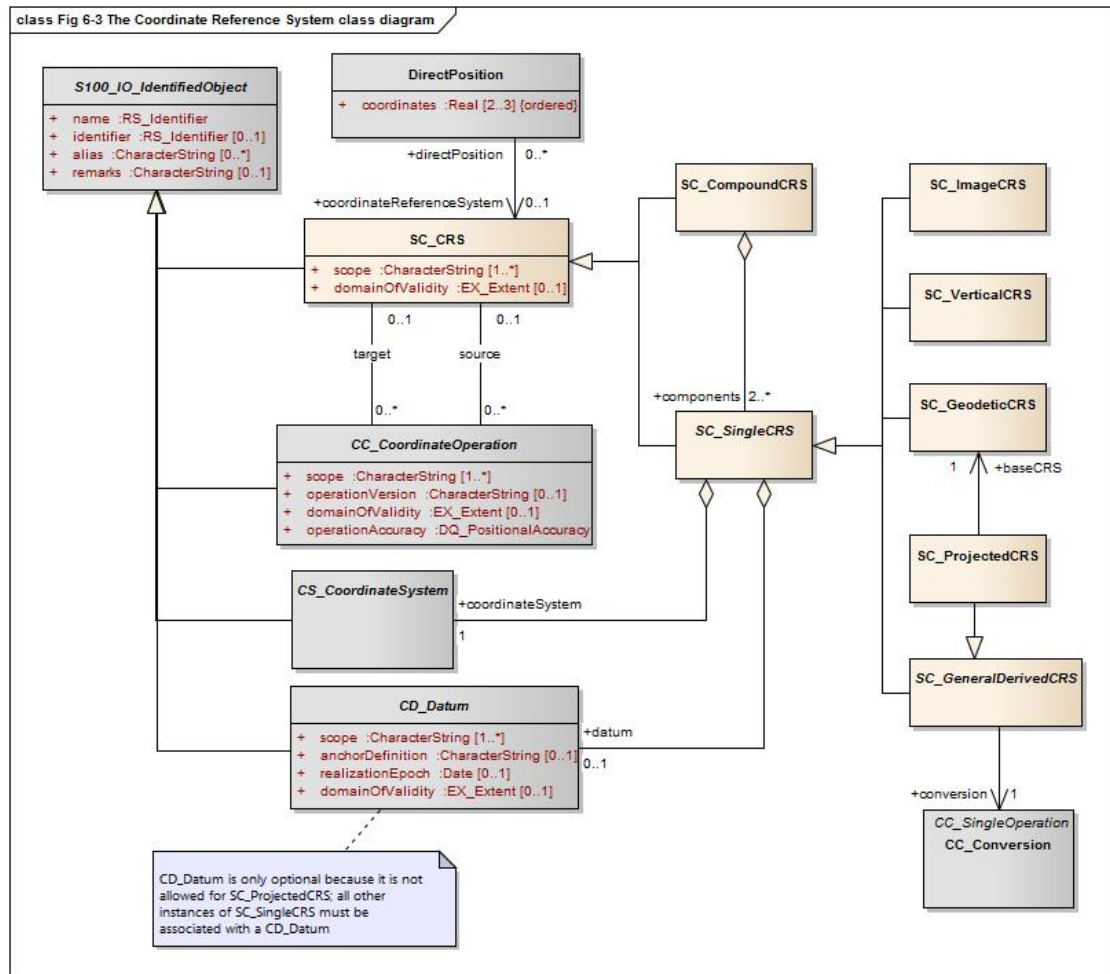


Figure 6-3 — The Coordinate Reference Systems class diagram

This package describes the base class used for all coordinate reference systems and all derived subclasses supported by this component. The diagram also shows the relation to classes in other packages.

A coordinate reference system is a coordinate system that is related to the real world by a datum. Generally, the real world will be the Earth although the principles are not restricted to the Earth. A coordinate reference system (CRS) is either a single CRS or a compound CRS.

### 6-4.3 Single CRS

A single CRS is defined by a coordinate system and an associated datum. The following types of single CRSs are supported by S-100:

- 1) Geodetic CRS
- 2) Projected CRS
- 3) Vertical CRS

#### 4) ImageCRS

A geodetic CRS is associated with a geodetic datum. It usually uses an ellipsoidal coordinate system (geodetic latitude, geodetic longitude and ellipsoidal height if 3D). A geodetic CRS can also use a Cartesian coordinate system (3D, fixed to the earth). Coordinates referenced to a Cartesian system are rarely used in data sets but are used as intermediate coordinates during certain coordinate transformations.

A projected CRS is a derived CRS with a geodetic CRS as its base and using a map projection for coordinate conversion. The underlying coordinate system is always a Cartesian coordinate system. Projected CRS are frequently used for national coordinate systems.

A vertical CRS is a 1D CRS for reporting depth or heights and associated with a vertical datum. The ellipsoidal height cannot be captured with a vertical CRS. Ellipsoidal heights are an integral part of a 3D coordinate tuple of a geodetic CRS and cannot exist independently.

An image CRS is associated with an image datum that describes how the image coordinate system is related to the image. This relation is independent of whether or not the image is georeferenced. Georeferencing is performed through a transformation of the image CRS to a geodetic or a projected CRS.

#### 6-4.3.1 Compound CRS

A compound CRS is a combination of two or more single CRSs although the use of more than two components is very unlikely. The components of a compound CRS must be independent. Two CRSs are independent if coordinates conforming to them cannot be changed from one CRS to the other by some coordinate operation. A horizontal and vertical CRS, for example, are independent while two vertical CRSs are not. Nesting of compound CRSs is not permitted, i.e. all components must be single CRSs.

Each position in a data set, given with the class `DirectPosition`, must be bound to a CRS. If in a data set different vertical datums are used for each, a vertical coordinate system has to be defined. Those vertical coordinate systems can then be used as a component in a compound coordinate system to describe a three-dimensional coordinate.

If a data product specification allows a choice of geodetic datums, even if only one is allowed in a given dataset, transformation methods must be specified that enable the datasets to be used together in an application.

#### 6-4.3.2 Class details

**Table 6-3 — Properties of the class `SC_CRS`**

Name	Type	Card.	Description
scope	CharacterString	1..*	Description of usage, or limitations of usage, for which this CRS is valid.
domainOfValidity	EX_Extend	0..1	Area or region in which this CRS is valid

**Table 6-4 — Properties of the class `SC_SingleCRS`**

Name	Type	Card.	Description
datum	CD_Datum	0..1	The datum with which the CRS is associated. The datum must be of an appropriate type (vertical or horizontal) for the CRS. Mandatory except for projected CRS, for which it must not be specified – the projected CRS uses the datum of its base CRS
coordinateSystem	CS_CoordinateSystem	1	Coordinate system used by the CRS

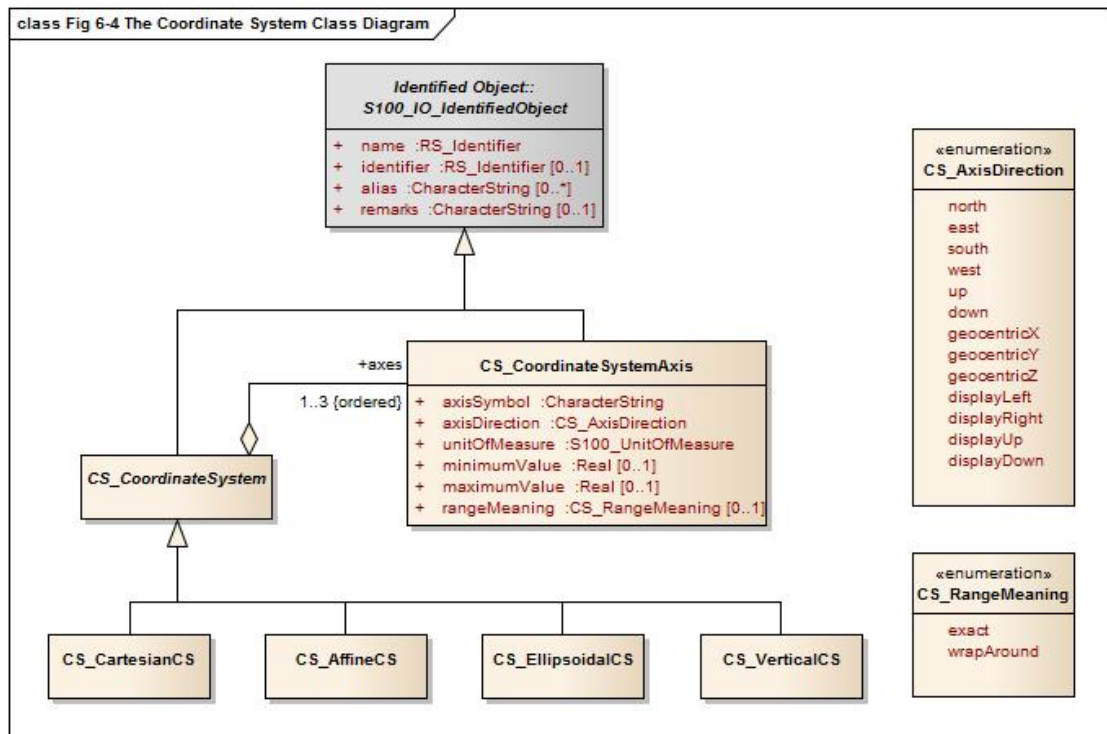
**Table 6-5 — Properties of the class SC\_GeneralDerivedCRS**

Name	Type	Card.	Description
conversion	CC_Operation	1	The coordinate conversion method to convert the coordinates from the base to the derived CRS (e.g. a map projection)

**Table 6-6 — Properties of the class SC\_Projecte d CRS**

Name	Type	Card.	Description
baseCRS	SC_GeodeticCRS	1	The geodetic CRS on which the CRS is based. In particular the datum of the base CRS is also used for the derived CRS.

**6-4.4 The Coordinate System package**



**Figure 6.4 — The "Coordinate System" class diagram**

A coordinate system comprises a non-repeating, ordered sequence of coordinate axes. The number of axes shall be equal to the number of dimensions of the space which geometry the CRS describes. The order of the coordinate axes is identical to the order of the coordinates in each coordinate tuple described by a CRS using this coordinate system.

This component defines four types of coordinate systems.

- 1) Cartesian coordinate system
- 2) Affine coordinate system
- 3) Ellipsoidal coordinate system
- 4) Vertical coordinate system

Each axis is defined by the direction, the value range and the unit of measure used.

A Cartesian coordinate system is a two- or three-dimensional coordinate system with orthogonal straight axes. All axes shall have the same length unit.

An affine coordinate system is a two- or three-dimensional coordinate system with straight axes that are not necessarily orthogonal. All axes shall have the same length unit.

An ellipsoidal coordinate system is a two- or three-dimensional coordinate system which describes coordinates on or nearby the surface of an ellipsoid. The coordinates are: geodetic latitude, geodetic longitude and (in the three-dimensional case) ellipsoidal height.

The geodetic latitude is the angle from the equatorial plane to the perpendicular to the ellipsoid through a given point, northwards treated as positive.

The geodetic longitude is the angle from the prime meridian plane to the meridian plane of a given point, eastward treated as positive.

The ellipsoidal height is the distance of a point from the ellipsoid measured along the perpendicular from the ellipsoid to this point, positive if upwards or outside of the ellipsoid.

A vertical coordinate system is a one-dimensional coordinate system used to record the heights or depths of points. Such a coordinate system is usually dependent on the Earth's gravity field. The following table specifies the type of CRS's that can use the specific type of coordinate system.

**Table 6-7 — Coordinate systems used for different CRS's**

Coordinate Reference System	Coordinate System	Dimension
Geodetic CRS	Ellipsoidal coordinate system	2, 3
	Cartesian coordinate system	3
Projected CRS	Cartesian coordinate system	2
Vertical CRS	Vertical coordinate system	1
Image CRS	Cartesian coordinate system	2
	Affine coordinate system	2

#### 6-4.4.1 Class details

**Table 6-8 — Properties of the class CS\_CoordinateSystem**

Name	Type	Card.	Description
axes	CS_CoordinateSystemAxis	1..3	The axes of the coordinate system. The order is the same as the order of the coordinates in the corresponding positions. The number equals the dimension of the space for which the coordinate system describes the geometry.

**Table 6-9 — Properties of the class CS\_CoordinateSystemAxis**

Name	Type	Card.	Description
axisSymbol	CharacterString	1	Abbreviation used for this coordinate system axis.
axisDirection	CS_AxisDirection	1	Direction of the coordinate system axis. For an Earth-fixed coordinate system the value is often approximate and intended to provide a human interpretable meaning to the axis.
minimumValue	double	0..1	The minimum value allowed for this axis in the axis' units of measure
maximumValue	double	0..1	The maximum value allowed for this axis in the axis' units of measure
rangeMeaning	CS_RangeMeaning	0..1	The meaning of the value range.
unit of measure	S100UnitOfMeasure	1	The unit of measure for this axis

**Table 6-10— Definitions of the enumeration type CS\_AxisOrentation**

Name	Description
north	Axis positive direction is north. In a geodetic or projected CRS, north is defined through the geodetic datum.
east	Axis positive direction is 90° ( $\pi/2$ radians) clockwise from north.
south	Axis positive direction is 180° ( $\pi$ radians) clockwise from north.
west	Axis positive direction is 270° ( $3\pi/2$ radians) clockwise from north.
up	Axis positive direction is up relative to gravity.
down	Axis positive direction is down relative to gravity.
geocentricX	Axis positive direction is in the equatorial plane from the centre of the modelled earth towards the intersection of the equator with the prime meridian.
geocentricY	Axis positive direction is in the equatorial plane from the centre of the modelled earth towards the intersection of the equator and the meridian $\pi/2$ radians eastwards from the prime meridian.
geocentricZ	Axis positive direction is from the centre of the modelled earth parallel to its rotation axis and towards its north pole.
displayLeft	Axis positive direction is left in display.
displayRight	Axis positive direction is right in display.
displayUp	Axis positive direction is up in display.
displayDown	Axis positive direction is down in display.

**Table 6-11 — Definitions of the enumeration type CS\_RangeMeaning**

Name	Description
exact	Any value between and including minValue and maxValue is valid.
wrapAround	The axis is continuous with values wrapping around at the minValue and maxValue. Values with the same meaning repeat modulo ( $\text{maxValue} - \text{minValue}$ ). An example for this is the geodetic longitude; the axis is defined as a circle and the values wrap around $\pm\pi$ ( $\pm 180^\circ$ )



## 6-4.5 The Datum package

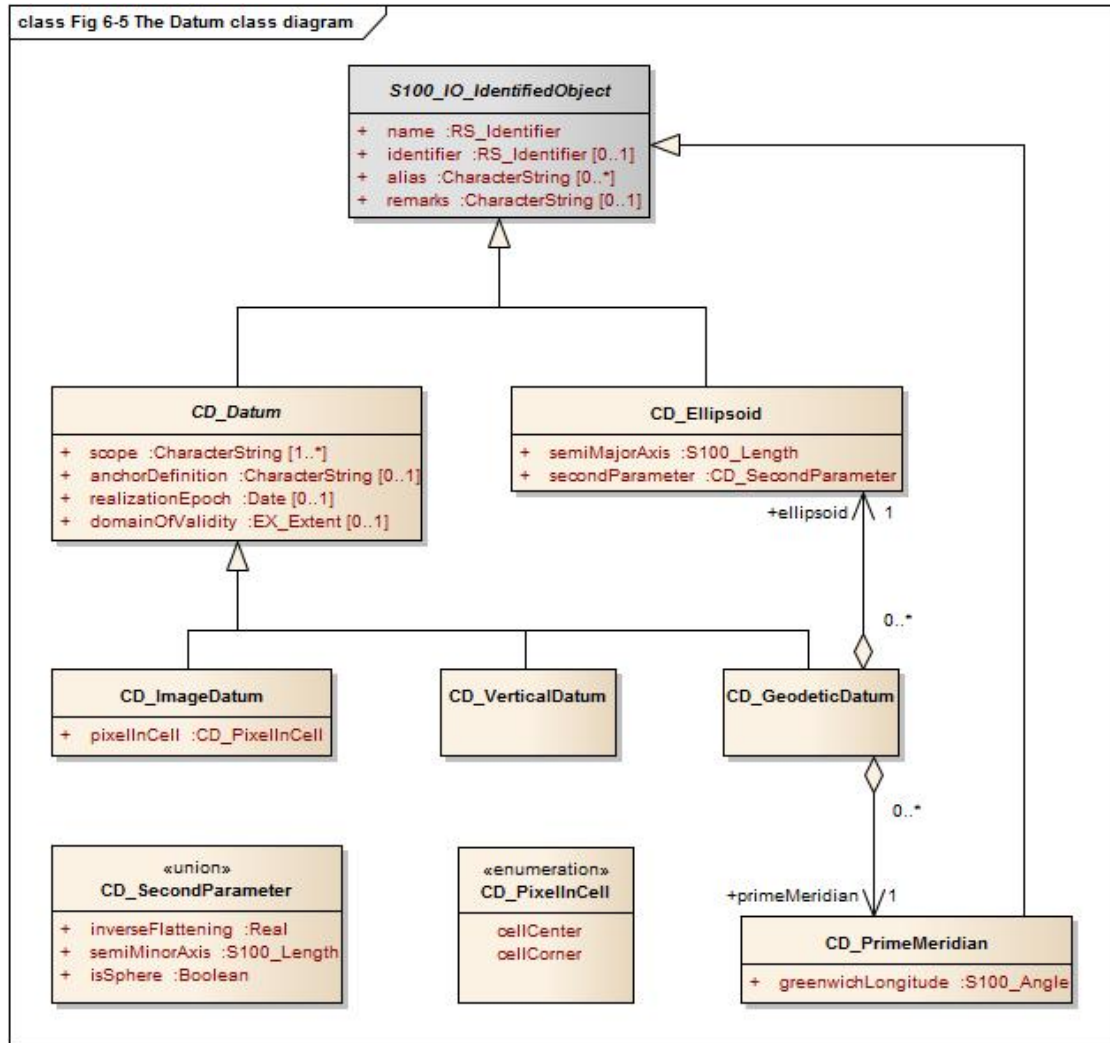


Figure 6.5 — The Datum class diagram

A datum is a parameter or set of parameters that defines the position of the origin, the scale, and the orientation of a coordinate system. Three types of datums are described by S-100.

- 1) A geodetic datum
- 2) A vertical datum
- 3) An image datum

A geodetic datum fixes the relationship of a two- or three-dimensional coordinate system to the Earth. This is done by means of an ellipsoid as the model of the Earth and of a prime meridian as the point of origin of geodetic longitude.

A vertical datum fixes the relationship between gravity-related heights or depths to the Earth. It is used to reference a vertical coordinate system. This relationship may be quite complex.

Ellipsoidal heights are treated as related to a three-dimensional ellipsoidal coordinate system referenced to a geodetic datum. They cannot be referenced by a vertical datum.

An image datum fixes the relationship between a coordinate system and an image. This is independent of whether the image is geo-referenced or not. An image CS is for locating a position within the image, not the position of the object in the real world

An ellipsoid in general is a quadratic surface given in Cartesian coordinates by:

$$\frac{x^2}{a^2} + \frac{y^2}{b^2} + \frac{z^2}{c^2} = 1$$

Where a, b, c are called semi-axes of the ellipsoid.

In the context of geodesy two semi-axes are equal ( $a=b$ ) and  $a > c$ . This figure is also called an oblate spheroid. In S-100 the term ellipsoid is used for this special case and the two semi axes are denoted semi-major axis (a) and semi-minor axis (b), with  $a > b$ .

An ellipsoid can be defined either by its two semi-axes or alternatively by its semi-major axis and the inverse flattening:  $f^{-1} = \frac{a}{a-b}$

If both semi-axes are equal the ellipsoid is a sphere. In this case the inverse flattening is not defined. (The flattening is 0).

To define the origin on the (circular) axis for the geodetic longitude the prime meridian is used. It is the meridian from which the longitudes of other meridians are quantified.

#### 6-4.5.1 Class details

**Table 6-12 — Properties of the class CD\_Datum**

Name	Type	Card.	Description
scope	CharacterString	1..*	Description of usage, or limitations of usage, for which this datum is valid.
anchorDefinition	CharacterString	0..1	A description, possibly including coordinates of an identified point or points, of the relationship used to anchor the coordinate system to the Earth or alternate object. For a geodetic datum this is known as the fundamental point. For an image datum it is usually a corner of the image or its centre.
realizationEpoch	Date	0..1	The time after which this datum definition is valid.
domainOfValidity	EX_Extent	0..1	Area or region in which this datum is valid.

**Table 6-13— Properties of the class CD\_Ellipsoid**

Name	Type	Card.	Description
semiMajorAxis	Length	1	The length of the semi-major axis of the ellipsoid
secondParameter	CD_SecondParameter	1	The second parameter to define the ellipsoid, either the length of the semi-minor axis or the inverse flattening of the ellipsoid.

**Table 6-14 — Properties of the union CD\_SecondParameter**

Name	Type	Card.	Description
inverseFlattening	double	0..1	the inverse flattening of the ellipsoid: $f^{-1} = \frac{a}{a-b}$
semiMinorAxis	Length	0..1	The length of the semi-minor axis of the ellipsoid
isSphere	boolean	0..1	true if the ellipsoid is a sphere

<sup>1</sup> Exactly one member must be defined

**Table 6-15 — Properties of the class CD\_PrimeMeridian**

Name	Type	Card.	Description
greenwichLongitude	Angle	1	Longitude of the prime meridian measured from the Greenwich meridian, positive eastward.

**Table 6-16 — Properties of the class CD\_GeodeticDatum**

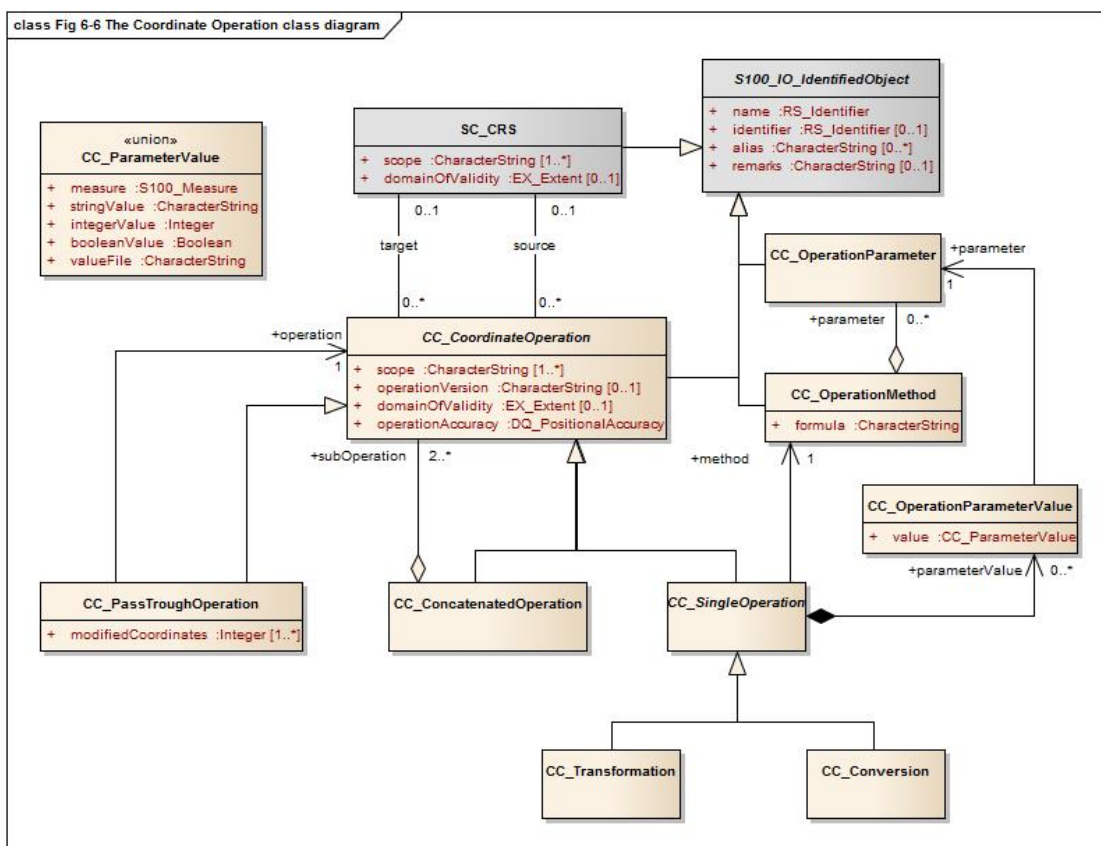
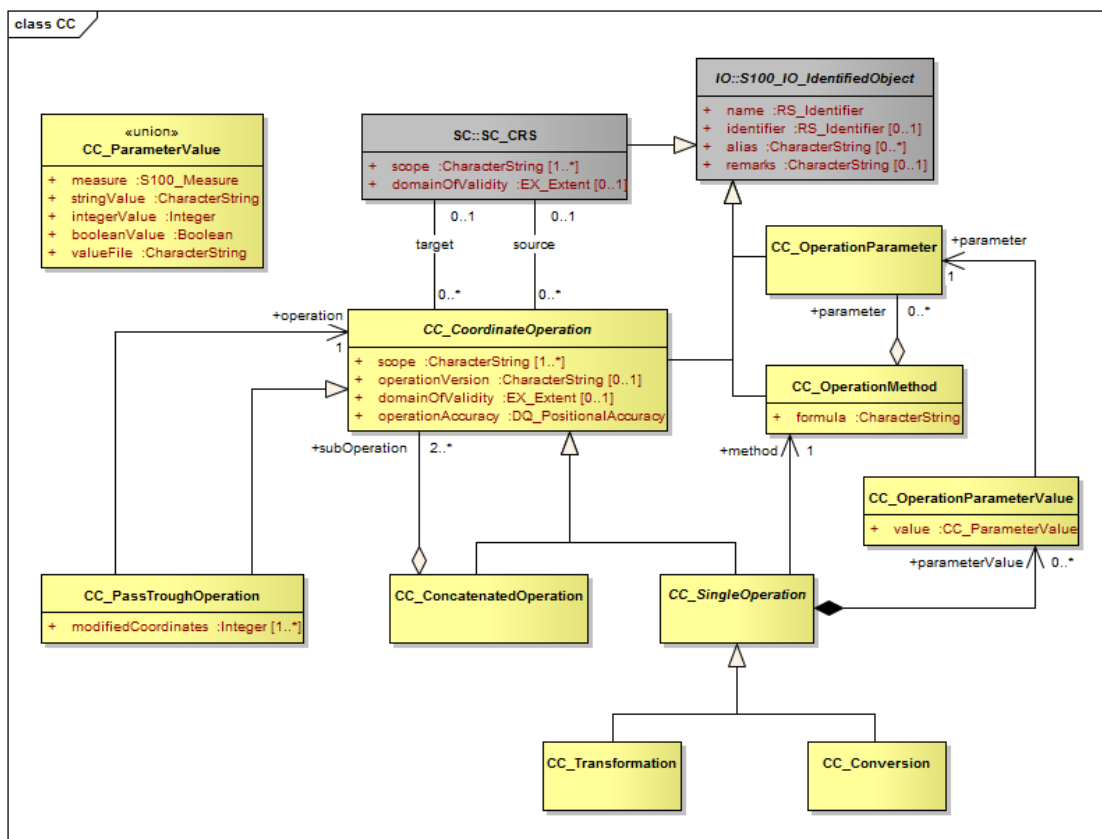
Name	Type	Card.	Description
Ellipsoid	CD_Ellipsoid	1	The ellipsoid used as a model of the Earth for this datum
primeMeridian	CD_PrimeMeridian	1	The prime meridian of this datum

**Table 6-17 — Properties of the class CD\_ImageDatum**

Name	Type	Card.	Description
pixellnCell	CD_PixellnCell	1	Specification of the way the image grid is associated with the image data attributes.

**Table 6-18 — Definitions of the enumeration CD\_PixellnCell**

Name	Description
cellCenter	The origin of the image coordinate system is the centre of a grid cell or image pixel.
cellCorner	The origin of the image coordinate system is the corner of a grid cell, or half-way between the centres of adjacent image pixels.



6-4.6 The Coordinate Operation package

### Figure 6.6 — The Coordinate Operation class diagram

Coordinate operations convert coordinates which refer to one coordinate reference system to coordinates that refer to another coordinate reference system. Therefore each coordinate operation has a source CRS and a target CRS.

The following types of coordinate operations are defined by S-100:

- 1) Coordinate Transformation
- 2) Coordinate Conversion
- 3) Pass Through Operation
- 4) Concatenated Coordinate Operation

A coordinate transformation changes coordinates from a coordinate reference system based on one datum to a coordinate reference system based on a second datum. The parameters of these operations are usually derived empirically. The stochastic nature of the parameters may result in several different versions of the same coordinate transformation. Therefore multiple coordinate transformations may exist for a given pair of coordinate reference systems, differing in their method, parameter values and accuracy characteristics.

A coordinate conversion changes coordinates between two coordinate reference systems based on the same datum. This type of coordinate operation includes map projections.

A pass through operation specifies what subset of a coordinate tuple is subject to a requested coordinate operation. It takes the form of referencing another coordinate operation and specifying a sequence of numbers defining the positions in the coordinate tuple of the coordinates affected by that coordinate operation.

**EXAMPLE** For a coordinate operation on the height coordinate of a tuple defined by a compound reference system the pass through operation filters the height coordinate prior to passing it to the relevant coordinate operation.

A concatenated coordinate operation is a non-repeating sequence of coordinate operations. This sequence of coordinate operations is constrained by the requirement that the target coordinate reference system of each step shall be the same as the source coordinate reference system of the next step. The source coordinate reference system of the first step and the target coordinate reference system of the last step are the source and target coordinate reference systems specified for the concatenated coordinate operation. Concatenated coordinate operation may contain coordinate conversions and coordinate transformations. If the datums of the source and target coordinate reference system are different the entire operation is a coordinate transformation.

An example of concatenation is the “Position vector 7-parameter transformation” (EPSG 9606), which is internally a concatenation of

- 1) A “Geographic/Geocentric conversion” (EPSG9602)
- 2) A Helmert transformation on the geocentric coordinates
- 3) The inverse case of the “Geographical/Geocentric conversion”

Although the first and the last step are conversions that are not changing the datum, the second step does, and therefore the entire operation is a transformation.

Coordinate transformation and conversions are single coordinate operations that use similar mathematical concepts. Those concepts (algorithms or procedures) are defined by an operation method. Each operation method is fully defined by a mathematical formula and a set of parameters, although this set may be empty.

The mathematical formulas for an operation are specified in text form or by referencing a source document.

Each instance of a single coordinate operation defines a value for each parameter of the corresponding operation method. Parameters and methods are identifiable objects and may be defined by referencing.

#### 6-4.6.1 Class details

**Table 6-19— Properties of the class CC\_CoordinateOperation**

Name	Type	Card.	Description
scope	CharacterString	1..*	Description of usage, or limitations of usage, for which this coordinate operation is valid.
operationVersion	CharacterString	0..1	Version of the coordinate transformation. Mandatory when describing a coordinate transformation, and should not be supplied for a coordinate conversion.
domainOfValidity	EX_Extent	0..1	Area or region in which this coordinate operation is valid.
operationAccuracy	DQ_PositionalAccuracy	0..1	Estimate of the impact of this coordinate operation on point accuracy.

**Table 6-20 — Properties of the class CC\_SingleOperation**

Name	Type	Card.	Description
method	CC_OperationMethod	1	The method (algorithm or procedure) used to perform the coordinate operation.
parameterValue	CC_OperationParameterValue	0..*	A value for each parameter of the associated method.

**Table 6-21 — Properties of the class CC\_ConcatenatedOperation**

Name	Type	Card.	Description
subOperation	CC_CoordinateOperation	2..*	The ordered sequence of operations that are concatenated.

**Table 6-22 — Properties of the class CC\_PassThroughOperation**

Name	Type	Card.	Description
modifiedCoordinate	integer	1..*	Ordered sequence of positive integers defining the positions in a coordinate tuple of the coordinates affected by this pass-through operation.
operation	CC_CoordinateOperation	1	The coordinate operation for which this pass through operation specifies the subset of coordinates.

**Table 6-23 — Properties of the class CC\_OperationMethod**

Name	Type	Card.	Description
formula	CharacterString	1	Formula(s) or procedure used by this operation method.
parameter	CC_OperationParameter	0..*	A set of parameters used by this coordinate operation method.

**Table 6-24 — Properties of the class CC\_OperationParameterValue**

Name	Type	Card.	Description
value	CC_ParameterValue	1	Value of the coordinate operation parameter value. Most parameter values are numeric, but other types of

			parameter values are possible.
parameter	CC_OperationParameter	1	Parameter for which the value is defined.

**Table 6-25 — Properties of the union CC\_ParameterValue**

Name	Type	Card.	Description
measure	S100_Measure	0..12	A numeric value of the coordinate operation parameter with its associated unit of measure.
stringValue	CharacterString	0..1	A string value of the coordinate operation parameter.
integerValue	integer	0..1	An integer value of the coordinate operation parameter. Usually used for a count or index.
booleanValue	boolean	0..1	A Boolean value of the coordinate operation parameter.
valueFile	CharacterString	0..1	Reference to a file containing one or more parameter values. This can be a filename or an URL or some other method to reference a file.

---

2 Exactly one member must be defined

## Appendix 6-A

### Examples (informative)

Four examples are shown in this Appendix to demonstrate the use of the required information to describe a coordinate reference system.

1. 2D geodetic CRS using references to an external source
2. Projected CRS using references to an external source
3. The same CRS defining all details in place
4. A compound CRS combining the first example with a vertical CRS

An XML like notation is used for the examples. UML identifiers are used as element names. Values are shown in **bold**. For a better overview, data types may be included in the element's name and shown in [blue](#).

#### 6-A-1. 2D geodetic CRS using references to an external source

This example uses a reference to the EPSG Geodetic Parameter Data Set. Please note that the class SC\_CRS is used for the referencing and all details are defined in the referenced source. An exception is the scope since this is a mandatory field in the class SC\_CRS.

```
<SC_CRS:example1>
  <RS_Identifier:name>
    <code>WGS 84</code>
  </RS_Identifier:name>
  <RS_Identifier:identifier>
    <CI_Citation:authority>
      <title>EPSG Geodetic Parameter Data Set</title>
      <edition>6.5</edition>
      <CI_Date:date>
        <date>20040113</date>
        <dateType>revision</dateType>
      </CI_Date:date>
    </CI_Citation:authority>
    <code>4326</code>
  </RS_Identifier:identifier>
  <scope>
    Horizontal component of the 3D geodetic CRS used by the GPS satellite system.
  </scope>
</SC_CRS:example1>
```

#### 6-A-2. Projected CRS using references to an external source

This example is similar to A.2. It defines a projected CRS by referencing the EPSG Geodetic Parameter Data Set.

```
<SC_CRS:example2>
  <RS_Identifier:name>
    <code>Amersfoort / RD new</code>
  </RS_Identifier:name>
  <RS_Identifier:identifier>
    <CI_Citation:authority>
      <title>EPSG Geodetic Parameter Data Set</title>
      <edition>6.5</edition>
      <CI_Date:date>
        <date>20040113</date>
        <dateType>revision</dateType>
      </CI_Date:date>
    </CI_Citation:authority>
```



```

    <code>28992</code>
  </RS_Identifier:identifier>
</scope>
  Large and medium scale topographic mapping and engineering survey.
</scope>
</SC_CRS:example2>

```

### 6-A-3. Projected CRS defining all details

This example is the full detail of A.3:

```

<SC_ProjectedCRS:example3>
  <!-- name and scope -->
  <RS_Identifier:name>
    <code>Amersfoort / RD new</code>
  </RS_Identifier:name>
</scope>
  Large and medium scale topographic mapping and engineering survey.
</scope>

```

```

  <!-- the coordinate system -->
  <CS_CartesianCS:coordinateSystem>
    <!-- axis # 1 -->
    <CS_CoordinateSystemAxis:axis>
      <RS_Identifier:name>
        <code>Easting</code>
      </RS_Identifier:name>
      <axisSymbol>X</axisSymbol>
      <axisDirection>east</axisDirection>
      <CS_UnitOfMeasure:unitOfMeasure>
        <RS_Identifier:name>
          <code>Metre</code>
        </RS_Identifier:name>
        <symbol>m</symbol>
        <type>length</type>
      </CS_UnitOfMeasure:unitOfMeasure>
    </CS_CoordinateSystemAxis:axis>
    <!-- axis # 2 -->
    <CS_CoordinateSystemAxis:axis>
      <RS_Identifier:name>
        <code>Northing</code>
      </RS_Identifier:name>
      <axisSymbol>Y</axisSymbol>
      <axisDirection>north</axisDirection>
      <CS_UnitOfMeasure:unitOfMeasure>
        <RS_Identifier:name>
          <code>Metre</code>
        </RS_Identifier:name>
        <symbol>m</symbol>
        <type>length</type>
      </CS_UnitOfMeasure:unitOfMeasure>
    </CS_CoordinateSystemAxis:axis>
  </CS_CartesianCS:coordinateSystem>
  <!-- end of the coordinate system -->

  <!-- the coordinate conversion -->
  <CC_Conversion:conversion>

```

```

    <RS_Identifier:name>
      <code>RD New</code>
    </RS_Identifier:name>
  <scope>
    Large and medium scale topographic mapping and engineering
    survey.
  </scope>
  <!-- the operation method including the list of parameters -->
  <CC_OperationMethod:method>
    <RS_Identifier:name>
      <code>Oblique Stereographic</code>
    </RS_Identifier:name>
    <formula>See EPSG guidance No. 7</formula>
    <CC_OperationParameter:parameter>
      <RS_Identifier:name>
        <code>Latitude of natural origin</code>
      </RS_Identifier:name>
    </CC_OperationParameter:parameter>
    <CC_OperationParameter:parameter>
      <RS_Identifier:name>
        <code>Longitude of natural origin</code>
      </RS_Identifier:name>
    </CC_OperationParameter:parameter>
    <CC_OperationParameter:parameter>
      <RS_Identifier:name>
        <code>Scale factor at natural origin</code>
      </RS_Identifier:name>
    </CC_OperationParameter:parameter>
    <CC_OperationParameter:parameter>
      <RS_Identifier:name>
        <code>False easting</code>
      </RS_Identifier:name>
    </CC_OperationParameter:parameter>
    <CC_OperationParameter:parameter>
      <RS_Identifier:name>
        <code>False northing</code>
      </RS_Identifier:name>
    </CC_OperationParameter:parameter>
  </CC_OperationMethod:method>
  <!-- The parameter value # 1 -->
  <CC_OperationParameterValue:parameterValue>
    <parameter>Latitude of natural origin</parameter>
    <CC_ParameterValue:value>
      <CC_Measure:measure>
        <value>52° 9' 22.1780" N</value>
        <CS_UnitOfMeasure:uom>
          <RS_Identifier:name>
            <code>Degree</code>
          </RS_Identifier:name>
          <type>angle</type>
        </CS_UnitOfMeasure:uom>
      </CC_Measure:measure>
    </CC_ParameterValue:value>
  </CC_OperationParameterValue:parameterValue>
  <!-- The parameter value # 2 -->
  <CC_OperationParameterValue:parameterValue>
    <parameter>Longitude of natural origin</parameter>

```

```

<CC_ParameterValue:value>
  <CC_Measure:measure>
    <value>5° 23' 15.5" E</value>
    <CS_UnitOfMeasure:uom>
      <RS_Identifier:name>
        <code>Degree</code>
      </RS_Identifier:name>
      <type>angle</type>
    </CS_UnitOfMeasure:uom>
  </CC_Measure:measure>
</CC_ParameterValue:value>
</CC_OperationParameterValue:parameterValue>
<!-- The parameter value # 3 -->
<CC_OperationParameterValue:parameterValue>
  <parameter>Scale factor at natural origin</parameter>
  <CC_ParameterValue:value>
    <CC_Measure:measure>
      <value>0.9999079</value>
      <CS_UnitOfMeasure:uom>
        <RS_Identifier:name>
          <code>Scale</code>
        </RS_Identifier:name>
        <type>scale</type>
      </CS_UnitOfMeasure:uom>
    </CC_Measure:measure>
  </CC_ParameterValue:value>
</CC_OperationParameterValue:parameterValue>
<!-- The parameter value # 4 -->
<CC_OperationParameterValue:parameterValue>
  <parameter>False easting</parameter>
  <CC_ParameterValue:value>
    <CC_Measure:measure>
      <value>155000</value>
      <CS_UnitOfMeasure:uom>
        <RS_Identifier:name>
          <code>Metre</code>
        </RS_Identifier:name>
        <symbol>m</symbol>
        <type>length</type>
      </CS_UnitOfMeasure:uom>
    </CC_Measure:measure>
  </CC_ParameterValue:value>
</CC_OperationParameterValue:parameterValue>
<!-- The parameter value # 5 -->
<CC_OperationParameterValue:parameterValue>
  <parameter>False northing</parameter>
  <CC_ParameterValue:value>
    <CC_Measure:measure>
      <value>463000</value>
      <CS_UnitOfMeasure:uom>
        <RS_Identifier:name>
          <code>Metre</code>
        </RS_Identifier:name>
        <symbol>m</symbol>
        <type>length</type>
      </CS_UnitOfMeasure:uom>
    </CC_Measure:measure>
  </CC_ParameterValue:value>
</CC_OperationParameterValue:parameterValue>

```

```

    </CC_ParameterValue:value>
  </CC_OperationParameterValue:parameterValue>
</CC_Conversion:conversion>
<!-- end of coordinate conversion -->

<!-- the base geodetic CRS -->
<SC_GeodeticCRS:baseCRS>
  <!-- the coordinate system of the base CRS-->
  <CS_GeodeticCS:coordinateSystem>
    <!-- axis # 1 -->
    <CS_CoordinateSystemAxis:axis>
      <RS_Identifier:name>
        <code>Latitude</code>
      </RS_Identifier:name>
      <axisSymbol>ϕ</axisSymbol>
      <axisDirection>north</axisDirection>
      <CS_UnitOfMeasure:unitOfMeasure>
        <RS_Identifier:name>
          <code>Degree</code>
        </RS_Identifier:name>
        <symbol>°</symbol>
        <type>angle</type>
      </CS_UnitOfMeasure:unitOfMeasure>
    </CS_CoordinateSystemAxis:axis>
    <!-- axis # 2 -->
    <CS_CoordinateSystemAxis:axis>
      <RS_Identifier:name>
        <code>Longitude</code>
      </RS_Identifier:name>
      <axisSymbol>λ</axisSymbol>
      <axisDirection>east</axisDirection>
      <CS_UnitOfMeasure:unitOfMeasure>
        <RS_Identifier:name>
          <code>Degree</code>
        </RS_Identifier:name>
        <symbol>°</symbol>
        <type>angle</type>
      </CS_UnitOfMeasure:unitOfMeasure>
    </CS_CoordinateSystemAxis:axis>
  </CS_GeodeticCS:coordinateSystem>
  <!-- end of coordinate system of the base CRS -->

  <!-- the geodetic datum -->
  <CD_GeodeticDatum:datum>
    <RS_Identifier:name>
      <code>Amersfoort</code>
    </RS_Identifier:name>
    <scope>
      Geodetic survey, cadastre, topographic mapping, engineering survey.
    </scope>
    <CD_Ellipsoid:ellipsoid>
      <RS_Identifier:name>
        <code>Bessel 1841</code>
      </RS_Identifier:name>
      <semiMajorAxis>6377397.155 m</semiMajorAxis>
    </CD_SecondParameter:secondParameter>
  </CD_GeodeticDatum:datum>
</SC_GeodeticCRS:baseCRS>

```

```

        <inversFlattening>299.1528128</inversFlattening>
    </CD_SecondParameter:secondParameter>
</CD_Ellipsoid:ellipsoid>
<CD_PrimeMeridian:primeMeridian>
    <RS_Identifier:name>
        <code>Greenwich</code>
    </RS_Identifier:name>
    <greenwichLongitude>0</greenwichLongitude>
</CD_PrimeMeridian:primeMeridian>
</CD_GeodeticDatum:datum>
<!-- end of the geodetic datum -->
</SC_GeodeticCRS:baseCRS>
<!-- end of base geodetic CRS -->
</SC_ProjectedCRS:example3>

```

#### 6-A-4. A compound CRS combining the first example with a vertical CRS

Here a compound CRS is defined. The horizontal component will be defined by referencing the vertical component and is defined by details (again only the vertical datum is again defined by referencing).

```

<SC_CompoundCRS:example4>
    <!-- The horizontal component -->
    <SC_CRS:component>
        <RS_Identifier:name>
            <code>WGS 84</code>
        </RS_Identifier:name>
        <RS_Identifier:identifier>
            <CI_Citation:authority>
                <title>EPSG Geodetic Parameter Data Set</title>
                <edition>6.5</edition>
                <CI_Date:date>
                    <date>20040113</date>
                    <dateType>revision</dateType>
                </CI_Date:date>
            </CI_Citation:authority>
            <code>4326</code>
        </RS_Identifier:identifier>
    </SC_CRS:component>
    <scope>
        Horizontal component of the 3D geodetic CRS used by the GPS satellite system.
    </scope>
    </SC_CRS:component>
    <!-- The vertical component -->
    <SC_VerticalCRS:component>
        <RS_Identifier:name>
            <code>Mean low water springs</code>
        </RS_Identifier:name>
        <scope>Hydrography</scope>
    </SC_VerticalCRS:component>
    <CS_VerticalCS:coordinateSystem>
        <RS_Identifier:name>
            <code>Gravity related depth</code>
        </RS_Identifier:name>
        <!-- axis # 1 -->
        <CS_CoordinateSystemAxis:axis>
            <RS_Identifier:name>
                <code>Depth</code>
            </RS_Identifier:name>
        </CS_CoordinateSystemAxis:axis>
    </CS_VerticalCS:coordinateSystem>

```

```

<axisSymbol>z</axisSymbol>
<axisDirection>down</axisDirection>
<CS_UnitOfMeasure:unitOfMeasure>
  <RS_Identifier:name>
    <code>Metre</code>
  </RS_Identifier:name>
  <symbol>m</symbol>
  <type>length</type>
</CS_UnitOfMeasure:unitOfMeasure>
</CS_CoordinateSystemAxis:axis>
<!-- The vertical datum (referenced to S-57 Attribute Catalogue) -->
<CD_VerticalDatum:datum>
  <RS_Identifier:name>
    <code>Mean low water springs</code>
  </RS_Identifier:name>
  <RS_Identifier:identifier>
    <CI_Citation:authority>
      <title>
        IHO TRANSFER STANDARD for DIGITAL
        HYDROGRAPHIC DATA - Annex A
      </title>
      <edition>3.1</edition>
      <CI_Date:date>
        <date>200011</date>
        <dateType>publication</dateType>
      </CI_Date:date>
      </CI_Citation:authority>
      <code>VERDAT 1</code>
    </RS_Identifier:identifier>
    <scope>Hydrography</scope>
  </CD_VerticalDatum:datum>
</CS_VerticalCS:coordinateSystem>
  </SCVerticalCRS:component>
</SC_CompoundCRS:example4

```

# **S-100 – Part 7**

## **Spatial Schema**

## Contents

7-1	Scope .....	1
7-2	Conformance .....	1
7-3	Normative references .....	2
7-4	Symbols, notation and abbreviated terms .....	2
7-4.1	Abbreviations .....	2
7-5	Geometry .....	3
7-5.1	Introduction .....	3
7-5.1.1	S-100 spatial schema Geometry classes and their ISO 19107 reference .....	3
7-5.1.2	DirectPosition .....	4
7-5.1.3	GM_Position .....	4
7-5.2	Simple geometry .....	4
7-5.2.1	S100_GM_CurveInterpolation .....	5
7-5.2.2	GM_CurveSegment .....	5
7-5.2.3	GM_SurfaceInterpolation .....	5
7-5.2.4	GM_SurfacePatch .....	6
7-5.2.5	GM_Polygon .....	6
7-5.2.6	GM_Curve .....	6
7-5.2.7	GM_CurveBoundary .....	6
7-5.2.8	GM_OrientableCurve .....	7
7-5.2.9	GM_OrientableSurface .....	7
7-5.2.10	GM_Point .....	7
7-5.2.11	GM_Primitive .....	7
7-5.2.12	GM_Ring .....	7
7-5.2.13	GM_Surface .....	7
7-5.2.14	GM_SurfaceBoundary .....	7
7-5.2.15	GM_Complex .....	8
7-5.2.16	GM_Composite .....	8
7-5.2.17	GM_CompositeCurve .....	8
7-5.2.18	GM_Aggregate .....	8
7-5.2.19	GM_MultiPoint .....	8
7-5.2.20	S100_ArcByCenterPoint .....	8
7-5.2.21	S100_CircleByCenterPoint .....	9
7-5.3	Geometry configurations .....	9
7-5.3.1	Level 1 – 0-, 1-Dimension (no constraints) .....	9
7-5.3.2	Level 2a – 0-, 1-Dimension .....	9
7-5.3.3	Level 2b – 0-, 1-Dimension .....	11
7-5.3.4	Level 3a – 0-, 1- and 2-Dimension .....	11
7-5.3.5	Level 3b – 0-, 1- and 2-Dimension .....	11
Appendix 7-A	Examples .....	12



## 7-1 Scope

The spatial requirements of S-100 are less comprehensive than the requirements of ISO 19107 “Geographical Information - Spatial schema” which contains all the information necessary for describing and manipulating the spatial characteristics of geographical features and on which this Part is based. Hence this Part contains only the subset of ISO 19107 classes required for S-100. This version only contains geometry, if there is a future requirement for topology then this Part will be extended to meet these requirements.

This Part specifies:

- 1) a subset of ISO 19107 classes (clause 6) which is the minimum required to support 0, 1, 2 and 2.5 dimensional spatial schemas. As such it is restricted to specifying only data and does not include operations.
- 2) additional constraints (omitted optional elements or constrained cardinalities) which are imposed on these classes by this profile.

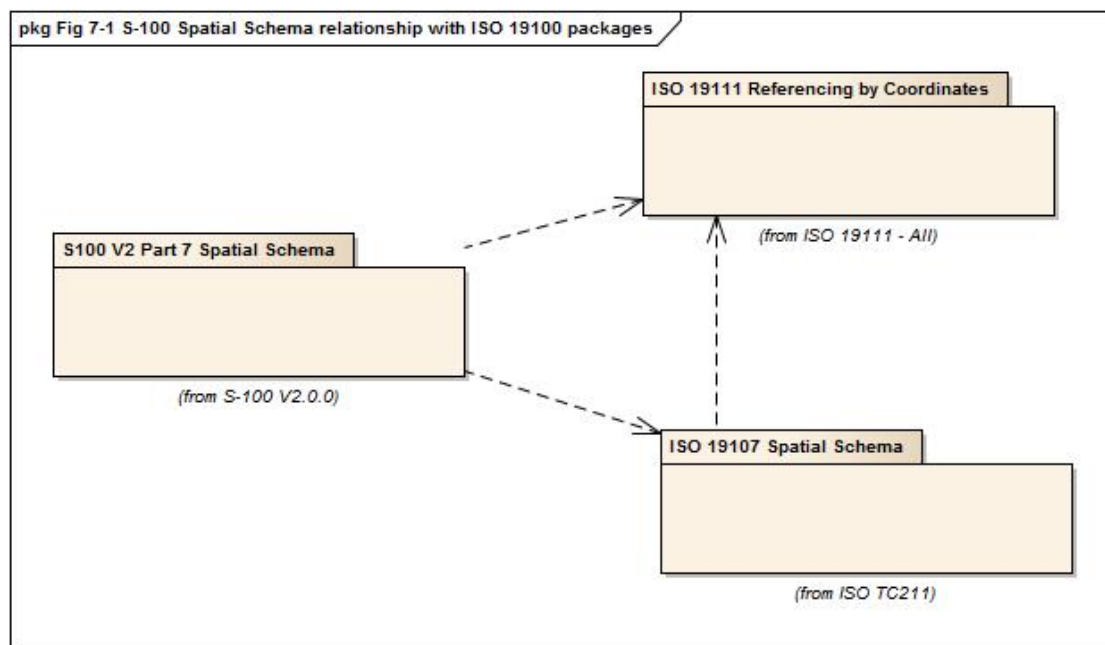


Figure 7-1 — S-100 Spatial Schema relationship with ISO 19100 Packages

## 7-2 Conformance

This profile consists of simple geometry based on three criteria – complexity, dimensionality and functional complexity. The first two criteria (complexity and dimensionality) determine the types defined in this profile that shall be implemented according to an application schema that conforms to a given conformance option.

There are:

two levels of complexity:

- 1) Geometric Primitives
- 2) Geometric Complexes,

four levels of dimensionality:

- 1) 0-dimensional objects
- 2) 0- and 1-dimensional objects
- 3) 0-, 1- and 2-dimensional objects
- 4) 0-, 1-, 2- and 2.5 -dimensional objects

and one level of functional complexity:

- 1) data types only (operations are not included).

This profile satisfies the conformance classes A.1.1.1, A.1.1.2, A.1.1.3, A.2.1.1 and A.2.1.2 in ISO 19107. This profile conforms to conformance class 2 of ISO 19106:2004.

### **7-3 Normative references**

The following referenced documents are required for the application of this document. For dated references, only the edition cited applies. For undated references, the latest edition of the referenced document (including amendments) applies.

ISO 19107 Geographic information — Spatial schema

ISO TS 19103 Geographic information — Conceptual schema language

ISO 19111 Geographic information — Spatial referencing by coordinates

### **7-4 Symbols, notation and abbreviated terms**

#### **7-4.1 Abbreviations**

OCL Object Constraint Language

2-D Two-dimensional

2.5D Two and a half dimensional

## 7-5 Geometry

### 7-5.1 Introduction

This profile consists of simple geometry which can be expressed in multiple configurations as described in ISO 19107 clause 6.1.3.

#### 7-5.1.1 S-100 spatial schema Geometry classes and their ISO 19107 reference

Table 7-1 Spatial types

Coordinate Geometry	Geometry Primitive	Geometry Complex	Geometry Aggregate
DirectPosition (6.4.1)	GM_Curve (6.3.16)	GM_Complex (6.6.2)	GM_Aggregate (6.5.2)
CurveInterpolation (6.4.8)	GM_CurveBoundary (6.3.5)	GM_Composite (6.6.3)	GM_MultiPoint (6.5.4)
GM_CurveSegment (6.4.9)	GM_OrientableCurve (6.3.14)	GM_CompositeCurve (6.6.5)	
GM_Position (6.4.5)	GM_OrientableSurface (6.3.15)		
GM_Polygon (6.4.36)	GM_Point (6.3.11)		
GM_SurfacePatch (6.4.34)	GM_Primitive (6.3.10)		
SurfaceInterpolation (6.4.32)	GM_Ring (6.3.6)		
S100_ArcByCenterPoint (none)	GM_Surface (6.3.17)		
S100_CircleByCenterPoint (none)	GM_SurfaceBoundary (6.3.7)		

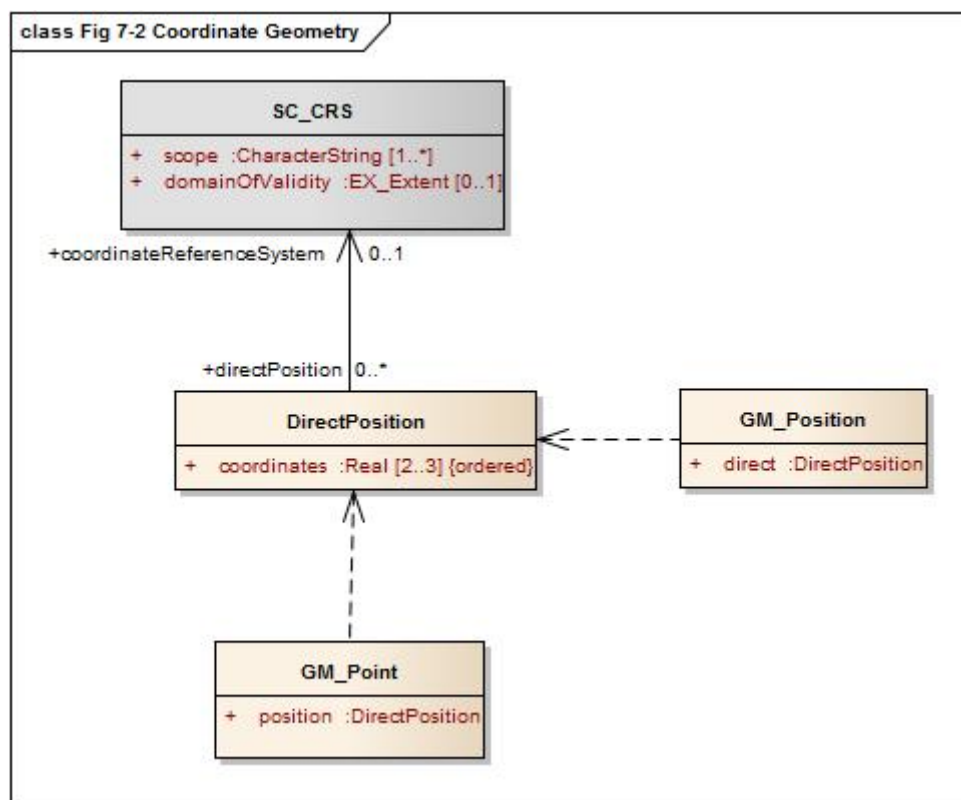


Figure 7-2 — Coordinate Geometry

### 7-5.1.2 DirectPosition

#### 7-5.1.2.1 Semantics

*DirectPosition* holds the coordinates for a position within a particular coordinate reference system. In this profile, the associated *SC\_CRS* must be linked at the *GM\_Aggregate* level and not directly to a *DirectPosition*.

### 7-5.1.3 GM\_Position

#### 7-5.1.3.1 Semantics

The data type *GM\_Position* (Figure 7-2) consists of either a *DirectPosition* or a reference to a *GM\_Point* (*GM\_PointRef*) from which a *DirectPosition* can be obtained.

This profile does not permit the use of the indirect position (*GM\_PointRef*).

## 7-5.2 Simple geometry

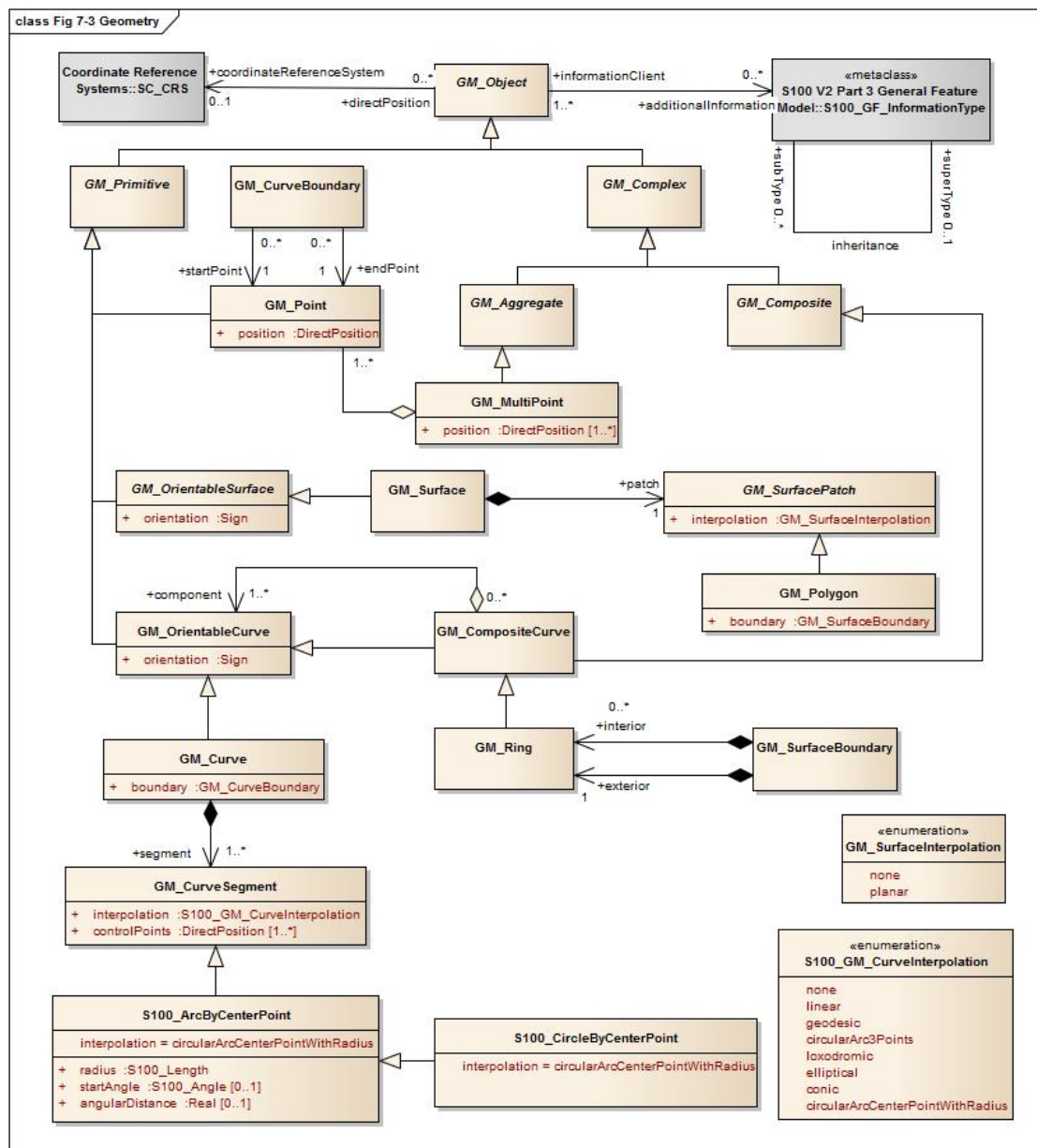


Figure 7-3 — Geometry

### 7-5.2.1 S100\_GM\_CurveInterpolation

#### 7-5.2.1.1 Semantics

*S100\_GM\_CurveInterpolation* (Figure 7-3) is a list of codes to be used to identify the interpolation mechanisms specified by an application schema.

In this profile, the types of interpolation available are limited to the following:

- 1) None (none) – the interpolation is not specified. The assumption is that the curve conforms to the spatial object type, if constrained by that (e.g., for arcs and circles) or, if not so constrained, is loxodromic.
- 2) Linear (linear) – the interpolation is defined by a series of DirectPositions on a straight line between each consecutive pair of controlPoints.
- 3) Geodesic (geodesic) – the interpolation mechanism shall return DirectPositions on a geodesic curve between each consecutive pair of controlPoints. A geodesic curve is a curve of shortest length. The geodesic shall be determined in the coordinate reference system of the *GM\_Curve* in which the *GM\_CurveSegment* is used.
- 4) Circular arc by 3 points (circularArc3Points) – the interpolation defined by a series of three DirectPositions on a circular arc passing from the start point through the middle point to the end point for each set of three consecutive controlPoints. The middle point is located halfway between the start and end point.
- 5) Loxodromic (loxodromic) – the interpolation method shall return DirectPositions on a loxodromic curve between each consecutive pair of controlPoints. A loxodrome is a line crossing all meridians at the same angle, i.e. a path of constant bearing.
- 6) Elliptical arc (elliptical): for each set of four consecutive controlPoints, the interpolation mechanism shall return DirectPositions on an elliptical arc passing from the first controlPoint through the middle controlPoints in order to the fourth controlPoint. Note: if the four controlPoints are co-linear, the arc becomes a straight line. If the four controlPoints are on the same circle, the arc becomes a circular one.
- 7) Conic arc (conic): the same as elliptical arc but using five consecutive points to determine a conic section.
- 8) Circular arc with centre and radius (circularArcCenterPointWithRadius) – the interpolation is defined by an arc of a circle of the specified radius centred at the position given by the single control point. The arc starts at the start angle parameter and extends for the angle given by the angular distance parameter. This interpolation type shall be used only with *S100\_ArcByCenterPoint* and *S100\_CircleByCenterPoint* geometry. The precise semantics of the parameters are defined in clause 7-5.2.20 (*S100\_ArcByCenterPoint*).

### 7-5.2.2 GM\_CurveSegment

#### 7-5.2.2.1 Semantics

A *GM\_CurveSegment* (Figure 7-3) defines the position, shape and orientation of a single *GM\_Curve*. A *GM\_CurveSegment* consists either of positions which are joined by straight lines, or positions which fall on a line defined by a particular type of interpolation as described in 7-5.2.1.

### 7-5.2.3 GM\_SurfaceInterpolation

#### 7-5.2.3.1 Semantics

*GM\_SurfaceInterpolation* (Figure 7-3) is a list of codes which are used to identify the method of interpolation.

In this profile, the types of *interpolation* are constrained to the following:

- 1) None (none) – the interior of the surface is not specified. The assumption is that the surface follows the reference surface defined by the coordinate reference system.
- 2) Planar (planar) – the interpolation is a section of a planar, or flat, surface. The boundary in this case shall be contained within that plane.

#### 7-5.2.4 GM\_SurfacePatch

##### 7-5.2.4.1 Semantics

The *GM\_SurfacePatch* (Figure 7-3) is the abstract root class for all 2-dimensional geometric constructs. It uses a single interpolation to define the shape and position of the associated *GM\_Surface* primitives.

#### 7-5.2.5 GM\_Polygon

##### 7-5.2.5.1 Semantics

A *GM\_Polygon* (Figure 7-3) is defined by a boundary (see 7-5.2.7 below) and an underlying surface to which this boundary is connected. The polygon uses planar interpolation. A *GM\_Polygon* is a subtype of *GM\_SurfacePatch*.

#### 7-5.2.6 GM\_Curve

##### 7-5.2.6.1 Semantics

*GM\_Curve* (Figure 7-3) is a descendent subtype of *GM\_Primitive* through *GM\_OrientablePrimitive*. It is the basis for 1-dimensional geometry. A curve is a continuous image of an open interval and so could be written as a parameterized function such as  $c(t):(a, b) \rightarrow E_n$  where "t" is a real parameter and  $E_n$  is Euclidean space of dimension n (usually 2 or 3, as determined by the coordinate reference system). Any other parameterization that results in the same image curve, traced in the same direction, such as any linear shifts and positive scales such as  $e(t) = c(a + t(b-a)):(0,1) \rightarrow E_n$ , is an equivalent representation of the same curve. For the sake of simplicity, *GM\_Curve* should be parameterized by arc length, so that the parameterization operation inherited from *GM\_GenericCurve* (see ISO 19107 clause 6.4.7) will be valid for parameters between 0 and the length of the curve.

Curves are continuous, connected, and have a measurable length in terms of the coordinate system. The orientation of the curve is determined by this parameterization, and is consistent with the tangent function, which approximates the derivative function of the parameterization and shall always point in the "forward" direction. The parameterization of the reversal of the curve defined by  $c(t):(a, b) \rightarrow E_n$  would be defined by a function of the form  $s(t) = c(a + b - t):(a, b) \rightarrow E_n$ .

A curve is composed of one or more curve segments. Each curve segment within a curve may be defined using a different interpolation method. The curve segments are connected to one another, with the end point of each segment except the last being the start point of the next segment in the segment list.

#### 7-5.2.7 GM\_CurveBoundary

##### 7-5.2.7.1 Semantics

The boundary of *GM\_Curve* shall be represented as *GM\_CurveBoundary*.

### 7-5.2.8 GM\_OrientableCurve

#### 7-5.2.8.1 Semantics

A *GM\_OrientableCurve* (Figure 7-3) is a *GM\_Curve* with an associated orientation inherited from *GM\_OrientablePrimitive*.

### 7-5.2.9 GM\_OrientableSurface

#### 7-5.2.9.1 Semantics

A *GM\_OrientableSurface* (Figure 7-3) is a *GM\_Surface* with an associated orientation inherited from its *GM\_OrientablePrimitive* parent.

### 7-5.2.10 GM\_Point

#### 7-5.2.10.1 Semantics

*GM\_Point* (Figure 7-3) is a 0-dimensional geometric primitive (*GM\_Primitive*).

*GM\_Point* is the data type for a geometric object consisting of one and only one point.

### 7-5.2.11 GM\_Primitive

#### 7-5.2.11.1 Semantics

*GM\_Primitive* (Figure 7-3) is the abstract root class for all geometric primitives defined in this profile. A *GM\_Primitive* is a *GM\_Object*. *GM\_Primitive* consists of three sub-types. *GM\_Point* which is 0-dimensional; *GM\_Curve* which is 1-dimensional and *GM\_Surface* which is 2-dimensional. All geometric primitives (*GM\_Primitive*) must be part of at least one *GM\_Aggregate* (see ISO 19107 clause 8.10.1). There is no direct link between each *GM\_Primitive* and the coordinate reference system *SC\_CRS* used for defining the position of the *GM\_Primitive*. All *GM\_Primitive* contained within a *GM\_Aggregate* use the same *SC\_CRS* for defining their position.

### 7-5.2.12 GM\_Ring

#### 7-5.2.12.1 Semantics

A *GM\_Ring* (Figure 7-3) is composed of a number of references to *GM\_OrientableCurves*. The endpoint of *GM\_OrientableCurve* "n" is the startPoint of *GM\_OrientableCurve* "n+1" and the first startpoint is coincident with the last endpoint, i.e. the *GM\_Ring* is closed. A *GM\_Ring* must be simple, i.e. it does not intersect itself.

### 7-5.2.13 GM\_Surface

#### 7-5.2.13.1 Semantics

*GM\_Surface* (Figure 7-3) is a subclass of *GM\_Primitive* and is the basis for 2-dimensional geometry. It is a *GM\_OrientableSurface* with a positive orientation.

This profile does not use instances of *GM\_Surface*. A *GM\_Surface* within this profile must be subtyped as a *GM\_Polygon*.

### 7-5.2.14 GM\_SurfaceBoundary

#### 7-5.2.14.1 Semantics

The boundary of *GM\_Surfaces* shall be represented as *GM\_SurfaceBoundary* (Figure 7-3).

A *GM\_SurfaceBoundary* consists of references to a combination of at least one exterior *GM\_Ring* and zero or more interior *GM\_Ring*. The rings must be closed as described in ISO 19107 Clause 6.6.11.1.

### 7-5.2.15 GM\_Complex

#### 7-5.2.15.1 Semantics

A *GM\_Complex* (Figure 7-3) is a collection of geometrically separate, simple *GM\_Primitive*. If a *GM\_Primitive* (other than a *GM\_Point*) is in a particular *GM\_Complex*, then there exists a set of primitives of lower dimension in the same complex that form the boundary of this primitive. For example a *GM\_Surface* is a 2 dimensional object, its boundary consists of *GM\_Curve* which are 1 dimensional.

### 7-5.2.16 GM\_Composite

#### 7-5.2.16.1 Semantics

A geometric composite, *GM\_Composite* (Figure 7-3), is a collection of primitives which must have geometry of the same type and which could exist as a single example of that primitive. For example, a composite curve is a collection of curves which could equally be represented by a single curve. This does not apply to *GM\_Point* which can only contain one point.

### 7-5.2.17 GM\_CompositeCurve

#### 7-5.2.17.1 Semantics

A *GM\_CompositeCurve* (Figure 7-3) has all the geometric properties of a curve. A composite curve is a sequence of *GM\_OrientableCurve*, each curve (except the first) begins where the previous curve ends.

### 7-5.2.18 GM\_Aggregate

#### 7-5.2.18.1 Semantics

The aggregates, *GM\_Aggregate* (Figure 7-3) gather geometric objects. Since they will often use orientation modification, the curve reference and surface references do not go directly to the *GM\_Curve* and *GM\_Surface*, but are directed to *GM\_OrientableCurve* and *GM\_OrientableSurface*.

Most geometric objects are contained in features, and cannot be held in collections that are strong aggregations. For this reason, the collections described in this clause are all weak aggregations, and shall use references to include geometric objects.

NOTE The subclasses of *GM\_OrientablePrimitive* are handled in such a manner that the reference object can link to a specific orientation of that object.

### 7-5.2.19 GM\_MultiPoint

#### 7-5.2.19.1 Semantics

*GM\_MultiPoint* is an aggregate class containing only points. The association role "element" shall be the set of *GM\_Point* contained in this *GM\_MultiPoint*.

### 7-5.2.20 S100\_ArcByCenterPoint

#### 7-5.2.20.1 Semantics

An *S100\_ArcByCenterPoint* is an arc of the circle with centre given by the single control point and radius given by the *radius* parameter. Radius is geodesic distance from the centre. The arc starts at the bearing given by the *start angle* attribute and ends at the bearing calculated by adding the value of the *angular distance* parameter to the start angle. The direction of the arc is given by the sign of the angular distance, with positive values indicating a clockwise



direction with respect to an observer located vertically above the centre point. Bearings are relative to true north except that arcs centred at either pole (where true north is undefined or ambiguous) shall use the prime meridian as the reference direction.

Start angle must be in degrees and is limited to the range [0.0, 360.0]. Angular distance must be in degrees and is limited to the range [-360.0, +360.0]. The upper bound on radius varies with location and reference geoid but shall be less than the minimum geodesic distance from the position of the centre to its antipodal point. Tools or product specifications may impose a lower limit on radius.

## 7-5.2.21 S100\_CircleByCenterPoint

### 7-5.2.21.1 Semantics

An S100\_CircleByCenterPoint is a circle with centre given by the single control point and radius given by the *radius* parameter. Start angle and angular distance may be omitted. The semantics and limits of the attributes are the same as S100\_ArcByCenterPoint with start angle assumed to be 0.0° and angular distance assumed to be +360.0° if not provided. If provided, angular distance must be +360.0 or -360.0.

## 7-5.3 Geometry configurations

Figure 7-3 depicts a one size fits all geometry model which can be further constrained in both dimensionality and complexity. This is broken down into 5 basic levels.

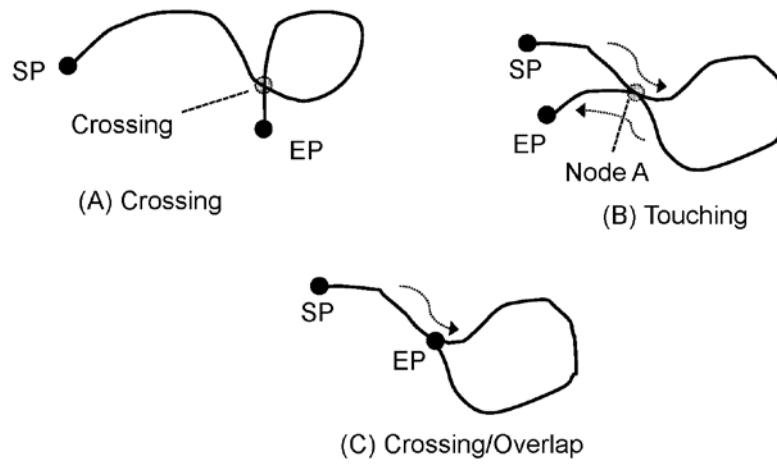
### 7-5.3.1 Level 1 – 0-, 1-Dimension (no constraints)

A set of isolated point and curve primitives. Curves do not reference points (no boundary), points and curves may be coincident. Areas are represented by a closed loop of curves.

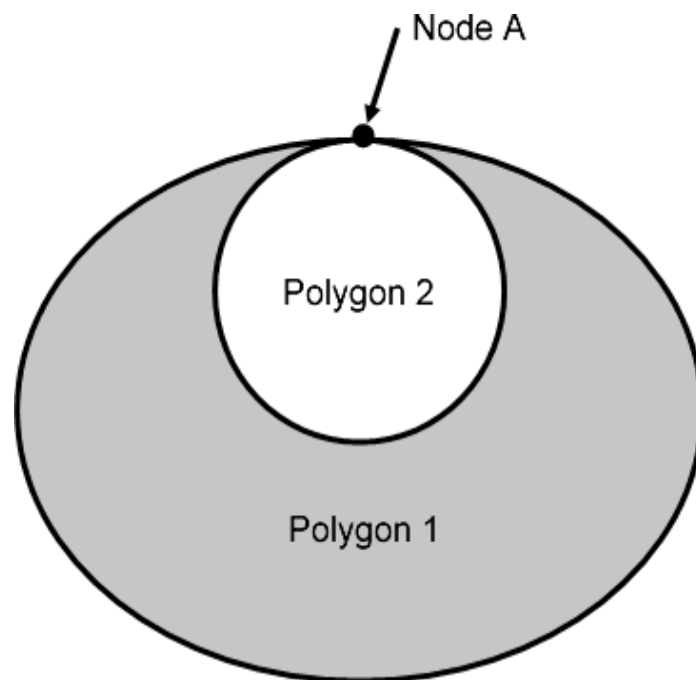
### 7-5.3.2 Level 2a – 0-, 1-Dimension

A set of point and curve primitives with the following constraints:

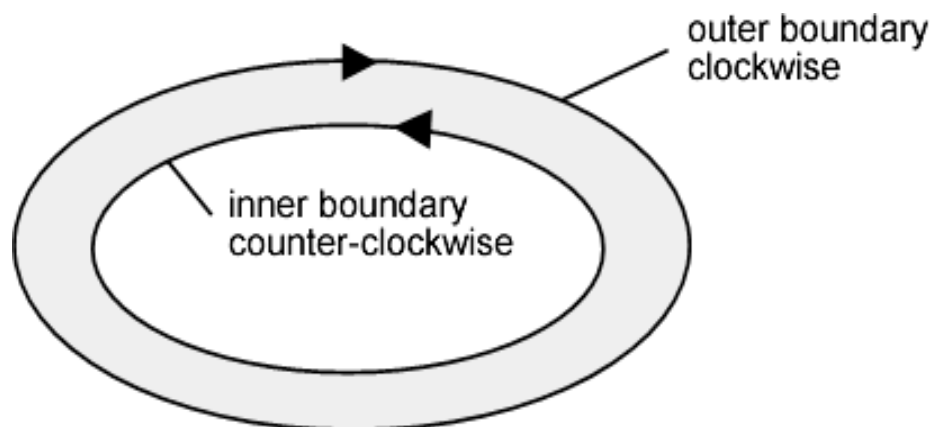
- 1) Each curve must reference a start and end point (they may be the same).
- 2) Curves must not self intersect as shown in Figure 7-4.
- 3) Areas are represented by a closed loop of curves beginning and ending at a common point.
- 4) In the case of areas with holes, all internal boundaries must be completely contained within the external boundary and the internal boundaries must not intersect each other or the external boundary. Internal boundaries may touch other internal boundaries or the external boundary tangentially (i.e. at one point) as shown in Figure 7-5.
- 5) The outer boundary of a surface must be in a clockwise direction (surface to the right of the curve) and the curve orientation positive. The inner boundary of a surface must be in a counter-clockwise direction (surface to the right of the curve) and the curve orientation negative as shown in Figure 7-6.



**Figure 7-4 Self Intersect Example (Invalid Geometries)**



**Figure 7-5 Area Holes (Valid Geometries)**



**Figure 7-6 — Boundary Direction**

### **7-5.3.3 Level 2b – 0-, 1-Dimension**

A set of point and curve primitives. The constraints for Level 2a apply plus the following:

- 1) Each set of primitives must form a geometric complex.
- 2) Curves must not intersect without referencing a point at the intersection.
- 3) Duplication of coincident geometry is prohibited.

### **7-5.3.4 Level 3a – 0-, 1- and 2-Dimension**

A set of point, curve and surface primitives. The constraints for Level 2a applies.

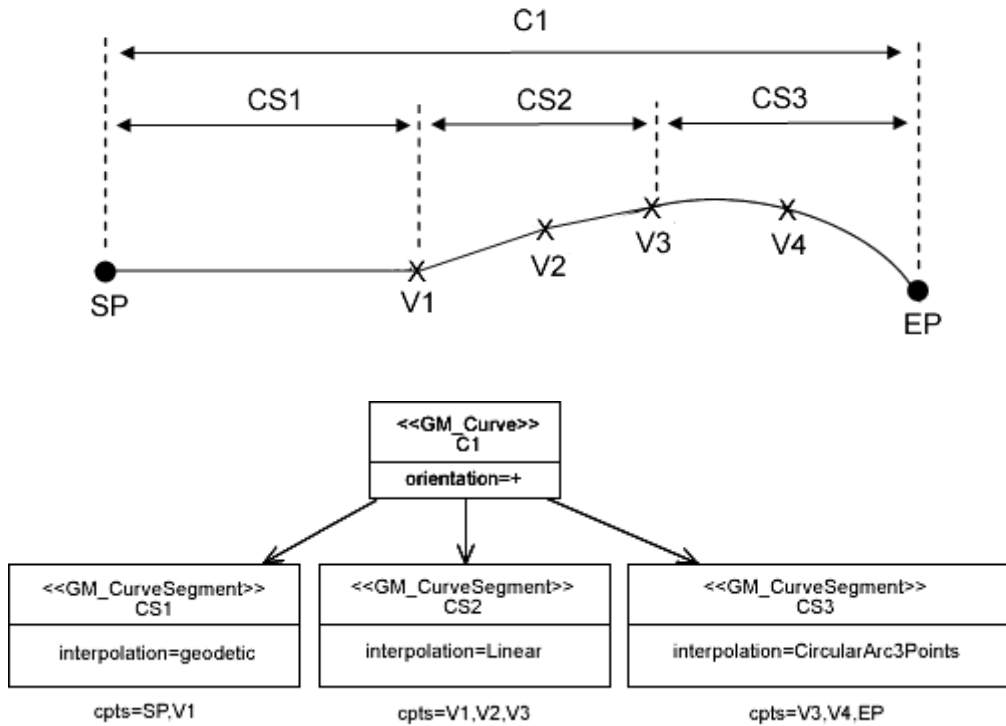
### **7-5.3.5 Level 3b – 0-, 1- and 2-Dimension**

A set of point, curve and surface primitives. The constraints for Levels 2a and 2b apply plus the following:

- 1) Surfaces must be mutually exclusive and provide exhaustive cover.

## Appendix 7-A Examples (informative)

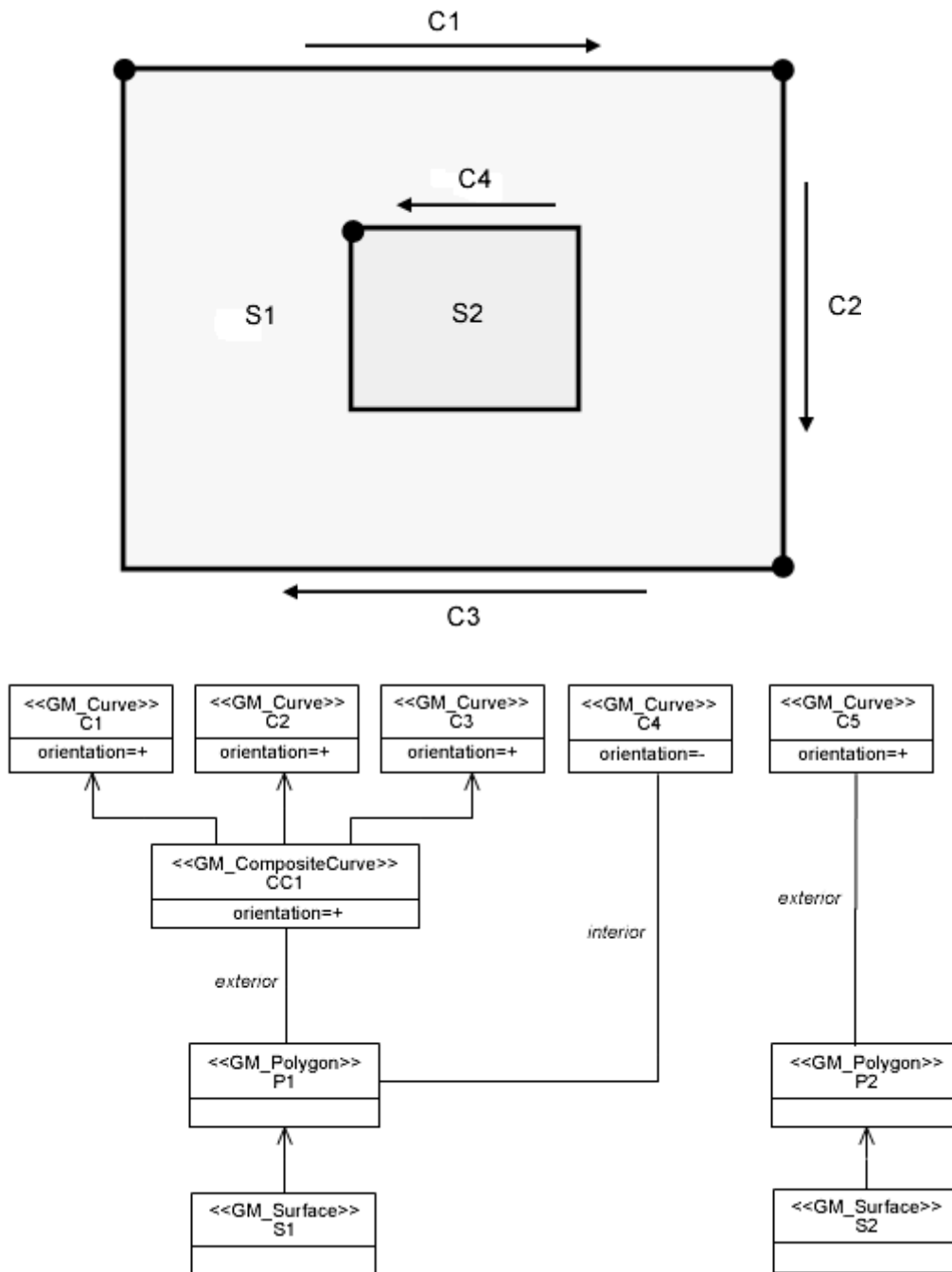
### 7-A-1. Curve Example



**Figure 7-A.1 — Curve Example**

The following describes the geometrical elements of the curve example (Figure 7-A.1). C1 (GM\_Curve) consists of CS1, CS2 and CS3 (GM\_CurveSegment). CS1 uses a geodetic interpolation, CS2 linear and CS3 circularArc3Points. SP (start point) and EP (end point) (GM\_Point) are the start and end points of C1 and can also be used indirectly as a 0 dimension position for a point feature. An array of control points for each segment consists of a combination of SP, EP and vertices as indicated in the above diagram. The orientation of C1 is + (forward) from SP to EP.

## 7-A-2. Surface Example

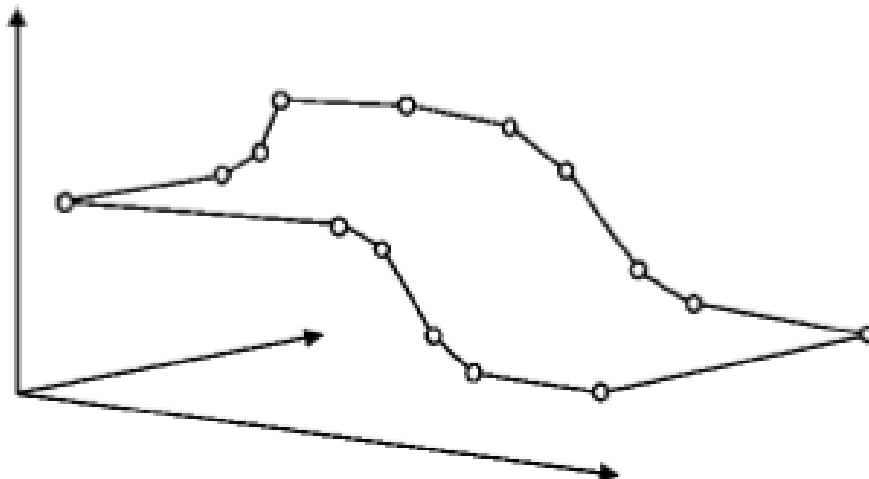


**Figure 7-A.2 – Surface Example**

The following describes the geometrical elements of the surface example (Figure 7-A.2).

S1 (GM\_Surface) is represented by the surface patch P1 (GM\_Polygon) the boundary of which consists of exterior and interior rings. The exterior ring CC1 (GM\_CompositeCurve) is an aggregation of C1, C2, C3 (GM\_Curve), the interior ring C4 is a simple GM\_Curve.

### 7-A-3. 2.5 Dimensional Geometry Example



**Figure 7-A.3 – 2.5D Example**

In the depicted example, the curve which constitutes the exterior boundary of a GM\_Polygon consists of an array of 3D control points. Note that the surface interpolation must be “none”, which means that the position of interior points is not determined. The “planar” interpolation would only be acceptable if all points were lying on a plane.

# **S-100 – Part 8**

## **Imagery and Gridded Data**





## Contents

8-1	Scope .....	1
8-2	Conformance .....	1
8-3	Normative references .....	1
8-4	Symbols and abbreviated terms .....	2
8-5	Imagery and Gridded Data Framework .....	3
8-5.1	Framework structure .....	3
8-5.2	Abstract Level .....	5
8-5.3	Content Model Level .....	5
8-5.3.1	Metadata .....	7
8-5.3.2	Encoding .....	8
8-6	Imagery and Gridded Data Spatial Schema .....	9
8-6.1	Coverages .....	9
8-6.2	Point Sets, Grids and TINs .....	9
8-6.2.1	Point Sets .....	9
8-6.2.2	Grid Types .....	10
8-6.2.3	Rectangular grids and irregularly shaped grids .....	11
8-6.2.4	Simple and tiled grids .....	12
8-6.2.5	Regular and variable cell sizes .....	13
8-6.2.6	Grids in 2 or 3 dimensions .....	15
8-6.2.7	TIN .....	16
8-6.3	Data Set Structure .....	17
8-6.3.1	Data Set Class .....	18
8-6.3.2	S100_Discovery Metadata Module .....	18
8-6.3.3	S100_Transmittal .....	19
8-6.3.4	S100_IG_Collection .....	19
8-6.3.5	S100_Collection Metadata Module .....	19
8-6.3.6	S100_Structure Metadata Module .....	19
8-6.3.7	S100_Acquisition Metadata Module .....	19
8-6.3.8	S100_Quality Metadata Module .....	19
8-6.3.9	S100_IG_Data Type .....	19
8-6.3.10	Components .....	19
8-6.3.11	S100_Tiling Scheme .....	19
8-7	Tiling Scheme .....	19
8-7.1	Spatial Schema .....	20
8-7.1.1	S100_Point Set Spatial Model .....	20
8-7.1.2	S100_PointCoverage Spatial Model .....	21
8-7.1.3	S100_TIN Coverage Spatial Model .....	22
8-7.1.4	S100_Grid Coverage Spatial Model .....	25
8-7.2	Rectified or Georeferencable Grids .....	27
8-8	Data Spatial Referencing .....	27
8-8.1	Gridded Data Spatial Referencing .....	28
8-8.1.1	Georectified .....	28
8-8.1.2	Ungeorectified .....	29
8-8.1.3	Georeferenced .....	29
8-8.1.4	Georeferencable .....	30
8-8.2	Point Set Data and TIN Triangle Vertex Spatial Referencing .....	30
8-8.3	Imagery and Gridded Data Metadata .....	30
8-8.4	Quality .....	31
8-9	Imagery and Gridded Data Portrayal .....	32
8-10	Imagery and Gridded Data Encoding .....	32
8-11	Spatial Schema for Point Sets .....	32
8-11.1	Gridded data .....	32
8-11.2	Scanned Image .....	33
8-11.3	Variable Cell Size Grid .....	35
8-11.4	Feature Oriented Image .....	37
Appendix 8-A	Abstract Test Suite .....	39
Appendix 8-B	Terminology .....	41
Appendix 8-C	Quality Model for Imagery and Gridded Data .....	42
Appendix 8-D	Metadata .....	43

Appendix 8-E Portrayal of Imagery and Gridded Data .....47  
Appendix 8-F Feature Oriented Images .....50

## 8-1 Scope

S-100 has the capability to support imagery, gridded and several other types of coverage data as an integral component. Imagery and gridded data are common forms of geographic data and there exist many external standards designed to handle such data. An image is a particular type of gridded data structure that can be visualized. Since almost all sets of gridded data can be portrayed to form an image, the term image is very broad. S-100 must not preclude compatibility with external sources of data.

Hydrographic soundings are by their nature a set of measured data points. These data points can be represented in a grid structure in several different ways, including elevation models using a regular grid spacing, and irregular grids with variable size cells. They can also be represented as Triangular Irregular Networks (TIN triangles) or as point sets. Images are also of great importance for hydrographic data. This includes images from sensors such as aerial photography or LIDAR, photographs that can be associated with vector based feature oriented data and products based on scanned paper charts, commonly known as “Raster Charts”. All of these applications of imagery and gridded data are covered by this component of S-100. This imagery and gridded data component aligns with the international standards for imagery and gridded data in order to support multiple sources of data and uses the common information structures based on the ISO TC/211 19100 suite of standards that allows imagery, gridded and coverage data to be combined with boundary defined (vector based) data and other types of data.

The applicable hierarchical terminology is standardized in the ISO 19100 suite of standards. A set of data that describes a set of attribute values distributed over an area is called a coverage of which there are many different types, but the most common structure is a grid. Presently, S-100 only addresses grid based coverages, point set coverages, and TIN coverages.

This Part of S-100 is based on ISO 19129 – “Geographic information – Imagery, Gridded and Coverage Data Framework”. However, it is more specific than the ISO 19100 suite of standards and defines specific grid organizations to be used for hydrographic data and images associated with hydrographic data. Both simple grids and complex multidimensional grids are defined, as well as point sets and TINs. This Part identifies the content model for coverage data for use in hydrographic applications, including imagery as a type of gridded data. It describes the organization, type of grid or other coverage structure and associated metadata and spatial referencing for georeferenced data. The encoding and portrayal of imagery, gridded and coverage data is external to this part of S-100, although the manner by which encoding and portrayal makes use of the identified content models are identified.

## 8-2 Conformance

The Abstract Test Suite presented in Appendix 8-A indicates how a coverage based product complies with the content models established in this document.

Any product addressing imagery, gridded or coverage data, claiming conformance with S-100 shall pass the requirements described in the abstract test suite, presented in Appendix 8-A.

## 8-3 Normative references

The following external normative documents contain provisions, which through reference in this text constitute provisions of this standard. All of the relevant information from these base standards that applies to S-100 has been included in this standard. Access to these base standards is required only if one wishes to develop generic applications that encompass and exceed the scope of S-100. Other components of S-100 may include information extracted from these and other external standards.

ISO 19103, Geographic information — Conceptual schema language  
ISO 19107, Geographic information — Spatial schema  
ISO 19108, Geographic information — Temporal schema  
ISO 19111, Geographic information — Spatial referencing by coordinates  
ISO 19113, Geographic information — Quality principles  
ISO 19114, Geographic information — Quality evaluation procedures  
ISO 19115, Geographic information — Metadata  
ISO 19115-2, Geographic information — Metadata - Part 2 Extensions for imagery and gridded data  
ISO 19117, Geographic information — Portrayal  
ISO 19118, Geographic information — Encoding  
ISO 19123, Geographic information — Schema for coverage geometry and functions  
ISO 19129, Geographic information — Imagery, Gridded and Coverage Data Framework  
ISO 19130, Geographic information — Sensor and data models for imagery and gridded data  
ISO/IEC 12087-5:1998 - Computer graphics and image processing -- Image Processing and Interchange (IPI) - Functional Specification - Basic Image Interchange Format (BIIF)  
ISO/IEC 15444-1:2004 - Information Technology -- JPEG 2000 image coding system  
IHO S-52 Specifications for Chart Content and Display Aspects of ECDIS  
IHO S-61 Product Specification for Raster Navigational Charts (RNC)  
American National Standard T1.523-2001 - Telecommunications Glossary 2000.

#### **8-4 Symbols and abbreviated terms**

For the purposes of this component of S-100, the following symbols and abbreviated terms apply.

TIN                      Triangulated Irregular Network

## 8-5 Imagery and Gridded Data Framework

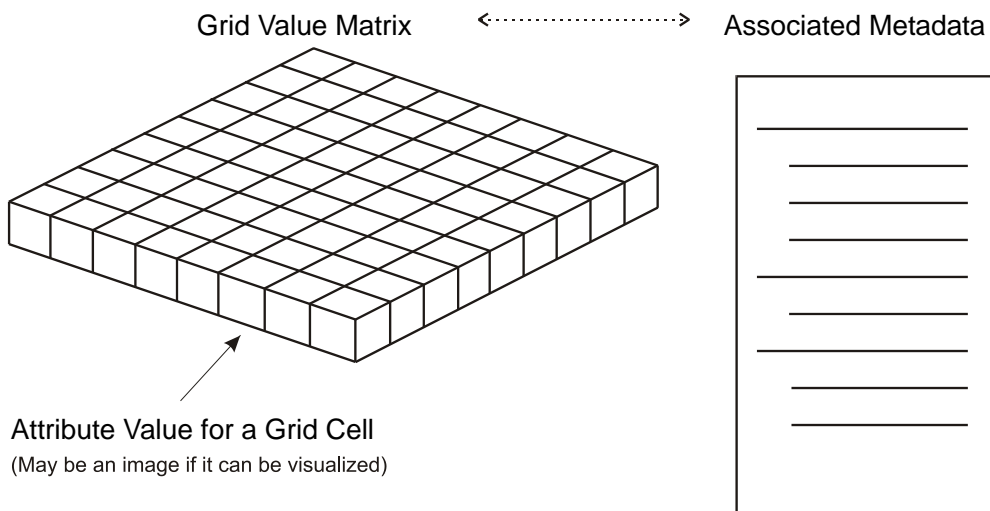
### 8-5.1 Framework structure

The framework for Imagery, Gridded and Coverage data used in this Part of S-100 is derived from ISO 19129 Imagery, Gridded and Coverage data Framework. Only a subset of the framework defined in the ISO standard is required in S-1001. The framework as described in ISO can support both georeferenced and georeferenceable data. This component of S100 is limited to georeferenced data although it can easily be extended in the future to address georeferenceable data such as sensor data.

The framework identifies how the various elements of a coverage data set fit together. The framework provides a common structure that establishes an underlying compatibility between different sets of coverage data. The common framework established in ISO 19129 fosters a convergence at the "Content Model" level between different sets of imagery and gridded data expressed using different standards and also between the information holdings expressed using these standards. An underlying compatibility at the content model level for a broad range of imagery and gridded data allows for backward compatibility with existing standards. The content model describes information independent of the way in which it is stored, communicated or portrayed. This permits multiple encodings for the same content.

Gridded data, including imagery data, is fundamentally simple. It consists of a set of attribute values organized in a grid together with metadata to describe the meaning of the attribute values and spatial referencing information to position the data. Other coverage data is also simple. It also defines a set of points or triangles that drive a coverage function together with metadata. The metadata may contain identification information, quality information, such as the sensor from which the data was collected. The spatial referencing information contains information about how the set of attribute values is referenced to the earth. The spatial referencing information itself is expressed as metadata.

Auxiliary information, also expressed as metadata, may assist in portrayal or encoding, however the basic content may be portrayed in different ways or carried using different encoding mechanisms, so such auxiliary information is not a part of an imagery and gridded data content model. Figure 8-1 illustrates the simple structure of gridded data.



**Figure 8-1 – Simple Structure of Gridded Data  
(Showing the Relationship of Metadata to  
a set of Gridded Data Represented in a Grid Value Matrix)**

1 There is a commonality between the text in portions of this standard and in the ISO standard 19129 because sections of this document have been contributed to ISO as input in the development of ISO 19129 and have thus been incorporated into the ISO document.

The ISO 19129 framework standard allows Imagery, Gridded and Coverage data to be described at several levels. These are an abstract level as addressed in ISO 19123 Geographic information - Schema for coverage geometry and functions, a content model level and an encoding level. The encoding level is independent from the content level. Multiple different encodings may carry the same content.

Most of the existing standards relating to imagery and gridded data describe data content in terms of its representation in an exchange format. The format defines data fields and describes the contents and meaning of these data fields. This implicitly defines the information content that can be carried by the exchange format. Defining the content in terms of its encoding binds the content to that single encoding format and makes data conversion very difficult.

The ISO 19100 suite of standards defines geographic information content in terms of an object oriented data model expressed in the Unified Modeling Language (UML). which allows the content to be encoded using different exchange formats or stored in a database irrespective of the exchange encoding. The following figure, corresponding to ISO 19129, presents the overall relationship between the elements of the framework.

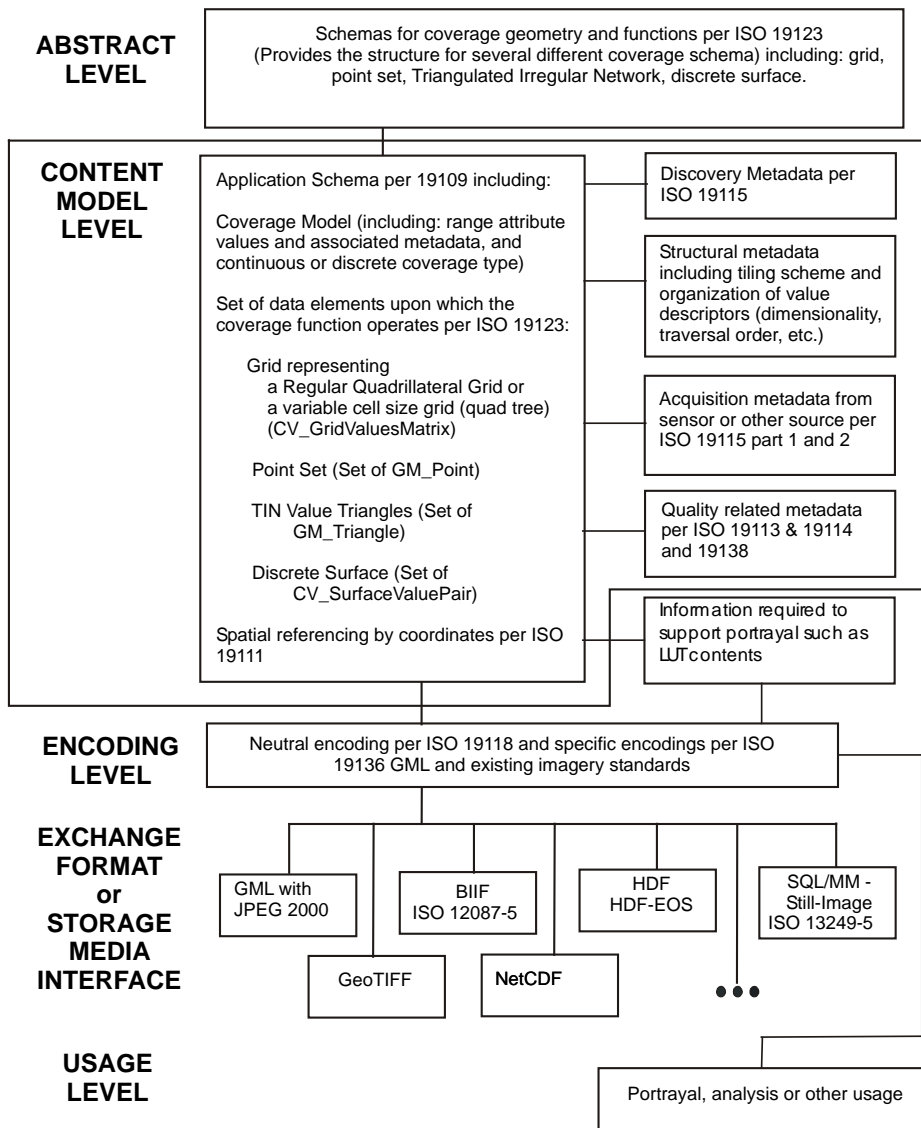


Figure 8-2 – Overall relationship between the elements of the framework

## 8-5.2 Abstract Level

The abstract level provides a generic structure for all types of coverage geometries including gridded data geometries and point set and TIN geometries. This abstract structure is defined in ISO 19123 – Geographic information – Schema for coverage geometry and functions. S-100 takes from ISO 19123 various types of grid structures including a rectangular grid, an irregularly shaped grid, a grid with variable cell sizes and a multi-dimensional grid. A tiled grid is actually a set of grids. S-100 also includes a point coverage and a TIN coverage derived from ISO 19123.

## 8-5.3 Content Model Level

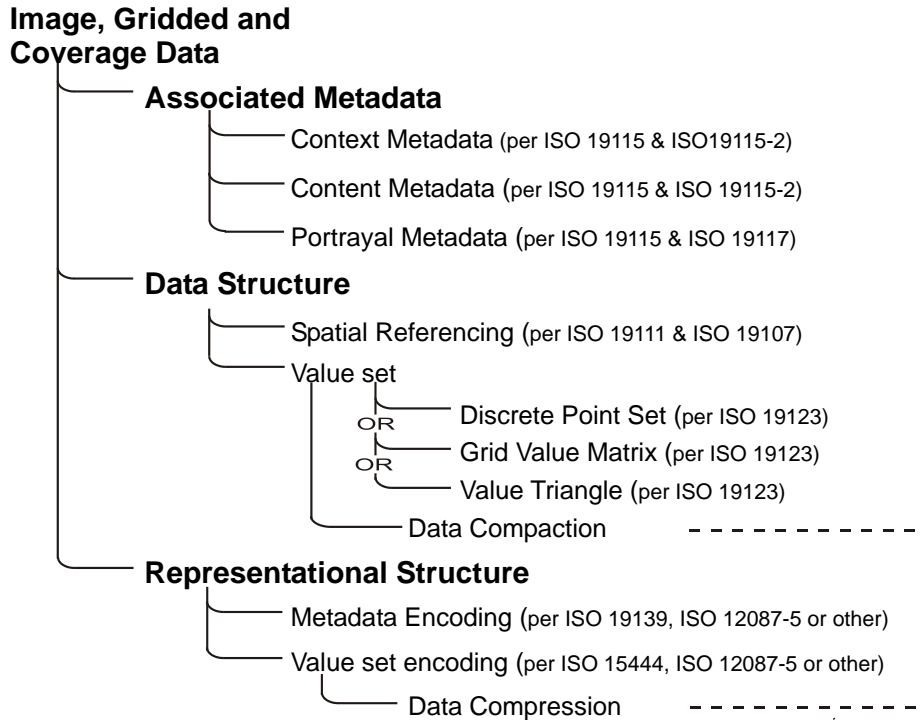
The content model level describes the information content of a set of geographic information consisting of: the spatial schema, feature identification and associated metadata, where other aspects such as quality, geo-referencing, etc, is represented in the metadata. The content model does not include portrayal or encoding or the organization of the data to accommodate various storage or exchange media. Exchange metadata that describes the information about a data exchange is not part of the information defined by the content model.

The content model level consists of a set of predefined content structures, which serve as the core for various application schemas to be developed for imagery and gridded data. A small set of grids, with associated traversal orders are defined. This provides the spatial organization for gridded data. A point set structure and a TIN structure are also defined.

The feature model defined in ISO 19109 “Geographic information - Rules for application schema, applies to imagery and gridded data”. Although the conventional approach is to consider an image as a unique entity on its own, and to not consider a feature structure, it is proper to consider imagery, gridded and coverage data as feature oriented data. In the simplest form, an image or any set of gridded data can be considered as a single feature. For example, an entire satellite image could be considered as a single feature – the image. However, it is also possible to do feature extraction on an image, where sets of pixels are the geometric representation of a feature. Certain selected pixels could correspond to a bridge, and other pixels correspond to a rock. An application schema can contain a feature model, where the geometric component of the feature model consists of sets of geometric points corresponding to the picture elements (pixels) in a grid structure of an image. However, if a feature structure is associated with an image it is necessary to provide a method of linking feature IDs to individual pixels in the image. This can be done by carrying additional attributes in the grid value matrix, or by a pointer structure. For example, an image may be represented as a simple grid consisting of a set of rows and columns providing organization to a set of pixels. Each pixel contains attributional data such as the colour and light intensity seen at that point. Each pixel may also contain an additional attribute that indicates the feature ID associated with the pixel, so that the pixels corresponding to the image of a bridge are marked as the feature bridge, and those corresponding to a rock are marked as rock. Other more efficient structures may be defined to identify sets of pixels as corresponding to a given feature. This capability is particularly useful for adding intelligence to raster scanned image paper chart products, and for fusing S-100 vector data products with imagery and gridded data products.

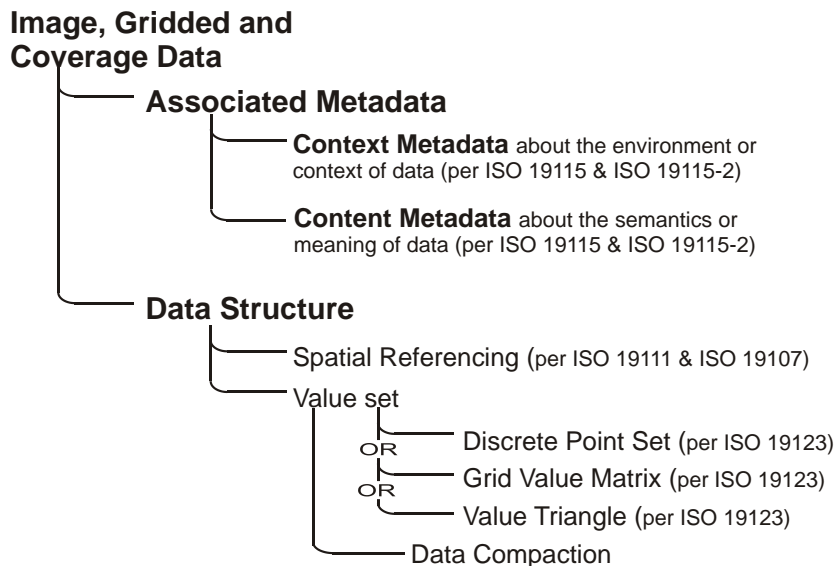
The Content Model includes the spatial structure and the metadata. The encoding structure is separate but related. Systemic compression which allows for data compaction is part of the content model whereas stochastic compression which allows for data compression is not. An example of systemic compression is the removal of information that is known by the application to be not necessary. This would include areas over which there is no data (sub-tiling), and the removal of lower order bits of numeric data for lower precision numbers. A tiled grid exhibits systemic compression when tiles are only defined for areas where there is data. Systemic compression also exists in a variable size pixel structure where adjacent pixels of the same attribute value can be aggregated into a single larger pixel. Stochastic (statistical)

compression removes redundant information that occurs randomly. For example, repeated bit patterns that can be compressed by an algorithm. The ZIP algorithm often used to compress files is an example of stochastic compression. Systemic compression relates to a particular type of image, whereas stochastic compression relates to a particular instance of an image. Both types of compression may be applied, but the stochastic compression is part of the encoding structure, whereas the systemic compression is part of the content model.



**Figure 8-3 – Image and Gridded Data Structure**

Figure 8-4 (below) presents the elements contained in a general content model for imagery gridded and coverage data. This is a subset of Figure 8-3 above, with the representational structure not shown, since it is not part of the content model. The mechanism for systemic compression is not directly shown because it relates to the structure of the Grid Value Matrix.



**Figure 8-4 – General Imagery and Gridded Data Content Description**



### 8-5.3.1 Metadata

The metadata elements that are used in imagery, gridded and coverage data are presented in Table 8-1. The table organizes the metadata elements according to whether the metadata relates to the description of the imagery, gridded or coverage data content, or to the environment in which it exists, or the representation of the data. Additional representational metadata may exist in an encoding format.

**Table 8-1 — Metadata Elements**

Type (Metadata Package)	Description	relationship
<b>Metadata Elements (19115)</b>		
Metadata entity set information	metadata entity set information	Environment
Identification information	information to uniquely identify the data. Identification information includes information about the citation for the resource, an abstract, the purpose, credit, the status and points of contact	Environment
Constraint information	information concerning the restrictions placed on data	Environment
Data quality information	assessment of the quality of the data	Content
Maintenance information	information about the scope and frequency of updating data	Environment
Spatial representation information	information concerning the mechanisms used to represent spatial information	Content
Reference system information	the description of the spatial and temporal reference system(s)	Content
Content information	information identifying the feature catalogue	Content
Portrayal catalogue information	information identifying the portrayal catalogue	Representation
Distribution information	information about the distributor of, and options for obtaining, a resource	Environment
Metadata extension information	information about user specified extensions	Various
Application schema information	information about the application schema used to build a dataset	Content
<b>Metadata Imagery Extensions per 19115-2</b>		
Content Information Imagery	additional information used to identify the content of coverage data	Content
Identification Information Imagery	information to uniquely identify the data, including extensions to describe references that apply to the data and entities to identify the components used to acquire the data.	Environment
Requirements Information Imagery	provides details specific to the tasking and planning associated with the collection of imagery and gridded data	Environment
Acquisition Information Imagery	information on the acquisition of imagery and gridded data	
Data Quality Information Imagery	assessment of the quality of the imagery data	Content
Spatial Representation Information Imagery	additional information the mechanisms used to represent spatial information for imagery	Content
<b>Metadata Datatypes</b>		
Extent information	metadata elements that describe the spatial and temporal extent - "geographicElement", "temporalElement", and "verticalElement"	Content
Extent Information Imagery	defines additional attributes used to specify the location of the minimum and maximum vertical extent values within the dataset	Content

Type (Metadata Package)	Description	relationship
Citation and responsible party information	a standardized method (CI_Citation) for citing a resource (dataset, feature, source, publication, etc.), as well as information about the party responsible (CI_ResponsibleParty) for a resource	Environment

### 8-5.3.2 Encoding

The content model defines the structure to which an encoding rule may be applied. There are a large number of different encodings used for imagery, gridded and coverage data that provide encoding services for this class of information. Many of these encodings are well used standardized exchange formats. S-100 provides a common content model structure that can be encoded or stored using different encoding formats (e.g. Figure 8-2, GeoTIF).

Gridded data, including imagery, is among the simplest data structures for geographic information. However it is data intensive, i.e. there are a large number of picture elements or grid cells in a data set. There are two different kinds of information to encode, the grid value matrix elements (pixels, grid cells) and the metadata about them. These may be encoded in the same integrated standard, or as two separate linked sets of information. In addition most encoding rules for imagery and gridded data include stochastic compression rules to reduce the data volume of the grid value matrix element data.

There are already several ISO standards developed under ISO JTC1 Information Technology that address picture coding and imagery data applicable to the content model structures defined in this document. In particular there are the standards JTC1 SC29, Picture coding and JTC1 SC24 Computer Graphics and Image Processing. These standards should be used where applicable. A number of commercially defined standards or standards defined in other organizations can also be used. A survey of these standards is provided in ISO Technical Report 19121.

Hydrographic data may make use of several different encodings for imagery data. In particular two proprietary formats to handle raster-scanned paper chart data are in wide use. Either format may be used to carry the same scanned paper chart content conforming to a common content model. A different encoding may be appropriate for image data such as satellite imagery or LIDAR imagery. A third encoding may be appropriate for sonar data. All of these data sets would comply with the general content model structure and particular content models for their particular product specifications. Unique encodings are required for point set data and for TIN triangle data.

To promote compatible data exchange it is desirable to have a common neutral encoding format, even if that format is not optimal for the particular data set. There is no decision in the ISO standards regarding the appropriate neutral format-independent encoding because ISO is addressing a broad range of "information communities". A neutral encoding which may be used in S-100 consists of the use of an XML encoding to describe the metadata aspects of imagery and gridded data and an appropriate value element encoding mechanism taken from the ISO JTC1 SC29 standards on picture coding. In particular the ISO 15444-1 JPEG 2000 standard should be used together with XML/GML (ISO 19136) as a neutral encoding for gridded data. A more general encoding is the Hierarchical Data Format (HDF version 5), which is object oriented and suitable for all types of coverage data, including point sets and TIN triangles. HDF 5 forms the basis of NetCDF, a popular format used for scientific data. Regardless of which format is used the content model must be the same so that the data can be converted from one format to another without loss.

## 8-6 Imagery and Gridded Data Spatial Schema

### 8-6.1 Coverages

A coverage associates positions within a bounded space to attribute values. A coverage is a subtype of feature; that is, it associates positions within a bounded space to the attribute values of the feature. A continuous coverage function associates a value to every position within the spatial temporal domain of the function. A discrete coverage function is only valid at specific positions within the domain. Geometric objects within the spatiotemporal domain drive the coverage function. A coverage function effectively acts as an interpolation function for the geometric objects within the spatiotemporal domain, which establishes a value within the range of the function for every position within the domain.

The geometric objects within the spatiotemporal domain are described in terms of direct positions. The geometric objects may exhaustively partition the spatiotemporal domain, and thereby form a tessellation such as a grid or a TIN. Point sets and other sets of non-continuous geometric objects do not form tessellations.

ISO 19107 defines a number of geometric objects (subtypes of the UML class `GM_Object`) to be used for the description of features. Some of these geometric objects can be used to define spatiotemporal domains for coverages. ISO 19123 defines additional subtypes of `GM_Object` that are specialised for the description of spatiotemporal domains. In addition, ISO 19108 defines `TM_GeometricPrimitives` that may also be used to define spatiotemporal domains of coverages.

The range of a coverage is a set of feature attribute values. The value set is represented as a collection of records with a common schema. For example, a value set might consist of temperature and depth measured at a given time over a bounded area of ocean. A coverage function may be used to evaluate a depth and temperature anywhere within the bounded area.

A discrete coverage has a spatiotemporal domain that consists of a finite collection of geometric objects and the direct positions contained in those geometric objects. A discrete coverage maps each geometric object to a single record of feature attribute values. A discrete coverage is thus a discrete or step function as opposed to a continuous coverage. For example assigning a feature code to each cell in a grid cell tessellation is a discrete coverage. Each grid cell is either associated or not associated with a particular feature.

A continuous coverage has a spatiotemporal domain that consists of a set of direct positions in a coordinate space. A continuous coverage maps direct positions to value records. In principle, a continuous coverage could consist of no more than a spatially bounded, but transfinite set of direct positions, and a mathematical function that relates direct position to feature attribute value.

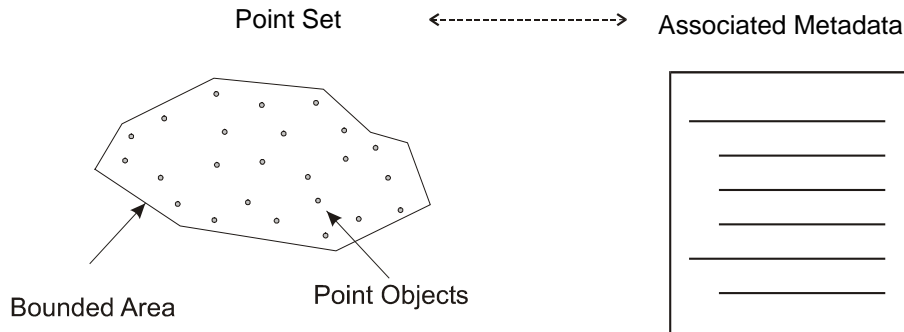
The concept of coverages is described in this document to relate coverage functions to the set of geometric objects and the direct positions that drive the coverage functions. It is through the concept of coverages that one may relate the concept of features to a grid, a set of TIN triangles or a point set. This description has been adapted from ISO 19123. S-100 only addresses grids, TINs and point sets. To address other types of coverages see ISO 19123.

### 8-6.2 Point Sets, Grids and TINs

#### 8-6.2.1 Point Sets

S-100 addresses only imagery and gridded data associated with grids and point sets. These two constructs establish the basic geometry elements used in this component of S-100.

A point set is a set of GM\_Point objects in a bounded area. These point objects might each be associated with one or more features. They may also form a coverage and serve to drive a coverage function. Hydrographic soundings may be considered as a point set. For each point set value it is necessary to know the position of the point as well as any associated attribute value and associated feature reference. Attributes may be assigned to an entire point set as an aggregate as well as to individual points. This is common practise for hydrographic soundings where metadata may be associated with a sounding object that consists of a point set of individual soundings. Several point sets may be aggregated into one coverage. A simple point set with associated metadata is illustrated in Figure 8-5.



**Figure 8-5 – Point Set with Associated Metadata**

A Point Set is a set of 2, 3 or n dimensional points in space. A Point Set Coverage is a coverage function associated with point value pairs in 2 dimensions. That is, a coverage function is driven by a set of points (with X, Y position) together with a record of one or more values at that position.

### 8-6.2.2 Grid Types

A grid is a regular tessellation of a bounded space where two or more sets of curves in which the members of each set intersect the members of the other sets in a systematic way. The curves are called grid lines; the points at which they intersect are grid points, and the interstices between the grid lines are grid cells. A grid covers the entire bounded space. Grids form the basic geometry for a gridded data coverage. There are several different regular tessellations of a space that are all subtypes of the general concept of grid. Common to all grids is an implicit sequence or traversal order. There also exist a number of possible traversal orders for grids, some more useful than others in different situations. The location of a grid cell is defined implicitly by the regular grid organization and the traversal order. For example, in a rectangular grid each grid cell can be addressed by the row and column order of the grid. It is therefore not necessary to maintain the direct position of each grid cell. More complex grids require more complex traversal orders, however regularity still permits the position within the grid to be determined from the grid structure and the traversal order. The attribute values for a particular grid form a Grid Value Matrix where the matrix entries correspond to the grid cells.

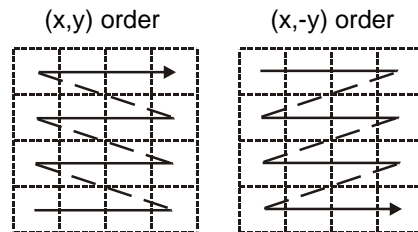
S-100 addresses only a small subset of the possible grids and traversal orders. It makes use of only the CV\_ContinuousQuadrilateralGridCoverage described in clause 8 of ISO 19123. It makes use of:

- 1) Rectangular grids and irregularly shaped grids;
- 2) Simple and tiled grids;
- 3) Grid with a regular cell size and variable cell sizes; and
- 4) Grids in 2 or 3 dimensions.

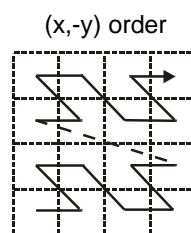
Traversal orders for grids are defined in Annex C of ISO 19123. The types of interest to S-100 are: Linear Scan; and Morton Order. Figure 8-6 shows a linear scan traversal order and a

Morton traversal order for a grid. The Morton ordering can easily accommodate irregular shaped grids, and variable cell size grids. The Morton Order corresponds to a quad tree in two dimensions but is extendable to higher dimensions.

### Linear Scan Traversal Order in 2 dimensions



### Morton Order in 2 dimensions with regular size



**Figure 8-6 – Linear Scan Row Column (X,Y) Traversal Order and Morton (X,Y) Order**

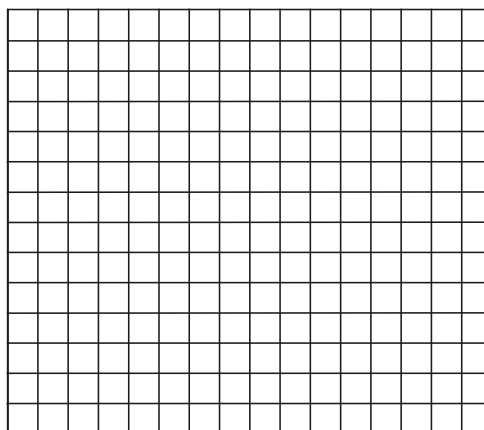
These two types of grids and traversal orders have applications for hydrographic data (e.g. section 8-6.2.5 – Morton Order).

Other traversal orders are defined in the ISO standard 19123.

### 8-6.2.3 Rectangular grids and irregularly shaped grids

The most common type of grid is a rectangular grid. Most images are defined on such a grid. A rectangular grid is a subtype of quadrilateral grid as defined in ISO 19123. A quadrilateral grid is a grid in which the curves are straight lines, and there is one set of grid lines for each dimension of the grid space. In this case the grid cells are parallelograms or parallelepipeds. A parallelepiped is a three-dimensional figure like a cube, except that its faces are not squares but parallelograms.

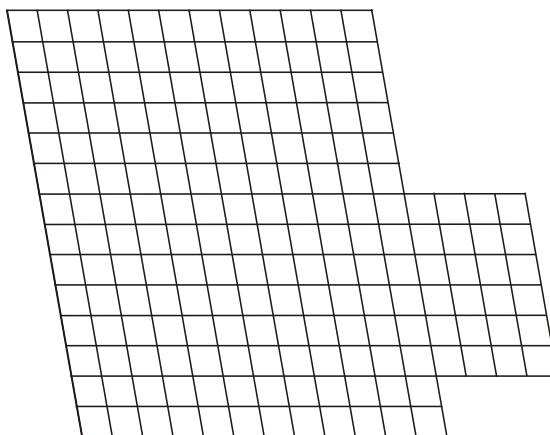
### Rectangular (orthogonal quadrilateral) Grid



**Figure 8-7 – Rectangular Grid**

A grid may also have a non-rectangular or quadrilateral boundary. Such grids sometimes occur when scanning paper charts that include “insets” or “outsets” that change the boundary of the grid, however the grid can have any shape, as long as it can be traversed in a sequence that gives order to the cells. Figure 8-7 shows a Rectangular Grid. Figure 8-8 shows a quadrilateral grid with an outset, as might occur in a scanning operation.

Quadrilateral Grid with irregular shape.

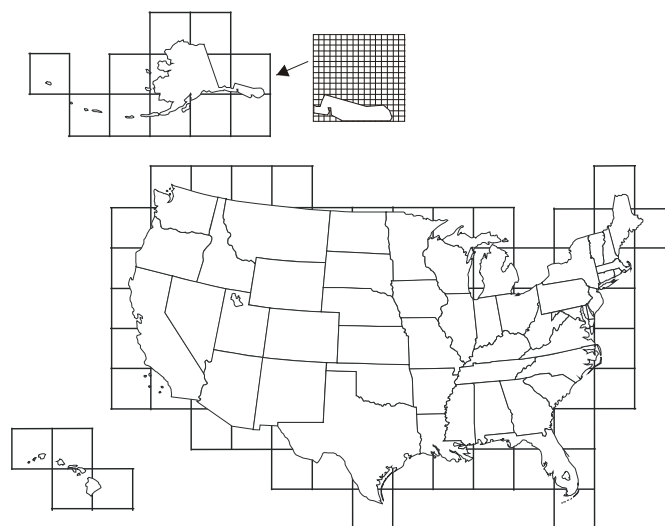


**Figure 8-8 – Quadrilateral Grid with Outset**

Very irregular shaped grids may be defined but require a more complex traversal rule than simple linear scanning.

#### 8-6.2.4 Simple and tiled grids

A tiled grid is a combination of two or more grid tessellations for one set of data. The tiling scheme is essentially a second grid that is superimposed on the first simple grid. Each cell of the tiling scheme grid is itself a grid. A tiling scheme grid may also be used with vector data where each cell defines the boundaries of a particular vector data set. Tiling schemes are of particular value when data is sparse. For example, a raster image map of the United States might be tiled so that it is not necessary to include data over Canada or over the ocean to include Alaska and Hawaii. Figure 8-9 illustrates a tiled grid.

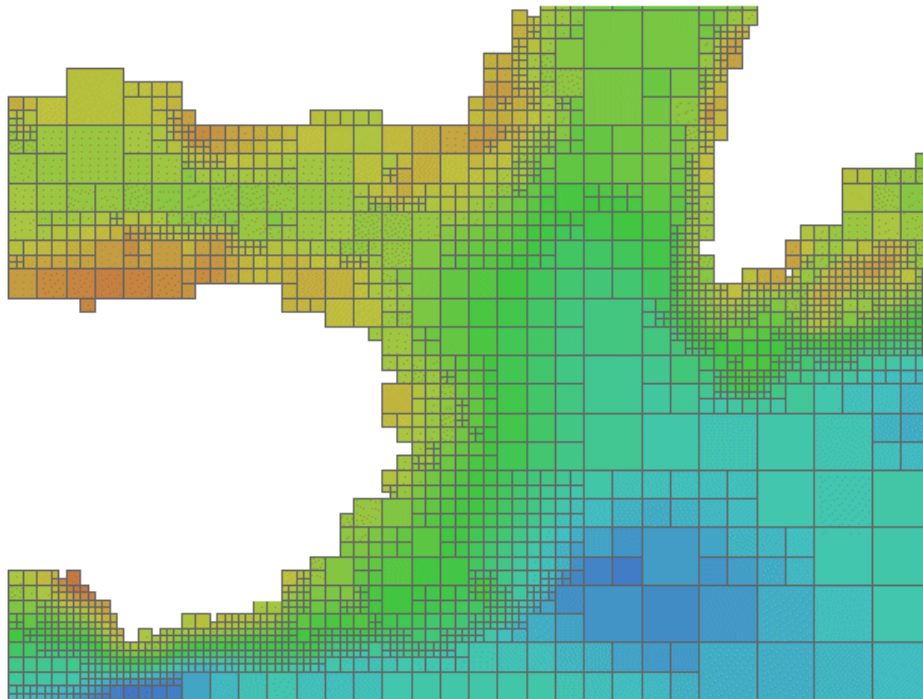


**Figure 8-9 – Tiled Grid**

### 8-6.2.5 Regular and variable cell sizes

Traditional grids are fixed 'resolution', most commonly composed of perpendicularly crossing lines of equal spacing on each dimension, creating square or rectangular cells. Gridding is a standard way of generalizing point data sets, by imposing a resolution or grid spacing, and calculating individual grid cell values based on a single attribute of the group of points contained within each cell. As well, image data is primarily gridded, based on the resolution of the sensor or uniform arbitrary pixel spacing.

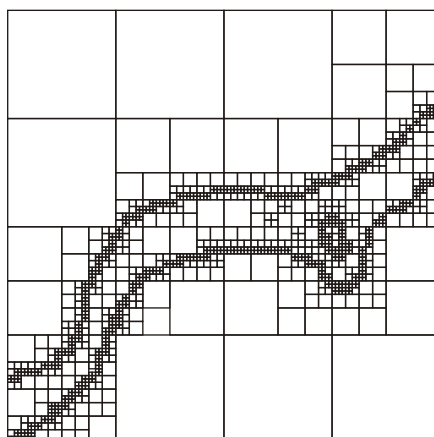
Grids may also be established where the cell size varies within the grid. A common example is the "quad tree" that is commonly used in some Geographic Information Systems. Having a variable size grid cell allows variable resolution throughout the gridded surface, which is exhibited by the unequal spacing of parallel lines that form the grid, localized to given grid cells. This requires the normalization of data on each dimension, and the binary subdivision of each dimension in order to localize any given cell. When applied to point or image data, areas of high variability can be represented by small grid cells. Areas of low variability can be represented by large grid cells. Of course if the cell size varies in a grid, it must do so in a regular way so that the grid tessellation still covers the bounded area, and the traversal method must be able to sequence the cells in an order. In addition it is necessary to include information that describes the size of each cell with the cell.



**Figure 8-10 – Riemann Hyperspatial Grid Coverage**  
(showing depth from hydrographic sonar)

Data in a grid of variable cell size where adjacent like cells have been aggregated into larger cells, maintains the integrity of the original uniformly spaced data, while minimizing storage size. A grid with variable cell size supports null values, so incomplete data – that containing holes – can exist without the need to assign arbitrary values to regions of no data. This allows for a considerable amount of compaction over traditional grids because nothing is stored for cells with no data – they do not exist.

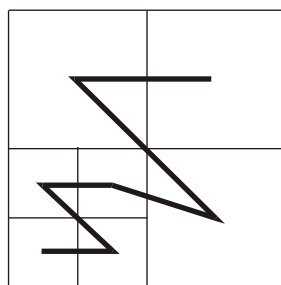
Figure 8-10 illustrates some variable size cells. If four adjacent cells (in two dimensions) have the same attribute value in the grid value matrix, then they may be aggregated into one larger cell. In two dimensions this is known as a "QuadTree". This is of particular use in applications where resolution varies, or where data values tend to cluster.



**Figure 8-11 – Variable Cell Sizes**

Variable size cells, as illustrated in Figure 8-11, are particularly useful for hydrographic data. Instead of representing bottom cover as soundings (point sets) it can be represented as a set of variable size cells. Each cell can carry several attribute values. Adjacent cells aggregate so the data volume is greatly diminished. Small cells exist where there is a rapid change in attribute value from cell to cell. Shoals, shore line and obstructions result in a number of small cells, where large relatively constant, or flat areas, such as the bottom of a channel result in a number of aggregated cells.

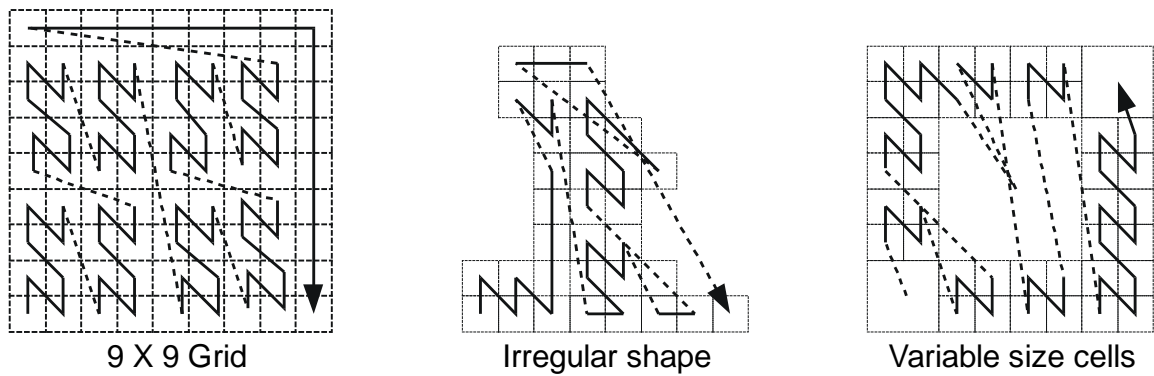
The Morton traversal order can handle variable size cells. The traversal progresses as shown in Figure 8-12. Morton order proceeds from left to right bottom to top cell by cell regardless of cell size. It increments in the X coordinate then the Y. This also extends to multiple dimensions where the increment is in X, then Y then Z then each additional dimension. Figure 8-13 shows Morton ordering in irregular grids and variable size grids. In this example Y, X ordering is used.



**Figure 8-12 – Morton Order (X,Y)**

Any space filling curve gives order to a bounded space, but the order imparted by the Morton order preserves nearness. This is a very important property. It means that two points that are close together in the grid are also close together in traversal order of the grid. This property derives from Riemann's extension of the Pythagorean theorem into multiple dimensions into what is known as Riemann hyperspace.



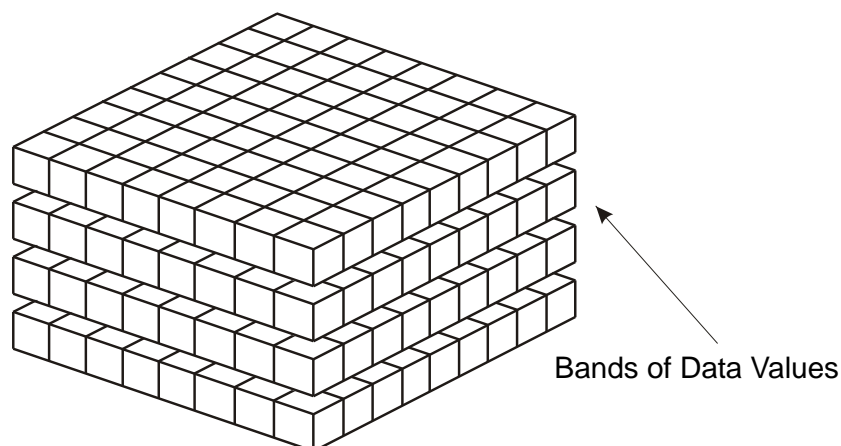


**Figure 8-13 – Morton Order in irregular and variable size grids**

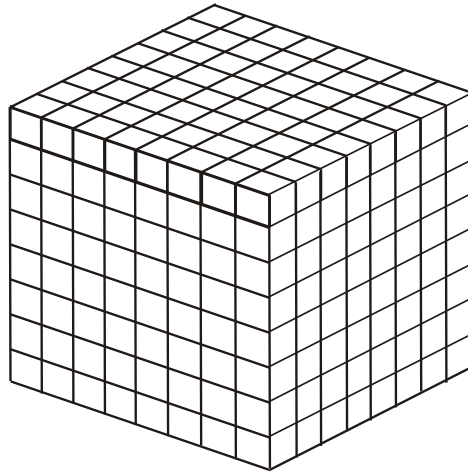
### 8-6.2.6 Grids in 2 or 3 dimensions

Grids may exist in 2 or 3 dimensions. Not all traversal orders will work on higher dimensional grids, but both the linear scan traversal and Morton order traversal can be extended to 3 dimensions. Each dimension in an  $n$ -dimensional grid is orthogonal to all other dimensions. Thus, in a 3-dimensional grid or equal cell spacing, there are a set of perpendicularly crossing lines of equal spacing in each dimension, creating cubic cells. These can be thought of as volume elements – *voxels*.

A quadrilateral grid can easily be extended to 3 dimensions by repeating the grid for each cell “layer” in the third dimension. This is commonly done to support multiple bands of data for the same cell structure, however for true 3 dimensions where the number of cells in the third dimension is large the data volume can become enormous. Figure 8-14 shows a rectangular grid that is extended into the third dimension by repeating the grid for four different bands of data. Figure 8-15 shows a rectangular grid extended to cover a volume.

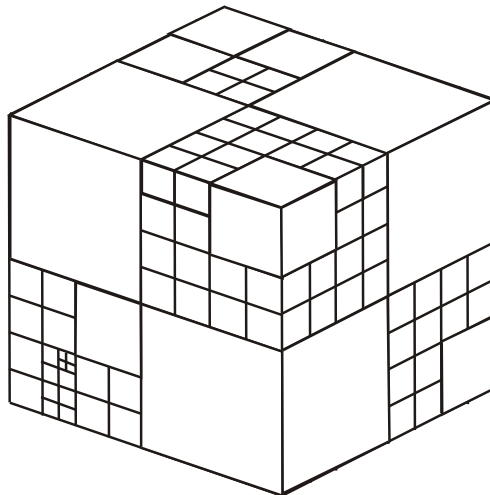


**Figure 8-14 – Banding to Extend Attribute Space in a Rectangular Grid**



**Figure 8-15 – A Rectangular Grid Extended to cover Three Dimensional Volume**

Multidimensional Complex Grids exist in  $n$ -dimensions and will follow the rules of both these structures, allowing the creation for multidimensional, multi-resolution, aggregate structures. In hydrographic applications one is usually not interested in three dimensional solids but rather the three dimensional representation of the sea bottom and material, including floating material within the water volume related to the sea bottom. Such data sets are sparse, where most of the volume cells (voxels) are empty. If one allows three dimensional cells to aggregate into larger cells when they are the same (within a pre defined tolerance), then most of the empty cells disappear into a few larger aggregations. The use of variable size cells is useful in handling three and higher dimension data. A variable size cell grid in three dimensions is illustrated in Figure 8-16.

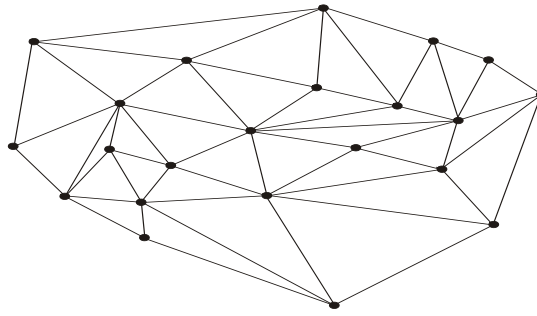


**Figure 8-16 – A Variable Size Cell Grid in Three Dimensions**

#### **8-6.2.7 TIN**

The Triangular Irregular Network is a method of describing variable density coverage data based on a set of triangles. The TIN structure is very flexible for analysis. Since each triangle is a locally flat surface it is straight forward to calculate the intersection of an arbitrary curve with a surface represented as a TIN. Attributes can be applied to each triangular face, and it is easy, but computationally intensive, to process the faces geometrically, in order to calculate contour lines. In a dynamic navigation system one could easily calculate the potential intersection of a ship's hull with the bottom surface represented as a TIN, and therefore easily determine a dynamic safe contour. The calculation of the intersection of a vector with the surface of a TIN triangle is the simple calculation of the intersection of a line and a plane. An

example TIN showing variable size TIN triangles and the TIN vertex points is shown in Figure 8- 17.



**Figure 8-17 – An example coverage composed of TIN triangles**

A TIN is composed of a set of triangles. The vertices at the corners of each triangle are shared with the adjacent triangle. These vertices form the control points of the coverage function. There is an inherent overhead involved in a TIN since one must store both the triangles and the vertices. Attribute values are attached to the triangles, whereas the geometry is derived from the position of the vertices. A TIN may be described either by having the triangles reference the shared vertices at their corners, or by having the vertices indicate which triangles they are attached to. Having the triangles reference the vertices is the simpler structure since each triangle has exactly 3 vertices, whereas a vertex may be shared between a variable number of triangles.

A TIN is useful in representing variable density data, since the triangles may be larger where the data is locally smooth, and more dense to represent data with more rapidly changing values. If the points of the TIN are carefully chosen to represent ridges, valleys and other significant features, then the TIN can result in a significant data compaction; however, if a TIN is automatically generated from an arbitrary set of data points the data volume can increase over the original source data, or significant information can be lost. Since a TIN coverage can be of any shape it can be fitted to cover an area of interest.

### 8-6.3 Data Set Structure

Coverage data as used in S-100 is relatively simple data. It consists of a set of data values together with metadata that describes the meaning of these values. The data values are organized according to a spatial schema. For most types of coverage data this schema takes the form of a coverage schema. The exception is for Point Set data, which is a set of points.

A data set consists of an S100\_IG\_Collection composed of coverages or point sets. Metadata is associated at several levels. Metadata maybe associated with the data set as a whole, or with the coverage or point set. Metadata may also be associated with particular data elements where needed. More detailed metadata at a lower level overrides general metadata for an entire coverage or collection. Metadata may also be associated with particular regions of a data set or other grouping of data set elements.

The description of metadata may be organized in several different ways. In this standard the metadata is organized into modules. The Discovery Metadata Module relates to the data set as a whole whereas other metadata applies to the S100\_IG\_Collection. The S100\_Collection Metadata Module refers to the S100\_Discovery Metadata Module, the S100\_Structure Metadata Module, the S100\_Acquisition Metadata Module and the S100\_Quality Metadata module as sub-components.

Coverages or Point Set data may also be organized into tiles. Metadata may also be associated with a tile. The overall structure of a data set is illustrated in Figure 8-18.

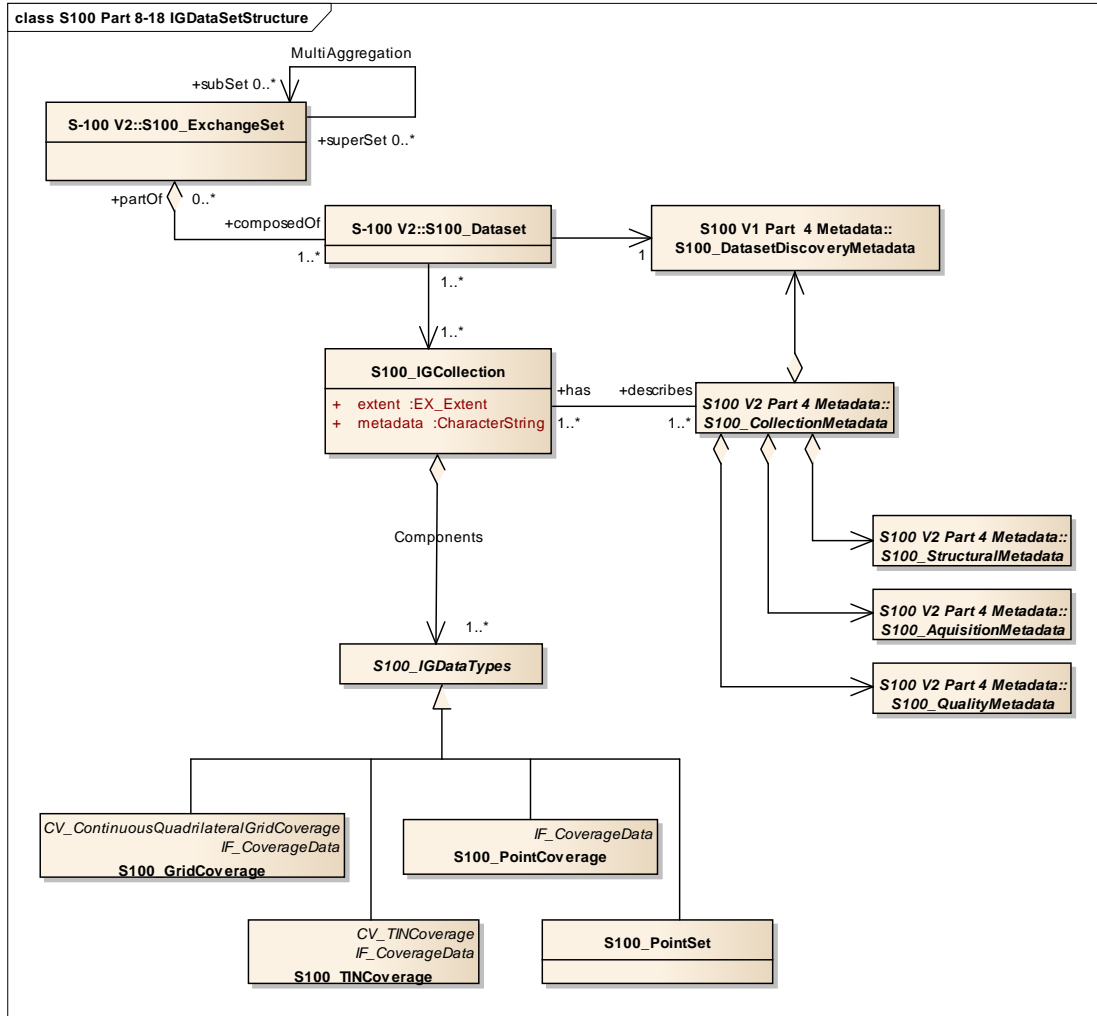


Figure 8-18 – Data Set Structure

**8-6.3.1 Data Set Class**

A data set is an identifiable collection of data that can be represented in an exchange format or stored on a storage media. A data set can represent all or a part of a logical data collection and may include one or many tiles of data. The content of a data set is defined by the Product Specification for that particular type of data and is normally suited to the use of that data. A product specification for a particular data type needs to have a plan that indicates the organization of that data product. For example, a simple gridded bathymetry model based product may have only one bathymetry grid coverage, and a tiling scheme that indicates that every data set contains one tile. More complex products may include several colocated coverages and more complex tiling schemes such as a quad tree based variable size tiling scheme, where one data set may, at times contain more than one tile. The data set is the logical entity that can be identified by the associated discovery metadata, not the physical entity of exchange.

**8-6.3.2 S100\_Discovery Metadata Module**

Associated with a data set is a set of discovery metadata that describes the data set so that it can be accessed. It consists of the "core" metadata defined in ISO 19115.

### **8-6.3.3 S100\_Transmittal**

A transmittal is the encoded exchange format used to carry all, part of, or several data sets. It represents the physical entity of exchange. The transmittal is dependent upon the encoding format and the exchange media. A transmittal on a physical media such as a DVD may carry a number of data sets, whereas a transmittal over a low bandwidth telecommunications line may carry only a small part of a data set. Any metadata carried with a transmittal is integral to the transmittal and may be changed by the exchange mechanism to other exchange metadata as required for the routing and delivery of the transmittal. A common exchange mechanism would be to carry a whole data set on one physical media such as a CD-ROM. Transmittal metadata is not shown because any transmittal metadata, exclusive of the information in the Discovery Metadata Module, is dependent upon the mechanism used for exchange, and may differ from one exchange media or encoding format to another. An example of transmittal Metadata would be counts of the number of data bytes in a unit of exchange.

### **8-6.3.4 S100\_IG\_Collection**

An S100\_IG\_Collection represents a collection of data. A collection may include multiple different data types over a particular area, or multiple coverages of data of the same coverage type, but representing different surfaces. For example a collection may consist of a grid coverage and a point set over the same area, where the grid coverage represents a bathymetry surface and the point set a number of sounding points.

### **8-6.3.5 S100\_Collection Metadata Module**

Associated with an S100\_IG\_Collection is a set of collection metadata that describes the data product as represented in the collection. It consists of a number of sub-components that include the Discovery Metadata Module as well as the Structure Metadata Module, the Acquisition Metadata Module and the Quality Metadata Module. Metadata from the Discovery Metadata Module may be applied to a collection so that the entire collection may be discovered. The other metadata modules are descriptive metadata defined in ISO 19115.

### **8-6.3.6 S100\_Structure Metadata Module**

Associated with a data type is a set of structure metadata that describes structure of the coverage or point set.

### **8-6.3.7 S100\_Acquisition Metadata Module**

Associated with a data type is optionally one or many sets of acquisition metadata that describes source of the data.

### **8-6.3.8 S100\_Quality Metadata Module**

Associated with a data type is optionally one or many sets of quality metadata that describes quality of the data.

### **8-6.3.9 S100\_IG\_Data Type**

This is an abstract class used to represent all of the types of coverage or point set data that may occur in an S100\_IG\_Collection.

### **8-6.3.10 Components**

This role name components identifies the set of data types contained in a collection.

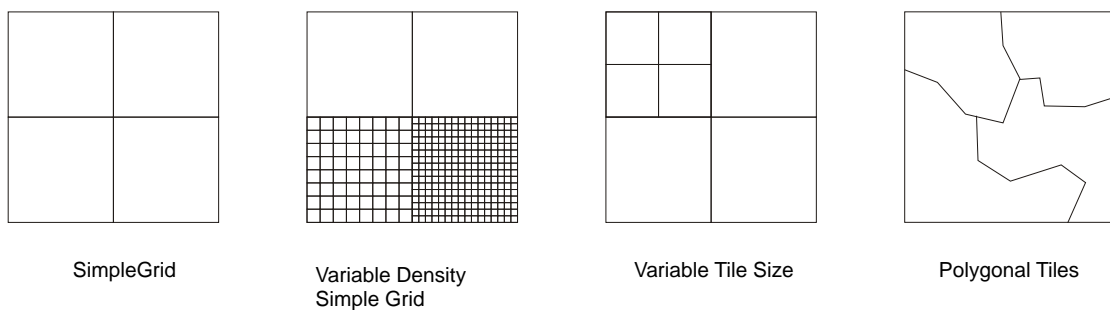
### **8-6.3.11 S100\_Tiling Scheme**

This class is used to describe the tiling scheme used with the S100\_Collection. Metadata identifying a particular instance of a tile is included in the structure module.

## **8-7 Tiling Scheme**

Tiling is one method of reducing the volume of data in a data set to manageable proportions. Clause 7.2.2.2 illustrates the use of tiling. In a data set there must be information both describing the tiling scheme and also about the instance of a tile or tiles carried in that particular data set. The class S100\_TilingScheme carries information about the tiling scheme as a whole. There may only be one tiling scheme defined for a particular data collection. Within a data warehouse (database) there may be several overlapping tiling schemes defined where any of the tiling schemes may be used as the basis of data extraction from the data warehouse.

A tiling scheme is itself a discrete coverage. It is normally a simple rectangular grid with tiles of equal density. Such a grid coverage may also be defined with tiles of variable density. A more complex tiling scheme may also be defined as a discrete polygon coverage. An example is a data collection consisting of elevation cut along political boundaries. These types of tiling schemes are illustrated in Figure 8-19. Other tiling schemes are also possible. In fact, any type of discrete coverage may be used to establish a tiling scheme.



**Figure 8-19 - Tiling Scheme Types**

Any tiling scheme used must be completely described as part of the product specification for a particular data product. This includes the dimensions, location and data density of tiles as well as a tile identification mechanism (tileID).

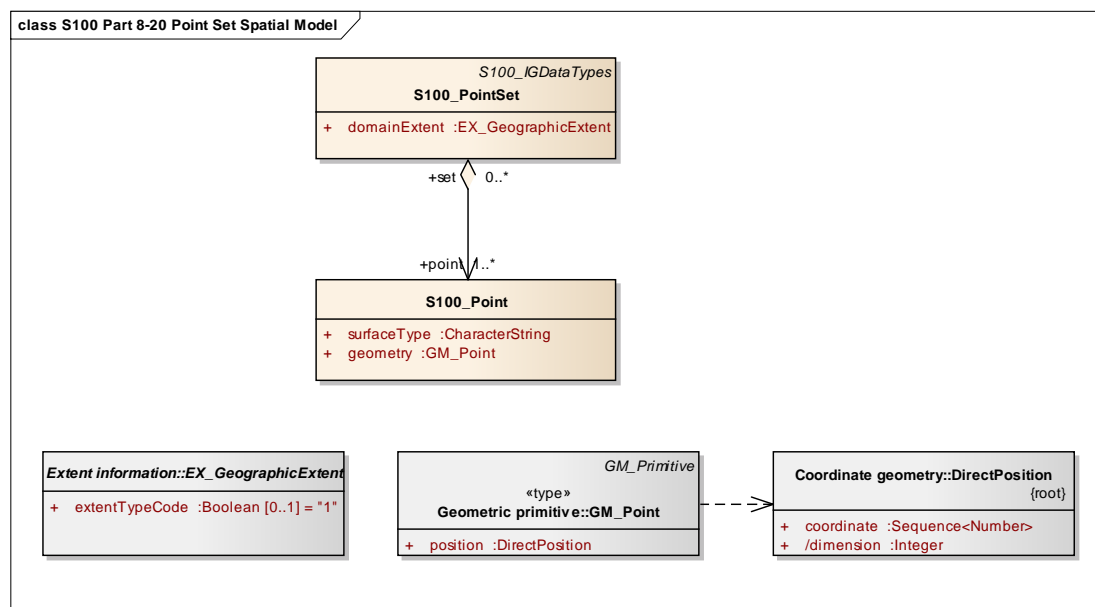
### 8-7.1 Spatial Schema

Each of the S100\_IGDataTypes has a specific spatial schema that describes the structure of that data type. The four data types identified in the S100 Image Gridded and Coverage component are the:

- 1) S100\_Point Set;
- 2) S100\_Point Coverage;
- 3) S100\_TIN\_Coverage; and
- 4) S100\_Grid Coverage.

#### 8-7.1.1 S100\_Point Set Spatial Model

An S100\_Point is a single point referenced to a 3-D coordinate reference system. Its value is carried as a coordinate rather than an attribute. Such points are generated by certain types of sensors. An S100\_Point Set is not a coverage. Each Point in a Point Set has only one value. A Point Set can be used to generate a Point Coverage. The class S100\_PointSet is illustrated in Figure 8-20.



**Figure 8-20 - S100\_Point**

The attribute *domainExtent* describes the spatial extent of the domain of the Point Set.

The attribute *metadata* provides a link to metadata that describes the Point Set. Logically the link is any URI, but it may be implemented as a CharacterString data type that identifies the associated files of metadata.

The attribute *surfaceType* identifies the type of surface that is described by the point, for example, sounding as measured by sonar.

The attribute *geometry* contains an instance of GM\_Point.

### 8-7.1.2 S100\_PointCoverage Spatial Model

An S100\_Point Coverage is a type of CV\_DiscretePointCoverage from ISO 19123. The attribute values in the value record for each CV\_GeometryValuePair represent values of the coverage, such as bathymetric soundings.

The class S100\_Point Coverage (Figure 8-21) represents a set of values, such as bathymetric depth values, assigned to a set of arbitrary X,Y points. Each point is identified by a horizontal coordinate geometry pair (X,Y) and assigned one or more values as attribute values. These values are organized in a record for each point.

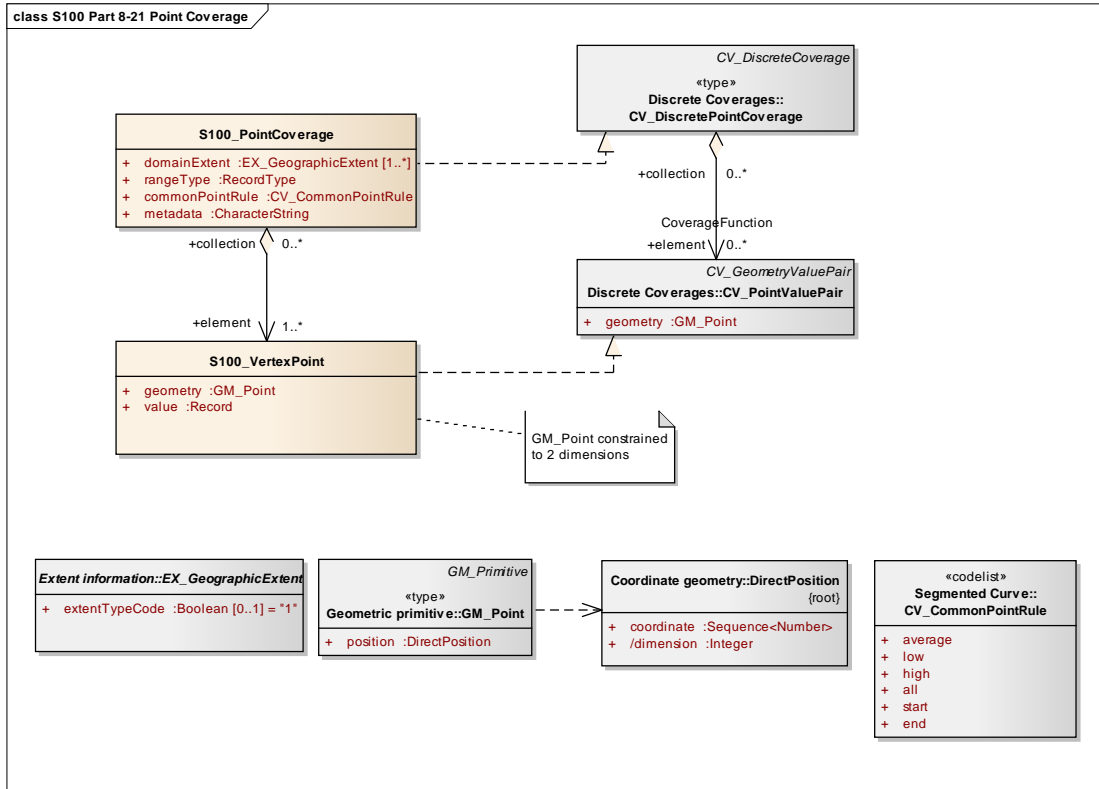


Figure 8-21 - S100\_PointCoverage

The attribute *domainExtent* describes the spatial extent of the domain of the coverage. The attribute *rangeType* describes the range of the coverage. It uses the data type RecordType specified in ISO/TS 19103. An instance of RecordType is a list of name:data type pairs each of which describes an attribute type included in the range of the coverage. The attribute *metadata* provides a link to metadata that describes the coverage. Logically the link is any URI, but it may be implemented as a CharacterString data type that identifies the associated files of metadata.

The attribute *commonPointRule* describes the procedure used for evaluating the coverage at a position that falls on the boundary or in an area of overlap between geometric objects in the domain of the coverage. It takes a value from the codelist CV\_CommonPointRule specified in ISO 19123. The rule shall be applied to the set of values that results from evaluating the coverage with respect to each of the geometric objects that share a boundary. Appropriate values of the CV\_CommonPointRule include 'average', 'high', and 'low'. For example, data used for bathymetric purposes may make use of the 'high' value to ensure that obstructions such as rocks or shoals are emphasised.

The attribute *geometry* contains an instance of GM\_Point.

The attribute *value* contains a record which conforms to the RecordType specified by the *rangeType* attribute.

### 8-7.1.3 S100\_TIN Coverage Spatial Model

A TIN coverage is a type of CV\_ContinuousQuadrilateralGridCoverage as described in ISO 19123. The attribute values in the value record for each CV\_GeometryValuePair represent values for each of the vertex corners of the triangle. Any additional attributes related to a TIN triangle may be described as attributes of CV\_ValueTriangle.



A TIN covers an area with a unique set of non-overlapping triangles where each triangle is formed by three points. The geometry for a TIN is described in ISO 19107 and a TIN coverage is described in ISO 19123. TIN coverages are particularly useful for representing elevation or bathymetry in some applications. It is easier to calculate an intersection with a coverage surface when it is represented as a TIN. The class S100\_TINCoverage is illustrated in Figure 8-22.

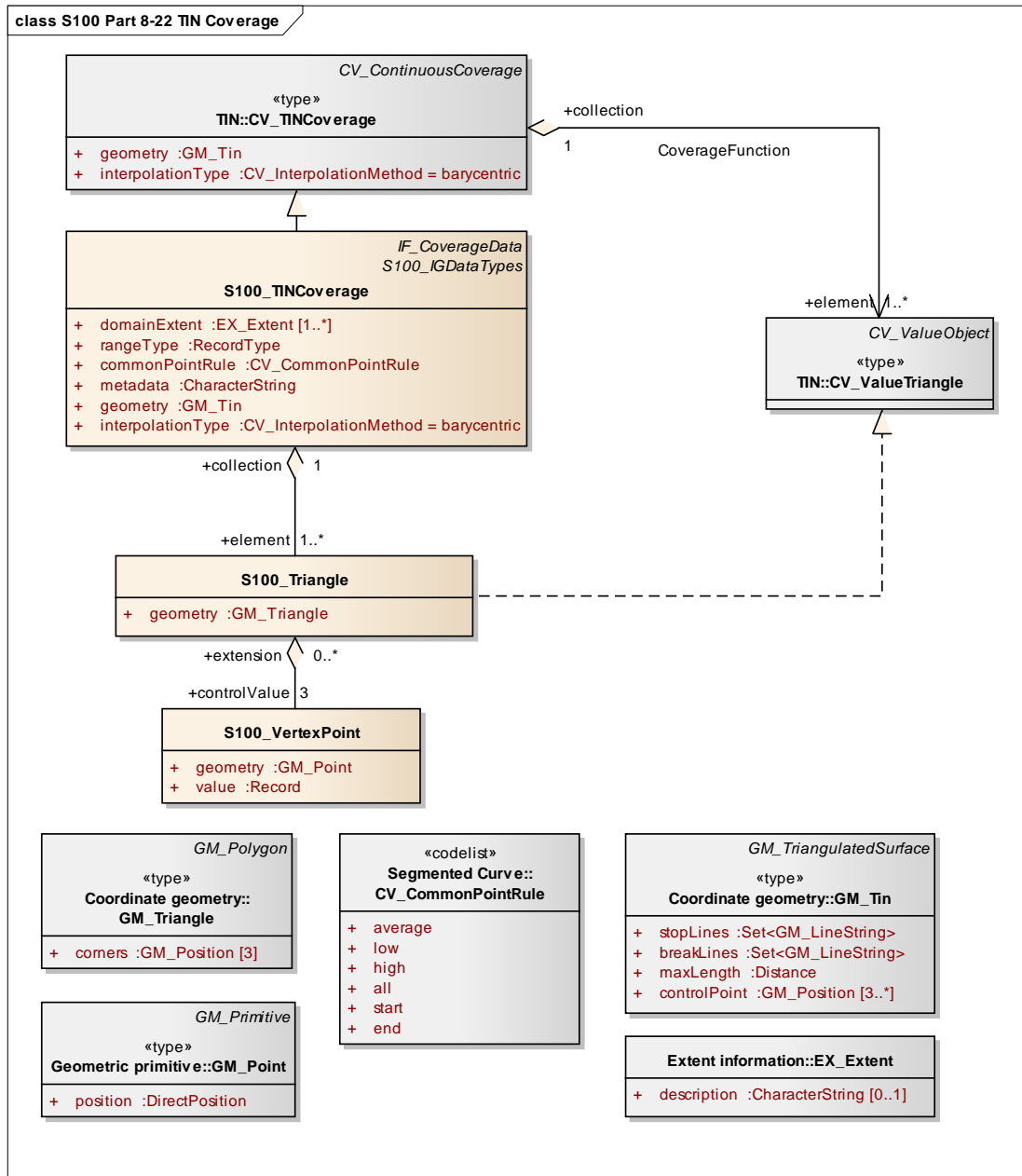


Figure 8-22 - S100\_TIN Coverage

The attribute *geometry* describes the network of triangles that form the basis of the TIN. The triangles lie on a 2 dimensional manifold with the X,Y coordinates of the points at the vertices of the triangles representing the position on the manifold and the attribute.

The attribute *interpolationType* specifies the interpolation method recommended for the evaluation of the S100\_TINCoverage where the value is taken from the codelist CV\_InterpolationMethod with the value "barycentric". The barycentric position S within a value

triangle composed of the CV\_PointValuePairs (P1, V1), (P2, V2), and (P3, V3), is (i, j, k), where  $S = iP1 + jP2 + kP3$  and the interpolated attribute value at S is  $V = iV1 + jV2 + kV3$

The attribute *domainExtent* describes the spatial extent of the domain of the coverage.

The attribute *rangeType* describes the range of the coverage. It uses the data type RecordType specified in ISO/TS 19103. An instance of RecordType is a list of name:data type pairs each of which describes an attribute type included in the range of the coverage.

The attribute *metadata* provides a link to metadata that describes the coverage. Logically the link is any URI, but it may be implemented as a CharacterString data type that identifies the associated files of metadata.

The attribute *commonPointRule* describes the procedure used for evaluating the coverage at a position that falls on the boundary or in an area of overlap between geometric objects in the domain of the coverage. It takes a value from the codelist CV\_CommonPointRule specified in ISO 19123. The rule shall be applied to the set of values that results from evaluating the coverage with respect to each of the geometric objects that share a boundary. Appropriate values of the CV\_CommonPointRule include 'average', 'high', and 'low'. For example, data used for bathymetric purposes may make use of the 'high' value to ensure that obstructions such as rocks or shoals are emphasised. The use of the commonPointRule occurs where a set of geometric objects are involved, such as the triangles in a TIN

The attribute *geometry* contains an instance of GM\_Tin. For each S100\_Triangle the attribute geometry contains GM\_Triangle.

Three vertex points define a triangle. The attribute *geometry* for a S100\_VertexPoint is an instance of GM\_Point. The attribute value contains a record restricted to one entry that defines the coverage value at the vertex (e.g. depth for a bathymetric TIN vertex point).

### 8-7.1.4 S100\_Grid Coverage Spatial Model

The class S100\_Grid Coverage (Figure 8-23) represents a set of values assigned to the points in a 2D grid. Several organizations of grids are available from ISO 19123 with different grid traversal orders, and variable or fixed grid cell sizes. S-100 makes use of two types of grid organizations, the simple quadrilateral grid with equal cell sizes traversed by a linear sequence rule, and the variable cell size quadrilateral grid traversed by a Morton Order sequence rule. This variable cell size grid organization is known as the Quad Tree for a two dimensional grid.

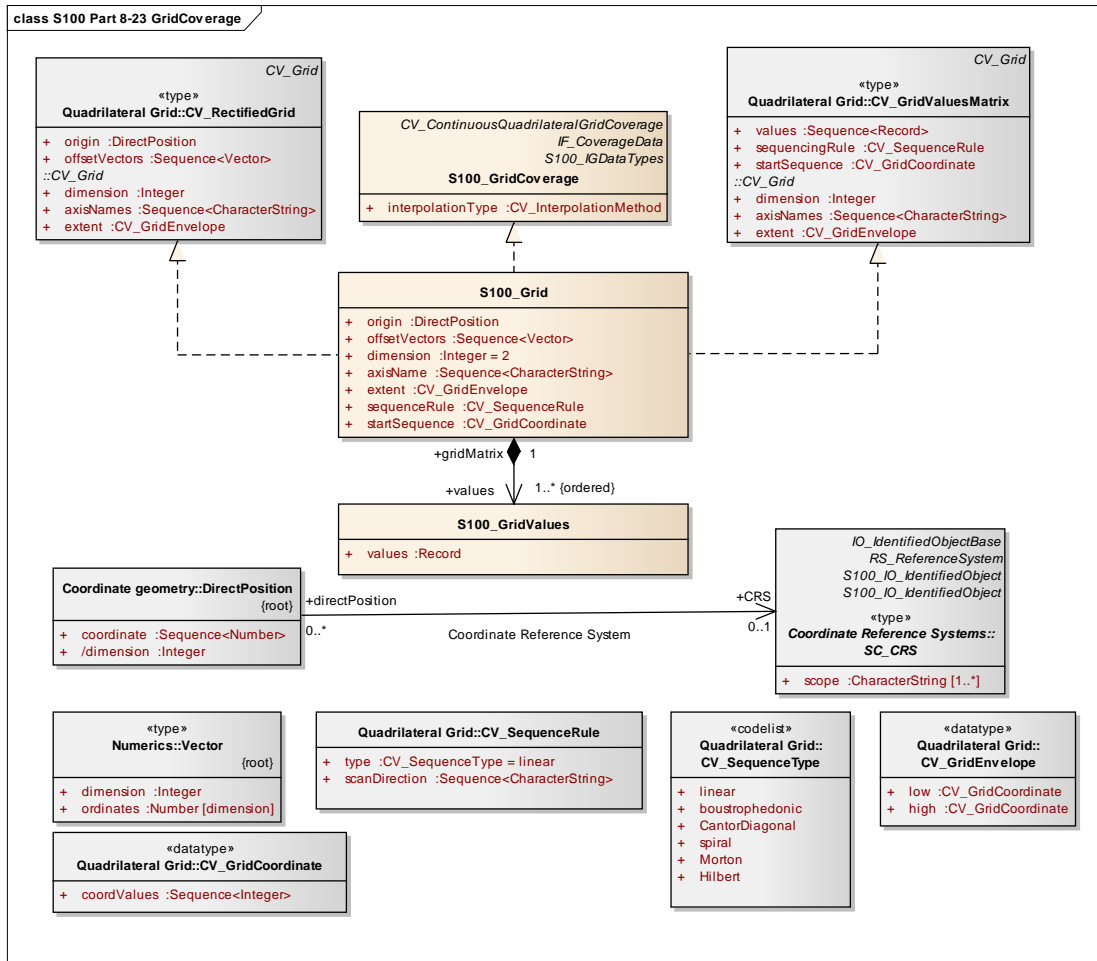


Figure 8-23 - S100\_Grid Coverage

The attribute *interpolationType* describes the interpolation method recommended for evaluation of the S100\_GridCoverage. The interpolation methods available are: Bilinear interpolation, Bicubic interpolation, Nearest-neighbour, and Biquadratic interpolation. These methods are defined in ISO 19123.

The class S100\_Grid is a realization of CV\_RectifiedGrid and CV\_GridValuesMatrix from ISO 19123. The attributes inherit from the classes in ISO 19123. The attribute *dimension* specifies the dimension of the S100 grid. The attribute *axisNames* specifies the names of the grid axes. The attribute *origin* specifies the coordinates of the grid origin with respect to an external coordinate system.

The data type *DirectPosition*, specified in ISO 19107, has an association through the role name *coordinateReferenceSystem* to the class *SC\_CRS* specified in ISO 19111 which specifies the external coordinate reference system.

The attribute *offsetVectors* specifies the spacing between grid points and the orientation of the grid axis with respect to the external coordinate reference system identified through the attribute *origin*. It uses the data type *Vector* specified in ISO/TS 19103.

For simple grids with equal cell sizes the offset vector establishes the cell size. For variable cell size grids (Quad Tree grids) the offset vector establishes the minimum cell size. The actual cell size is included as an attribute in the data record that describes the level of aggregation of the quad structure.

The attribute *extent* specifies the area of the grid for which data are provided. It uses the type *CV\_GridEnvelope* specified in 19123 to provide both the *CV\_GridCoordinates* of the corner of the area having the lowest grid coordinate values and the *CV\_GridCoordinates* of the corner of the area having the highest grid coordinate values. *CV\_GridCoordinate* is specified in 19123.

The attribute *extent* effectively defines a bounding rectangle describing where data is provided. For simple grids with equal cell sizes, if data is not available for the whole area within this rectangle, then padding with null values shall be used to represent areas where no data is available. For variable cell size grids (Quad Tree grids) a characteristic of the Morton Order traversal is that nonrectangular areas may be represented. In this case the attribute *extent* is a bounding rectangle that encloses the area of the grid for which data are provided.

The attribute *sequencingRule* specifies the method to be used to assign values from the sequence of values to the grid coordinates. It uses the data type *CV\_SequenceRule* specified in ISO 19123. Only the values "linear" (for a simple regular cell size grid) and "Morton" (for a Quad Tree Grid) shall be used for data that conforms to this standard.

The sequence rule for a regular cell size grid is simple. When the cells are all of the same size, the cell index can be derived from the position of the Record within the sequence of Records. For a variable cell size grid the sequence order is more complex. The cell index either needs to be carried with each of the associated record values or it can be calculated based on each cell size.

The attribute *startSequence* identifies a value of *CV\_GridCoordinate* to specify the grid coordinates of the grid point to which the first in the sequence of values is to be assigned. The choice of a valid point for the start sequence is determined by the sequencing rule.

The class *values* shall be a sequence of Records each containing one or more values to be assigned to a single grid point. The Record shall conform to the *RecordType* specified by the *rangeType* attribute of the *GridCoverage* with which the Grid is associated. For simple grids with equal cell sizes the attribute values may be only data values, but for the variable cell size Quad Tree grid the record type shall include an index number and the cell size (aggregation level) for the cell.

For simple grids with equal cell sizes the *sequenceRule* attribute of an *S100\_Grid* equals "linear" and the offset vector establishes the cell size. The attribute *extent* specifies the area of the grid for which data is provided. For variable cell size grids (Quad Tree grids) the *sequenceRule* attribute equals Morton and the offset vector establishes the minimum cell size. The actual cell size is included as an attribute in the data record that describes the level of aggregation of the quad structure. The attribute *extent* specifies a bounding rectangle within which data is provided. Which cells are included in the data set is determined from the Morton ordered sequence of cells.

## 8-7.2 Rectified or Georeferencable Grids

The model given below in Figure 8-24, shows that a Grid can be of two types Rectified or Georeferencable and that the Grid Value matrix is a subtype of the general grid object. The Grid Value Matrix may have several different sequence rules. These are given in a codelist of sequence type. Only linear and Morton order are used in this document.

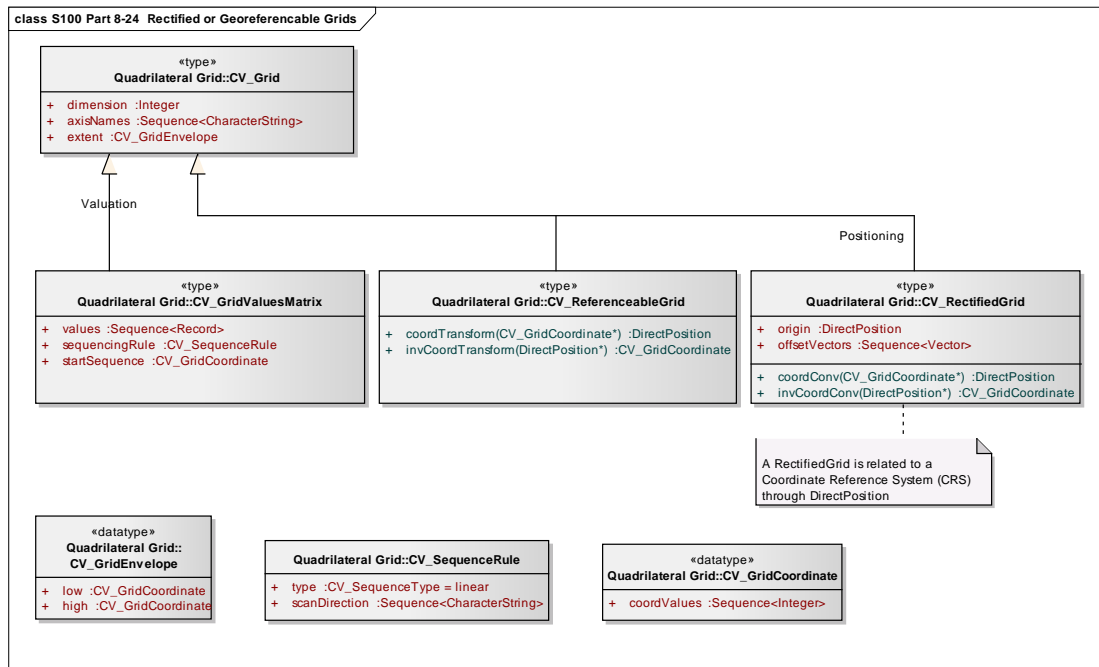


Figure 8-24 - Rectified or Georeferencable Grids

The attribute *dimension* specifies the dimension of the S100\_Grid.

The attribute *axisNames* specifies the names of the grid axes.

The attribute *extent* specifies the area of the grid for which data are provided. It uses the type CV\_GridEnvelope specified in 19123 to provide both the CV\_GridCoordinates of the corner of the area having the lowest grid coordinate values and the CV\_GridCoordinates of the corner of the area having the highest grid coordinate values. CV\_GridCoordinate is specified in 19123.

The attribute *extent* effectively defines a bounding rectangle describing where data is provided.

The attribute Values of the CV\_GridValuesMatrix class defines a sequence of records. These are described using the S100\_GridValues class.

The attribute *sequencingRule* specifies the method to be used to assign values from the sequence of values to the grid coordinates.

The attribute *startSequence* identifies a value of CV\_GridCoordinate to specify the grid coordinates of the grid point to which the first in the sequence of values is to be assigned.

A Rectified Grid is related to the Coordinate Reference System through the attribute Direct Position.

A Referencable Grid may be related to a Coordinate Reference System through a Transform operation.

## 8-8 Data Spatial Referencing

Spatial referencing for gridded data and for point set data and TIN data are handled differently. Point set data includes a coordinate direct position for each point in the point set. TIN data includes a point at each vertex of a TIN triangle. Spatial referencing of direct positions is described in ISO 19111 Spatial referencing by coordinates, and is the same for point set, and TIN data as it is for other types of vector data. Gridded data references the grid as a whole.

## 8-8.1 Gridded Data Spatial Referencing

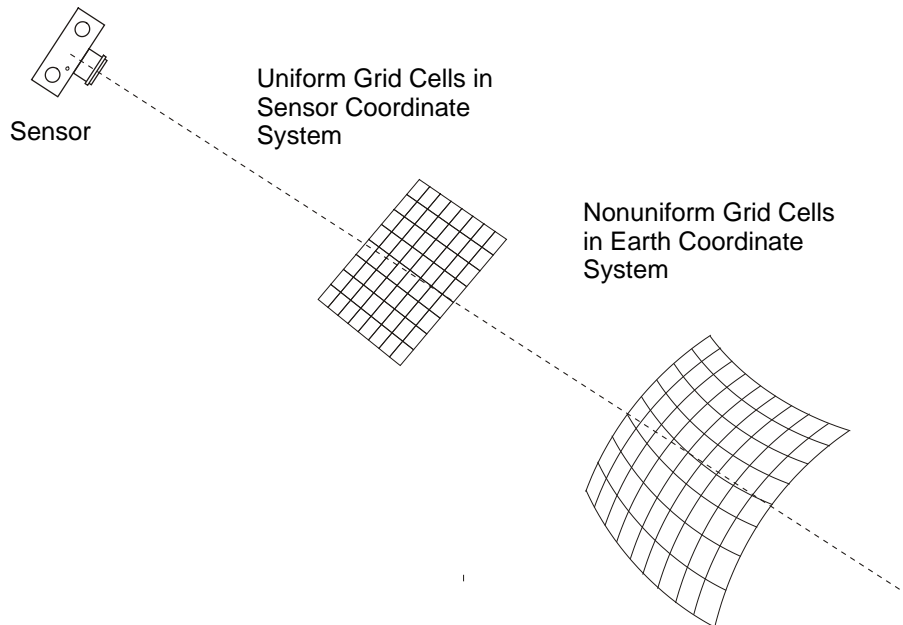
The two spatial properties of gridded data describe how the spatial extent was tessellated into small units and spatial referencing to the earth. The ISO 19123 standard indicates that a grid may be defined in terms of a coordinate reference system. This requires additional information about the location of the grid's origin within the coordinate reference system, the orientation of the grid axes, and a measure of the spacing between the grid lines. A grid defined in this way is called a rectified grid. If the coordinate reference system is related to the Earth by a datum, the grid is a georectified grid. The essential point is that the transformation of grid coordinates to coordinates of the external coordinate reference system is an affine transformation. The class SC\_CRS is specified in ISO 19111. A referenceable grid is one that can be converted to a rectified grid by a coordinate transform.

### 8-8.1.1 Georectified

*Georectified* gridded data is *uniformly spaced* gridded data. Any cell in a georectified gridded data can be uniquely geolocated, given the cell spacing, grid origin and orientation. In most georectified gridded data, cell size is constant across the whole coverage and also equates to the cell spacing. (Note, however, that uniformly spaced gridded data may be uniformly spaced in terms of image coordinates, and not geolocatable.) For georectified gridded data, information as simple as the map coordinate values of any two cells not in the same row and column can geolocate all cells in the coverage to the map coordinate system, since cell spacing, grid origin and orientation can be derived from the coordinates of the two cells.

It should be pointed out that the cell spacing (i.e., cell size) in the above definition is the distance measured at the map projection coordinate system. Uniform spacing in a map coordinate system may not necessarily indicate equal spacing on the earth's surface, depending on the map projection selected. For example, a cell size of 0.1 degree longitude in the geographic coordinate system (i.e. lat/long) corresponds to different surface distances in kilometres at high and low latitudes.

The term "uniform spacing" means that there is equal spacing in some defined coordinate system. "Regular spacing" means that there is some function that equates location to cell spacing.



**Figure 8-25 - Non Uniform Spacing of Grid Cells**

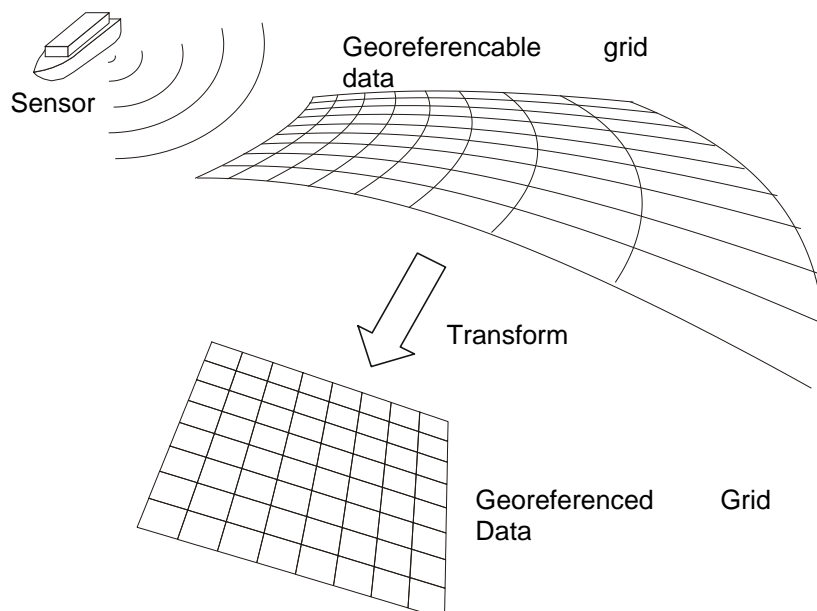
### 8-8.1.2 Ungeorectified

*Ungeorectified* gridded data is geospatial gridded data whose cells are non-uniformly spaced in any geographic/map projection coordinate system. Therefore, the location of one cell in an ungeorectified gridded data cannot be determined based on another cell's location.

Ungeorectified gridded data can be further classified into *georeferenced* and *georeferencable* subclasses, depending on whether information is provided with a data set that allows determination of the geolocation of a cell.

### 8-8.1.3 Georeferenced

*Georeferenced* gridded data is gridded data whose cell locations can be uniquely determined through certain geolocating algorithms, such as warping, using information provided with the data. Most raw remote sensing data and raw hydrographic sonar data are in the georeferencable form.



**Figure 8-26 - Georectified Data**

#### 8-8.1.4 Georeferencable

Georeferencable gridded data is ungeorectified gridded data that does not include any information that can be used to determine a cell's geographic coordinate values, for example, a digital perspective aerial photograph without georectification information included. (An aerial photograph can be georeferenced through a set of ground control points.)

The difference between georectified and georeferenced data is that cell spacing is constant in a georectified data while it may be variable in georeferenced data. In georectified data, the location of any cell can be determined given the data's cell spacing, grid orientation and the coordinates of any one cell. In georeferenced data, there is no predefined association between one cell's location and that of another; each cell's location might be independently calculated. Georectified gridded data are normally obtained from georeferenced data through georectification (also called geometric correction). The georectification process involves two steps. The first step is to calculate the grid coordinates (e.g. row and column) of regularly spaced cells located at the map coordinate  $x, y$ . This step is called *coordinate mapping*. The second step is to assign the cell with an attribute value based on the attribute values at the corresponding and neighbouring grid coordinates. This step is called *resampling*. Spatial referencing information for imagery data is carried as metadata.

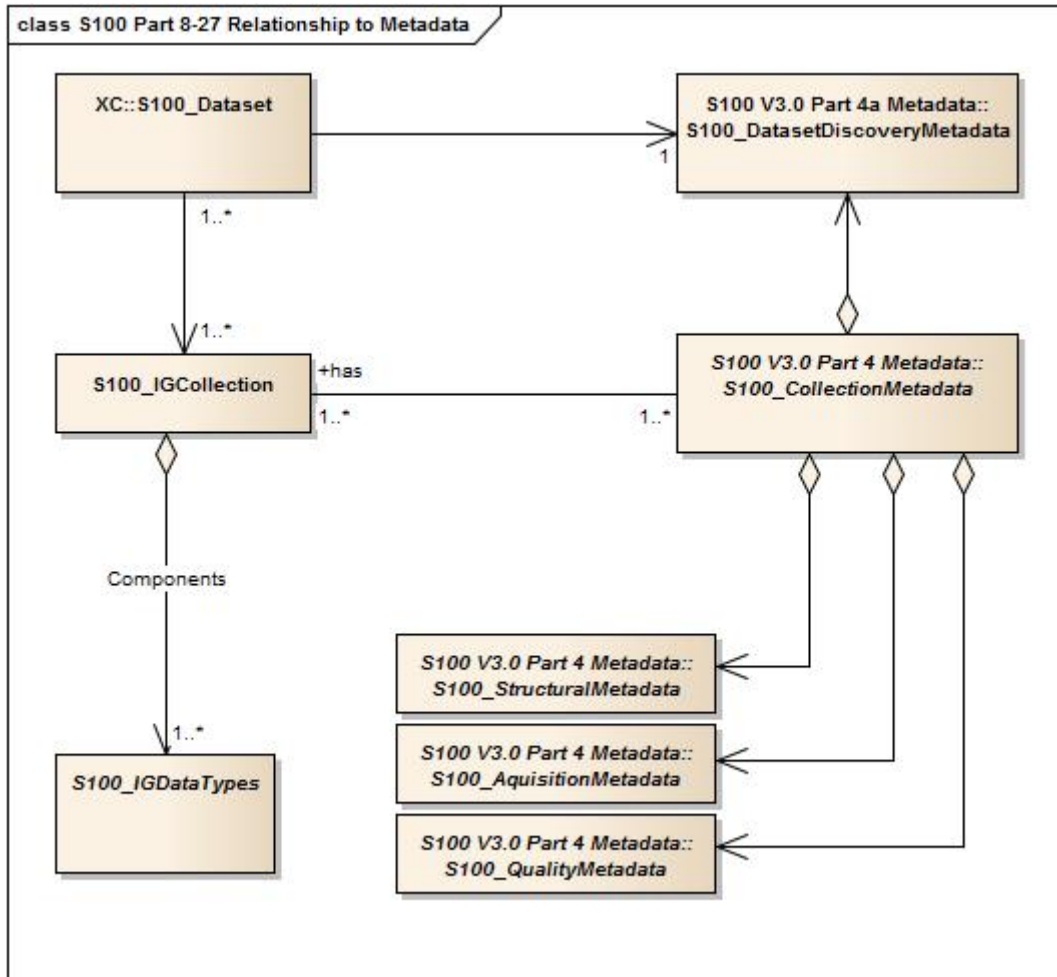
#### 8-8.2 Point Set Data and TIN Triangle Vertex Spatial Referencing

Point sets and TIN triangles are described in the ISO Spatial Schema standard 19107, which has been profiled as part of S-100. Each point in a point set is located by a direct position. The spatial referencing system that relates to the direct positions in the set is referenced by the spatial schema, through the same SC\_CRS object.

#### 8-8.3 Imagery and Gridded Data Metadata

The general structure for imagery and gridded data given in Figure 8-3 shows that metadata is one of the primary components of an imagery and gridded data set. A gridded data set consists of attribute data contained in a grid value matrix and associated metadata. Everything except for the actual grid cell attributes is metadata. Some of the metadata is structural, such as the metadata required to define the geometric structure or spatial referencing, while other metadata describes the meaning of the data set. Some of the structural metadata will be carried as attributes of the Grid Value Matrix Object. Figure 8-27 is a model showing the relationship to metadata for all coverage data. ~~This figure is a generalization of ISO 19102-2.~~





Fig

ure 8-27 – Relationship to Metadata

The metadata for all types of geographic data is covered in the metadata standard ISO 19115 Metadata. This standard includes mandatory identification metadata that describes the data set. This is called Catalog or Discovery metadata. It also includes some metadata describing the content of a data set. This is particularly true at the feature level. Much of the metadata corresponding to vector based geometric data does not apply to imagery and gridded data. The metadata elements in 19115 are used where possible to address the requirements for Imagery, Gridded and Coverage data. Some basic imagery metadata elements are already defined in 19115. Other metadata elements primarily related to acquisition and processing are addressed in ISO 19115-2 Geographic information - Metadata - Part 2: Extensions for imagery and gridded data. The minimum amount of metadata required to describe a coverage data is addressed in 19115. The details of sensor models and their associated data models and metadata are provided in ISO 19130 Geographic information - Sensor and data models for imagery and gridded data. Metadata for S-100 is given in Part 4. The specific metadata for S-100 Imagery and Gridded Data is shown in Appendix 8-D.

### 8-8.4 Quality

The general concept for handling quality in the ISO 19100 series of standards is defined in the ISO 19113 “Quality principles”. The procedures to evaluate quality are defined in the ISO 19114 “Quality evaluation procedures”. ISO 19138:2006 “Data quality measures” provides a definitive set of measures. The metadata quality elements from ISO 19115:2003 have been moved to a new standard ISO 19157:2013 Geographic information -- Data quality.

The ISO 19129 standardizes quality aspects that are specific for imagery, gridded, and coverage data. The testing of the quality according to this standard is model based. The

quality measures are attributes or constraints of the classes of the model. Appendix 8-C shows the proposed top-level classes of the quality model.

## **8-9 Imagery and Gridded Data Portrayal**

The mechanism for portrayal is out of scope for this component of S-100. It is described in the Portrayal component of S-100 Part 9. The basic mechanism for feature centric rule based portrayal is given in ISO 19117 "Portrayal". However, certain information may need to be carried with a set of imagery and gridded data to support external portrayal mechanisms.

## **8-10 Imagery and Gridded Data Encoding**

Details of encoding are out of scope of this document except for the identification of "picture/image" coding standards and associated data coding standards. That is, relation to ISO/IEC JTC1/SC24 (computer graphics and image processing) concerning the ISO 12087-5 Basic Imagery Interchange Standard BIIF and ISO 15948 Portable Network Graphics (PNG) and ISO/IEC JTC1/SC29 (Coded representation of picture, audio and multimedia/hypermedia information) concerning the ISO 15444 JPEG 2000 standards for "picture/image" and ISO 19118 (Geographic Information – Services). A reference to other existing standards for encoding image/gridded data such as CEOS, HDF-EOS, GeoTIFF, and other specifications is required to ensure backward compatibility.

## **8-11 Spatial Schema for Point Sets**

The spatial schema for point sets for four types of imagery and gridded data are described in this section of S-100. An application schema for point sets is described in the S-100 spatial schema section Part 7 clause 7.5.2.19.

### **8-11.1 Gridded data**

This application schema defines a quadrilateral grid coverage with associated metadata. The metadata is generically referenced to ISO 19115 and 19115-2. A specific choice of metadata has not been made in this schema. This schema can serve for both "matrix" and "raster" data [see Appendix 8-D] dependent upon the metadata chosen.

The gridded data consists of a single feature - the "image" or "matrix" together with associated metadata taken from MD\_Metadata (or MI\_Metadata). The CV\_Coverage serves as the spatial attribute of the gridded data set. It defines an area that is "covered" by the coverage function. For the continuous coverage defined in this application schema, the coverage function returns a value for every point in the area covered based on an interpolation function. The Grid Value Matrix is a set of values which drives the interpolation function. In this case the value matrix is a grid traversed by a linear scan (x,y) traversal rule. The spatial referencing is defined by the coordinate reference system. This template application schema supports the majority of imagery and gridded data applications.

This class inherits all the attributes and relations of its parent classes of CV\_Coverage, CV\_ContinuousCoverage and CV\_ContinuousQuadrilateralGridCoverage.

### Figure 8-28 - Template Application Schema for a Quadrilateral Grid Coverage

#### 8-11.2 Scanned Image

This application schema defines a grid coverage with associated metadata for the use of supporting a scanned paper chart in compliance with S-61. The model is the same as that shown in figure 8-28, except that the metadata is defined more precisely.

The following table assigns the metadata identified in S-61 to the metadata classes in ISO 19115.

**Table 8-2 — S-61 Metadata in terms of ISO 19115**

S-61	ISO 19115 class
Producing Agency	MD_Metadata - contact - CI_ResponsibleParty (including organization name, contact info and role of producing agency)
	MD_Metadata - identificationInfo - MD_Identification - purpose - "Raster Nautical Chart"
	MD_Constraints_useLimitation
	MD_Constraints_MD_LegalConstraints
RNC number	MD_Identification - citation - CI_Citation - identifier
Chart identifier	LI_Lineage - LI_Source - sourceCitation - CI_Citation - identifier
RNC edition date	MD_Metadata - dateStamp - Date
Chart edition date	LI_Lineage - LI_Source - sourceCitation - CI_Citation - edition
Last update or Notice to Mariner applied	LI_Lineage - LI_Source - SourceStep - LI_ProcessStep_dateTime
	MD_DataIdentification - topicCategory - TopicCategoryCode - "2" (grid)
	MD_DataIdentification - SpatialRepresentationType - SpatialRepresentationTypeCode - "oceans"
Chart scale	MD_ReferenceSystem
Orientation of North	MD_ReferenceSystem
Projection and projection parameters	MD_ReferenceSystem
Horizontal Datum	MD_ReferenceSystem
Horizontal Datum shift	MD_ReferenceSystem
Vertical datums	MD_ReferenceSystem
Depth and Height units	MD_ReferenceSystem - EX_VerticalExtent - unitOfMeasure
Pixel Resolution	MD_DataIdentification - spatialResolution - MD_Resolution -
Transform to allow geographic positions to be converted to RNC coordinates	MD_ReferenceSystem
Colour palettes for daytime, nighttime and dusk	MD_PortrayalCatalogueReference
information to handle notes, diagrams and marginalia	Notes and textual marginalia may be captured as MD_MetadataExtensionInformation, whereas diagrams must be handled by reference to an associated data file containing the diagram.
source diagram	Textual description of source may be captured as MD_MetadataExtensionInformation, whereas a source diagram must be handled by reference to an associated data file containing the diagram.
update metadata including: - producer of update, - update number, - date, - identifier of which RNC to which it applies, - chart edition to which it applies, - changes to metadata, and - information so it can be applied automatically	MD_MaintenanceInformation together with MD_Identification

### 8-11.3 Variable Cell Size Grid

This application schema describes a grid of variable cell size using the capability for variable cell size grids described in ISO 19123. The traversal order is the Morton order in order to permit support of three (or more) dimensions. This is of particular use for hydrographic data where large volumes of sonar data results in extensive bottom cover in a 3D grid, but where the cells of similar depth can easily be aggregated.

The application schema given in Figure 8-27 applies with minor changes. The type of grid changes to a CV\_ContinuousCoverage

This class inherits all the attributes and relations of its parent classes of CV\_Coverage, CV\_ContinuousCoverage and CV\_ContinuousQuadrilateralGridCoverage

For the attribute values, the first value of the Record, for each grid cell in the matrix is the aggregation level

**Figure 8-29 - Template Application Schema for a Riemann Grid Coverage**



#### 8-11.4 Feature Oriented Image

All gridded data sets are feature oriented, in that a coverage is a subtype of a feature. That is an entire gridded data set can be considered to be a single feature. A feature structure can be applied to gridded data in two different ways. First, a discrete coverage can carry a feature code as an attribute. For example, a coverage corresponding to the postal code system will have discrete values for each postal code, yet still cover the country completely. The only difference in the application schema is a relationship between the discrete coverage and the feature. This is shown in Figure 8-30.

#### Figure 8-30 - Feature Oriented Discrete Coverage

The second method of establishing a feature structure is to develop a composite data set that contains many separate but adjoining coverages. The coverages may be continuous or discrete. This is very much like the way a "vector" data set is composed where each feature has its own geometry and attributes. In fact vector data may be mixed with coverage data in the same data set. The application schema simply allows multiple instances of features.

Geometric elements such as grids may be shared between multiple features, and features may be related by composition or other relationships as allowed in the general feature model of ISO 19109. A complex feature may include both a continuous grid coverage and vector data such as a polygonal boundary. A feature oriented data set may contain both a continuous coverage of the ocean as collected by sonar, and point and line features corresponding to navigational aids. Topological primitives may relate all of the features. This allows for some interesting and useful structures.

A Raster Nautical Chart may include additional vector data describing the navigational aids, hazards and danger zones, which is not "visible" in that it is not portrayed, but which is active in the use of the Raster Nautical Chart, so a ship can determine whether it is within a danger zone, or perform some other ECDIS-like functions.

See Appendix 8-F for additional information about Feature Oriented Gridded Data.



## Appendix 8-A

### Abstract Test Suite (normative)

#### 8-A-1. Quadrilateral grid

- 1) Test Purpose: Verify that an application schema instantiates the classes defined in ISO 19123 of CV\_Grid, CV\_GridPoint, CV\_GridCell, CV\_GridValuesMatrix, CV\_GridPointValuePair, CV\_DiscreteGridPointCoverage, or CV\_ContinuousGridCoverage, and CV\_GridValueCell with their specified attributes, operations, associations and constraints, in the context of the classes S100\_GridCoverage, S100\_Grid and S100\_GridValues as defined in this standard
- 2) Test Method: Inspect the documentation of the application schema or profile.
- 3) Reference: ISO 19123, Clause 8.
- 4) Test Type: Capability.

#### 8-A-2. Scanned Image

- 1) Test Purpose: Verify that an application schema for Raster Scan Image satisfies the requirements of A.1; that it includes the metadata elements identified in Table 8-2.
- 2) Test Method: Inspect the documentation of the application schema or profile.
- 3) Reference: ISO 19115, IHO S-61.
- 4) Test Type: Capability.

#### 8-A-3. TIN Coverage

- 1) Test Purpose: Verify that an application schema for TIN Coverage instantiates the classes defined in ISO 19123 of CV\_TINCoverage, CV\_ValueTriangle, and CV\_GridPointValuePair with their specified attributes, operations, associations and constraints, in the context of the classes S100\_TINCoverage, S100\_Triangle and S100\_VertexPoint as defined in this standard.
- 2) Test Method: Inspect the documentation of the application schema or profile.
- 3) Reference: ISO 19123
- 4) Test Type: Capability.

#### 8-A-4. Point Coverage

- 1) Test Purpose: Verify that an application schema for Point Coverage instantiates the classes defined in ISO 19123 of CV\_DiscretePointCoverage, and CV\_PointValuePair, with their specified attributes, operations, associations and constraints, in the context of the classes S100\_PointCoverage and S100\_VertexPoint as defined in this standard.
- 2) Test Method: Inspect the documentation of the application schema or profile.
- 3) Reference: ISO 19123
- 4) Test Type: Capability.

#### 8-A-5. Point Set

- 1) Test Purpose: Verify that an application schema for Point Set instantiates the classes defined in ISO 19107 of GM\_Point, with its specified attributes, operations, associations and constraints, in the context of the classes S100\_PointSet and S100\_Point as defined in this standard.
- 2) Test Method: Inspect the documentation of the application schema or profile.
- 3) Reference: ISO 19107
- 4) Test Type: Capability.

**8-A-6. Variable Cell Size Grid**

- 1) Test Purpose: Verify that an application schema for Variable Cell Size instantiates the classes defined in ISO 19123 of CV\_Grid, CV\_GridPoint, CV\_GridCell, CV\_GridValuesMatrix, CV\_GridPointValuePair, CV\_DiscreteGridPointCoverage, or CV\_ContinuousGridCoverage, and CV\_GridValueCell with their specified attributes, operations, associations and constraints, with the CV\_ContinuousCoverage CV\_InterpolationMethod attribute set to NearestNeighbour and the CV\_GridValuesMatrix CV\_SequenceRule attribute set to (x,y) Morton.
- 2) Test Method: Inspect the documentation of the application schema or profile.
- 3) Reference: ISO 19123
- 4) Test Type: Capability.

**8-A-7. Feature Oriented Image Discrete Coverage**

- 1) Test Purpose: Verify that an application schema for Feature Oriented Image that uses a discrete coverage instantiates the classes defined in ISO 19123 of CV\_Grid, CV\_GridPoint, CV\_GridCell, CV\_GridValuesMatrix, CV\_GridPointValuePair, CV\_DiscreteGridPointCoverage, CV\_DiscreteCoverage, and CV\_GeometryValuePair with their specified attributes, operations, associations and constraints.
- 2) Test Method: Inspect the documentation of the application schema or profile.
- 3) Reference: ISO 19123, 19109
- 4) Test Type: Capability.

**8-A-8. Feature Oriented Image in a Multi-feature Environment**

- 1) Test Purpose: Verify that an application schema instantiates the classes defined in ISO 19123 of CV\_Grid, CV\_GridPoint, CV\_GridCell, CV\_GridValuesMatrix, CV\_GridPointValuePair, CV\_DiscreteGridPointCoverage, or CV\_ContinuousGridCoverage, and CV\_GridValueCell with their specified attributes, operations, associations and constraints, and that multiple features are permitted with separate CV\_Coverages or GM\_Objects.
- 2) Test Method: Inspect the documentation of the application schema or profile.
- 3) Reference: ISO 19123, 19109, 19107
- 4) Test Type: Capability

## Appendix 8-B

### Terminology

(informative)

The terminology used in S-100 aligns with the terminology used in the ISO 19100 suite of standards and it is different to that used in the previous editions of S-57. The previous editions of S-57 used the terms “raster” and “matrix” to address images and data described by organized sets of attribute values. The ISO 19100 suite of standards has a more rigorous definition of terms, but these new terms include much more that is normally thought of as “Raster” or “Matrix” data. Unfortunately current terms in this field have been used with broad overlapping meanings and the terminology can be confusing.

One of the most misused terms is “raster”. Technically the term describes the row by column scanning of a regular rectangular grid, such as the raster scan of a television screen. A raster is a type of a grid. However, often the term is used in a very broad sense to mean most, but not all types of data that cover an area. S-100 now makes use of the term “raster” in its more precise technical sense as a traversal method for a grid of data.

“matrix” is a term that is also used in different ways in different contexts. It is sometimes colloquially used to address all gridded data that corresponds to measurements from non-imaging sensors. But what is an imaging sensor? What is an image? Anything that can be “seen” is thought of as being an image. But a graph of measured data such as elevations, even a two-dimensional graph of data, can be seen. In fact visualization is the purpose of graphing. The term “matrix” also has a mathematical meaning of being an organized set of numbers. The current colloquial meaning of the term “matrix” has been abandoned in this edition of S-100, and the mathematical meaning of an ordered set of numbers is retained as the meaning for the word.

ISO begins defining its terminology by defining a “coverage”. In TC211, a coverage is defined as a “function to return one or more feature attribute values for any direct position within its spatiotemporal domain”. For a continuous coverage any position in the spatiotemporal domain has a value. A coverage function is basically an interpolation function over a set of grid points or other points covering an area. This makes a coverage the inverse of what is normally thought of as a set of gridded data. Data collected from a sensor creates a values matrix that drives the coverage function. This set of values may be organized in several ways. The simplest is a regular grid, but there may be other organizations of grids such as tiled grids or irregular shaped grids. There may even be grids with variable size cells in multi-dimensions that have been shown to be quite effective in handling hydrographic sounding data. The ISO 19123 standard defines a Grid Value Matrix, TIN Value Triangle, Segmented-Curve Value Curves, and Thiessen Value Polygons as the base elements for the set of data sampled from a sensor. This component of S-100 only needs the concept of a grid value matrix, and does not need to address Segmented Curves, or Thiessen Polygons.

The terms Imagery, Gridded and Coverage data are not mutually exclusive terms. Imagery is a type of Gridded data and Gridded data is a type of Coverage data. Coverage is the broad term. Grid describes one organization of the matrix of data supporting a coverage function. An image is data that may be “viewed”.

S-100 needs to use terminology in alignment with ISO and other external standards. However it also needs to recognize the uses of terms in previous editions of S-57. A raster is a grid traversal method. Therefore “Raster Image Data” means data organized as a set of grid value matrix points representing an image. “Raster Image Data” corresponds generally to the term Raster Data as used in S-57 edition 3. Gridded data is all data organized as a set of grid value matrix points. Therefore “Gridded Data” corresponds generally to the term Matrix Data as used in S-57 edition 3.

## Appendix 8-C

### Quality Model for Imagery and Gridded Data (informative)

The following is a list of quality elements test procedures from ISO 19129 that addresses imagery and gridded data.

#### **8-C-1. Top-level classes of the quality-model**

General image quality  
 Visual inspection and evaluation of image geometry  
 Analytical inspection and evaluation of image geometry  
 Visual inspection and evaluation of image radiometry  
 Analytical inspection and evaluation of image radiometry

The following listings are non-exhaustive listings of the subclasses of the quality model.

#### **8-C-2. Class General image quality**

check parameters affecting the quality (data compression etc.)  
 make test scanning or test imaging

#### **8-C-3. Class Visual inspection and evaluation of image geometry**

check number of channels (black&white, colour, multispectral, etc.)  
 check edge-matching  
 check event of blurring  
 check rectification errors  
 check "pixel-stretching"  
 check overlay with vector data (other mapping data, map-frame)  
 check overlay with other raster or gridded data  
 identify source of data  
 inspect documentation of the quality of the sensor or the scanner (calibration data)  
 inspect documentation of previous processing step (image enhancements)  
 check resolution of imaged test patterns

#### **8-C-4. Class Analytical inspection and evaluation of image geometry**

check seam lines of mosaics  
 check colour stability / homogeneity / balance  
 check grade of illumination of the image (hot spot)  
 check histogram  
 check coloured fringes along lines with high contrast

#### **8-C-5. Class Visual inspection and evaluation of image radiometry**

calculate geometric residuals at checkpoints in 2D and/or in 3D  
 calculate residuals in range at checkpoints

#### **8-C-6. Class Analytical inspection and evaluation of image radiometry**

calculate contrast  
 calculate brightness

## Appendix 8-D Metadata (informative)

Metadata for S-100 is taken where possible from the ISO 19115 Metadata standard to ensure a high level of compatibility with other standards based on the same metadata standard. This metadata has been organized into a number of packages. The following is a list of the packages defined in ISO 19115.

**Relationship between packages of metadata and metadata entities**

Package	Entity
Metadata entity set information	MD_Metadata
Identification information	MD_Identification
Constraint information	MD_Constraints
Data quality information	DQ_DataQuality
Maintenance information	MD_MaintenanceInformation
Spatial representation information	MD_SpatialRepresentation
Reference system information	MD_ReferenceSystem
Content information	MD_ContentInformation
Portrayal catalogue information	MD_PortrayalCatalogueReference
Distribution information	MD_Distribution
Metadata extension information	MD_MetadataExtensionInformation
Application schema information	MD_ApplicationSchemaInformation
Extent information	EX_Extent
Citation and responsible party information	CI_Citation CI_ResponsibleParty

ISO TC211 has also completed ISO 19115-2 Geographic information - Metadata - Part 2: Extensions for imagery and gridded data. It contains additional packages for MI\_AcquisitionInformation, Lineage (Source and Process), Quality result for Coverage (QE\_CoverageDescription) and usability (QE\_Usability) that are relevant for the description of Imagery and Gridded data in S100.

The MI\_AcquisitionInformation package provides details specific to the acquisition of imagery and gridded data. It contains:

- 1) MI\_Instrument, designations of the measuring instruments used to acquire the data;
- 2) MI\_Operation, designations of the overall data gathering program to which the data contribute;
- 3) MI\_Platform, designations of the platform from which the data were taken;
- 4) MI\_Objective, the characteristics and geometry of the intended object to be observed;
- 5) MI\_Requirement, the user requirements used to derive the acquisition plan;
- 6) MI\_Plan, the acquisition plan that was implemented to acquire the data.
- 7) MI\_Event, describes a significant event that occurred during data acquisition. An event can be associated with an operation, objective, or platform pass, and
- 8) MI\_PlatformPass, identifies a particular pass made by the platform during data acquisition. A platform pass is used to provide supporting identifying information for an event and for data acquisition of a particular objective.

The additional classes to address the sources and production processes of particular importance for imagery and gridded data are:

- 1) QE\_CoverageResult is a specified subclass of DQ\_Result and aggregates information required to report data quality for a coverage;
- 2) QE\_Usability is a specified subclass of DQ\_Element used to provide user specific quality information about a dataset's suitability for a particular application;
- 3) LE\_ProcessStep is a specified subclass of LI\_ProcessStep and contains additional information on the history of the algorithms used and processing performed to produce the data. It includes a description of;
  - a) LE\_Processing, which describes the procedure by which the algorithm was applied to generate the data from the source data.;
  - b) LE\_ProcessStepReport which identifies external information describing the processing of the data;
  - c) LE\_Source, which describes the output of a process step.

### **8-D-1. Metadata entity set information (MD\_Metadata) from ISO 19115**

The MD\_Metadata entity is an aggregate of the following entities (which are further explained in the following subclauses):

#### **8-D-1.1. Identification information (MD\_Identification)**

Identification information contains information to uniquely identify the data. It includes information about the citation for the resource, an abstract, the purpose, credit, the status and points of contact. The MD\_Identification entity is mandatory. It contains mandatory, conditional, and optional elements. MD\_Identification is an aggregate of the following entities:

- 1) MD\_Format, format of the data
- 2) MD\_BrowseGraphic, graphic overview of the data
- 3) MD\_Usage, specific uses of the data
- 4) MD\_Constraints, constraints placed on the resource
- 5) MD\_Keywords, keywords describing the resource
- 6) MD\_MaintenanceInformation, how often the data is scheduled to be updated and the scope of the update

#### **8-D-1.2. Constraint information (MD\_Constraints)**

This package contains information concerning the restrictions placed on data. The MD\_Constraints entity is optional and may be specified as MD\_LegalConstraints and/or MD\_SecurityConstraints. The otherConstraint element of MD\_LegalConstraints shall be non-zero (used) only if accessConstraints and/or useConstraints elements have a value of "otherRestrictions", which is found in the MD\_Restriction enumeration.

#### **8-D-1.3. Data quality information (DQ\_DataQuality)**

This package contains a general assessment of the quality of the dataset. The DQ\_DataQuality entity is optional and contains the scope of the quality assessment. DQ\_DataQuality is an aggregate of LI\_Lineage and DQ\_Element. DQ\_Element can be specified as DQ\_Completeness, DQ\_LogicalConsistency, DQ\_PositionalAccuracy, DQ\_ThematicAccuracy and DQ\_TemporalAccuracy. Those five entities represent Elements of data quality and can be further subclassed to the sub-Elements of data quality. Users may add additional elements and sub-elements of data quality by sub-classing DQ\_Element or the appropriate sub-element.

This package also contains information about the sources and production processes used in producing a dataset. The LI\_Lineage entity is optional and contains a statement about the

lineage. LI\_Lineage is an aggregate of LI\_ProcessStep and LI\_Source. The "report" and "lineage" roles of DQ\_DataQuality are mandatory if DQ\_DataQuality.scope.DQ\_Scope.level has a value of "dataset". The "levelDescription" element of DQ\_Scope is mandatory if the "level" element of DQ\_Scope does not have a value of "dataset" or "series". The "statement" element of LI\_Lineage is mandatory if DQ\_DataQuality.scope.DQ\_Scope.level has a value of "dataset" or "series" and the LI\_Lineage roles of "source" and "processStep" are not documented.

The "source" role of LI\_Lineage is mandatory if the "statement" element and the "processStep" role of LI\_Lineage are not documented. The "processStep" role of LI\_Lineage is mandatory if the "statement" element and the "source" role of LI\_Lineage are not documented. Either the "description" or "sourceExtent" element of LI\_Source must be documented.

#### **8-D-1.4. Maintenance information (MD\_MaintenanceInformation)**

This package contains information about the scope and frequency of updating data. The MD\_MaintenanceInformation entity is optional and contains mandatory and optional metadata elements.

#### **8-D-1.5. Spatial representation information (MD\_SpatialRepresentation)**

This package contains information concerning the mechanisms used to represent spatial information in a dataset. The MD\_SpatialRepresentation entity is optional and can be specified as MD\_GridSpatialRepresentation and MD\_VectorSpatialRepresentation. Each of the specified entities contains mandatory and optional metadata elements. When further description is necessary, MD\_GridSpatialRepresentation may be specified as MD\_Georectified and/or MD\_Georeferenceable. Metadata for Spatial data representation are derived from ISO 19107.

#### **8-D-1.6. Reference system information (MD\_ReferenceSystem)**

This package contains the description of the spatial and temporal reference system(s) used in a dataset. MD\_ReferenceSystem contains an element to identify the reference system used. MD\_ReferenceSystem may be subclassed as MD\_CRS, which is an aggregate of MD\_ProjectionParameters and MD\_EllipsoidParameters. MD\_ProjectionParameters is an aggregate of MD\_ObliqueLineAzimuth and MD\_ObliqueLinePoint. MD\_ReferenceSystem is derived from RS\_ReferenceSystem, which can be specified as SC\_CRS, SI\_SpatialReferenceSystemUsingGeographicIdentifiers and TM\_ReferenceSystem. Metadata for Reference system information are derived from ISO 19108, ISO 19111 and ISO 19112.

#### **8-D-1.7. Content information (MD\_ContentInformation)**

This package contains information identifying the feature catalogue used (MD\_FeatureCatalogueDescription) and/or information describing the content of a coverage dataset (MD\_CoverageDescription). Both description entities are subclasses of the MD\_ContentInformation entity. MD\_CoverageDescription may be subclassed as MD\_ImageDescription, and is an aggregate of MD\_RangeDimension. MD\_RangeDimension may additionally be subclassed as MD\_Band.

#### **8-D-1.8. Portrayal catalogue information (MD\_PortrayalCatalogueReference)**

This package contains information identifying the portrayal catalogue used. It consists of the optional entity MD\_PortrayalCatalogueReference. This entity contains the mandatory element used to specify which portrayal catalogue is used by the dataset.

### **8-D-1.9. Distribution information (MD\_Distribution)**

This package contains information about the distributor of, and options for obtaining, a resource. It contains the optional MD\_Distribution entity. MD\_Distribution is an aggregate of the options for the digital distribution of a dataset (MD\_DigitalTransferOptions), identification of the distributor (MD\_Distributor) and the format of the distribution (MD\_Format), which contain mandatory and optional elements. MD\_DigitalTransferOptions contains the medium used for the distribution (MD\_Medium) of a dataset, and is an aggregate of MD\_DigitalTransferOptions. MD\_Distributor is an aggregate of the process for ordering a distribution (MD\_StandardOrderProcess).

The “distributionFormat” role of MD\_Distribution is mandatory if the “distributorFormat” role of MD\_Distributor is not documented. The “distributorFormat” role of MD\_Distributor is mandatory if the “distributionFormat” role of MD\_Distribution is not documented.

### **8-D-1.10. Metadata extension information (MD\_MetadataExtensionInformation)**

This package contains information about user specified extensions. It contains the optional MD\_MetadataExtensionInformation entity. MD\_MetadataExtensionInformation is an aggregate of information describing the extended metadata elements (MD\_ExtendedElementInformation).

### **8-D-1.11. Application schema information (MD\_ApplicationSchemaInformation)**

This package contains information about the application schema used to build a dataset. It contains the optional entity MD\_ApplicationSchemaInformation which is an aggregate of MD\_SpatialAttributeSupplement, which is an aggregate of MD\_FeatureTypeList. The entities contain mandatory and optional elements.

Metadata extensions for Imagery from ISO 19115-2. The work on ISO 19115-2 is still (June 2009) in the development phase. However the general types of extensions have been identified. The following are examples of those extensions.

**MI\_AcquisitionInformation** a new class in the Data Identification Package

- 1) planningPoints
- 2) instrumentIdentification
- 3) platformIdentification
- 4) missionIdentification

**MD\_ImageDescription**

- 1) aerotriangulationReference
- 2) localElevationAngle
- 3) localAzimuthAngle
- 4) relativeAzimuth
- 5) platformDescending
- 6) nadir

Other metadata will derive from the work on ISO 19130 Sensor Models, and any input from IHO. In particular there is a need for input on metadata about hydrographic sounding sensors.



## Appendix 8-E

### Portrayal of Imagery and Gridded Data (informative)

#### 8-E-1. Colour

Imagery and gridded data makes use of RGB or colour coding for the representation of pixel values. When digitizing a synthetic image such as a map or chart the use of a colour map can produce significant advantages in the amount of data, which needs to be communicated. If only a very few colours are used in a printed product, then only that number of colour map entries are required, and subsequently only a few bits are required per pixel to address in the colour map. For example, if a chart used only seven inks when it was originally printed, and if it is possible to distinguish these as seven distinct colours, then a colour map could be constructed which specifies each of these seven colours in terms of their exact colour values. Only 3 bits per pixel would be required to be indexed in the colour map.

#### 8-E-2. Color Systems

Useful systems for image coding are linear RGB (Red Green Blue), nonlinear RGB, nonlinear CMY (Cyan Magenta Yellow), nonlinear CMYK (Cyan Magenta Yellow Black), and derivatives of nonlinear RGB such as YCrCb (Luminosity and Colour components) and HSV (Hue Saturation Value). Numerical values of hue and saturation are not useful in colour image coding, however they are extremely important for colour interpolation and colour tiling. Direct acquisition of luminance requires use of a very specific spectral weighting. However, luminance can also be computed as a weighted sum of red, green and blue components. If three sources appear red, green and blue, and have the same radiance in the visible spectrum, then the green will appear the brightest of the three because the luminous efficiency function peaks in the green region of the spectrum. The red will appear less bright, and the blue will be the darkest of the three.

As a consequence of the luminous efficiency function, all saturated blue colours are quite dark and all saturated yellows are quite light. If luminance is computed from red, green and blue, the coefficients will be a function of the particular red, green and blue spectral weighting functions employed, but the green coefficient will be quite large, the red will have an intermediate value, and the blue coefficient will be the smallest of the three.

Of the aforementioned colour systems, the three best suited for object related raster are RGB, HSV, and YCrCb. RGB separates the Red, Green and Blue components of a given colour. HSV separates a colour into its Hue, Saturation and Value. Saturation is the colourfulness of an area judged in proportion to its brightness. Saturation runs from neutral grey through pastel to saturated colours. Hue is the attribute of a visual sensation according to which an area appears to be similar to one of the perceived colours, red, yellow, green and blue, or a combination of two of them. Value is the same as Intensity, a measure over some interval of the electromagnetic spectrum of the flow of power. Value, in this case, is the linear-light measure. YCrCb separates the Luminosity from the colour components. Luminosity, or Brightness, is the attribute of a visual sensation according to which an area appears to emit more or less light. The two colour components are referred to as the Chrominance (Chrominance Red and Chrominance Blue). Chrominance is calculated as the difference between a colour and a reference white at the same luminance.

HSV is the best for interpolation due to its consistent scalability. YCrCb has better capabilities in compression.

RGB is not the best for aggregated data compression due to its discontinuity within the colour spectrum range. HSV and YCrCb have better compression capability due to their being continuous and consistent in the colour spectrum. YCrCb has better compression, marginally, since it allows the colour elements Cr and Cb to be separate from luminosity Y.

Compression can then operate on the basis of colour elements Cr and Cb rather than being biased by luminosity.

All three colour systems have their individual advantages. RGB as the storage mechanism since most systems are standardized to it. HSV as the mechanism for interpolation and compression due to its consistent scalability. YCrCb can also be used for a compression mechanism since it allows colour elements to be separated from luminosity, allowing a higher compaction ratio, however that impacts interpolation. The HSV value is a percentage value that is spread over the ranges evenly with respect to the individual respective HSV and RGB values that is used as a tolerance for data aggregation.

These three colour systems (RGB, HSV, YCrCb) can be incorporated within the same architecture in separate context. As above, the reasons for this are that RGB as the storage mechanism since most systems have standardized to it, HSV as the mechanism for interpolation due to its consistent scalability, YCrCb for the mechanism compression since it allows colour elements to be separated from luminosity.

Colour codes are stored in a colour lookup table along with their CIE (x, y, Y) reference and RGB intensity values. Both RGB and CIE are different colour systems by which colours may be specified. RGB is a simple system consisting of the intensity of each of the three primary colours Red, Green, and Blue. Note, that these are additive primary colours where Green and Blue make Yellow, that is, the mixing of lights. For subtractive primary colours, such as the mixing of paints, the primary colours are Red, Yellow and Blue, and the mixing of Yellow and Blue make Green. As long as the light frequencies corresponding to Red, Green and Blue are specified, then any colour that can be produced by the mixing of these base colours can be specified in terms of the intensity of the RGB components. The exact frequencies for Red, Green and Blue, the phosphor colours for a CRT, are specified in the Television Standards CCIR Com 11 R 608.

The CIE colour system is a separate colour system based on colourimetric principles. It does not rely on three basis colour primaries, but rather on a two-dimension colour space, in which all colours, even those that cannot be represented on paper or on a CRT, can be described.

The example given above of the selection of only seven colours based on the original inks used on a map or chart is in most cases impractical, because often inks are mixed and print masks are used to represent shades of a colour, such as a light blue being composed of alternate white and blue pixels. Nevertheless in a real map or chart the number of colours is usually limited to under 256 which can be represented in 8 bits. If a colour is a known mixture of two other colour codes, then the proportions of the two or more defined colours included in the mix should be defined in the colour table. For example if Colour 5 in the colour table is a mixture of 33% of Colour 3 and 67% of Colour 1 then these proportions should be defined. The purpose of this is to allow easy modification of the colours for display purposes.

### **8-E-3. Attribute Colour Portrayal**

**Colour Ramps** – Colour Ramps are continuous colour spectra ranging from a specified start and end point. They can cover the complete visible spectrum or a limited component of it. As well, a Colour Ramp can be in grey-scale. Although theoretically continuous, the application of a Colour Ramp necessitates that the portrayal be a discrete representation of the given spectrum. Large or small ranges of data can be compressed or stretched in the process of ramping the attribute values. As well, start and end points can be selected on a given spectrum to aid in the best portrayal of data with limited dynamic range.

**Colour Banding** – Colour Banding is also referred to as Colour Tables. It is a list or table containing discrete colour values and attribute value ranges. For every range of an attribute's value (e.g. 10-20) a specific colour is assigned (e.g. red, or R=255 G=0 B=0). Most often the series of colour assignments follows a progressive path which discretely mimics a ramped colour spectrum, but it is not necessary – there is no need for any progressive pattern.

Colour Tables can be chosen or designed to best portray certain types of data or to highlight specific aspects.

Object Colouring – Colour can also be assigned by object or object type. In this manner, within a given attribute if certain feature types have been made into objects, they can be coloured based wholly on their identity. In this manner, boulders (the object ‘boulder’) could be assigned the colour green (R=0 G=255 B=0), while bridge objects could be assigned some other colour (e.g. R=123 G=55 B=234). This is similar to the Colour Table approach, except that colours are assigned to individual objects and not an attribute value or range. As well, several attributes can be used to define a given object and thus colouring is based indirectly on multiple attributes.

Within a given visualization, data can be portrayed using any of these approaches. As well, combinations can be used. As an example, bathymetric depth data could be coloured using a Colour Ramp of the blue spectrum, while objectified boulders are assigned an object colour and portrayed as yellow (R=0 G=255 B=255).

## Appendix 8-F

### Feature Oriented Images

(informative)

The Spatial Object in the S-100 model and in the ISO model can represent either Vector data or Imagery, Gridded or Coverage data. Both make reference to an externally defined Spatial Referencing System. Also both are feature oriented.

Most people do not think of Imagery, Gridded or Coverage data as being feature oriented. At the minimum an image or a set of gridded measurements or a TIN coverage can be considered as a single feature, so in essence such data is feature oriented. But this is the minimum case. It is possible to include in an imagery, gridded or coverage data set a data structure that could group pixels to identify features. For example an attribute could be included with each pixel that carried a feature ID number. This would allow one to identify certain features as being a particular feature type. In an image data set corresponding to a scanned paper chart, one could mark sets of pixels as representing various hydrographic features. There are other more efficient methods of carrying such feature ID attribute data for an image than adding bits to each pixel. There is no obligation to build such sophisticated feature oriented imagery data sets, but both S-100 and the ISO standards allow them to be built if needed. This can be very important for the fusion of bathymetric sensor data represented as an image together with vector chart data.

This appendix discusses the utility of feature oriented images and gives examples. The structures to support feature oriented images are very simple and are part of the application. It is not obvious that a single reference within the data model allows for an entire capability, so this informative appendix illustrates how that capability can be implemented and used.

All gridded data sets are feature oriented, in that a coverage is a subtype of a feature. That is, an entire gridded data set can be considered to be a single feature. A feature structure can be applied to gridded data in two different ways. First, a discrete coverage can carry a feature code as an attribute. For example, a coverage corresponding to the postal code system will have discrete values for each postal code, yet still cover the country completely. The only difference in the application schema is a relationship between the discrete coverage and the feature. This is shown in Figure 8-F 1.

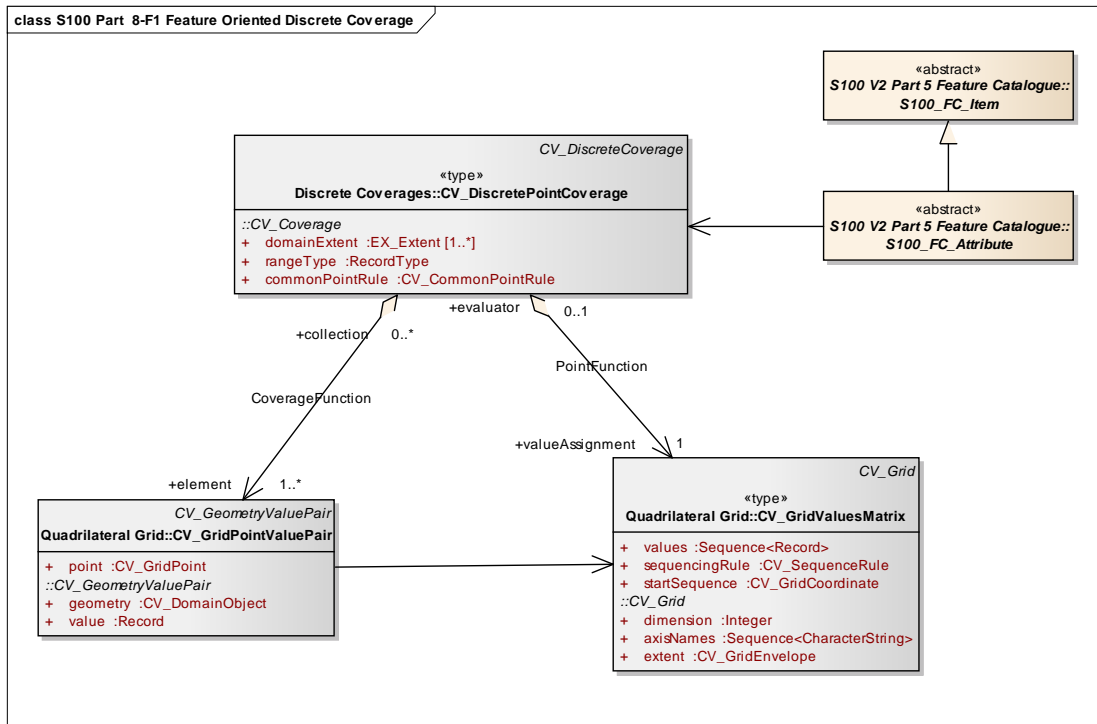
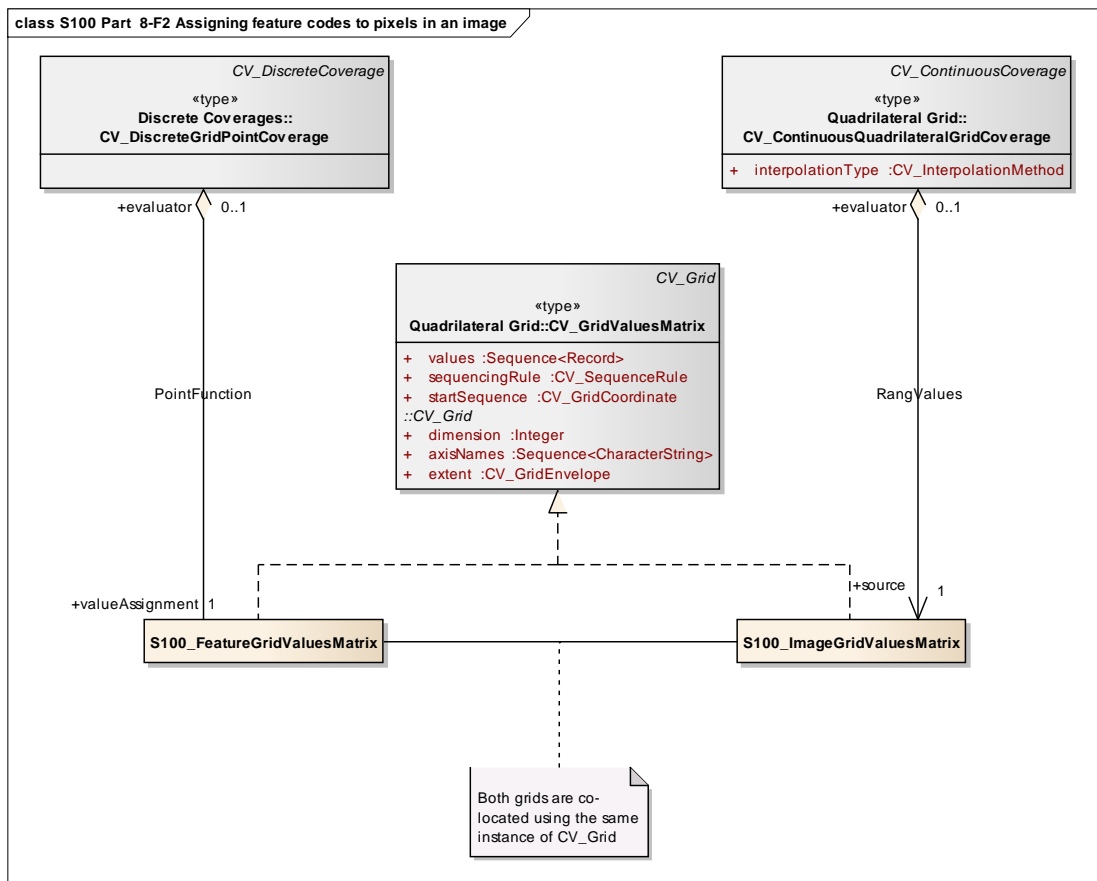


Figure 8-F-1 – Feature Oriented Discrete Coverage

The model shown in Figure 8-F-2 illustrates the collocation of two grids, supported by one grid value matrix to achieve the assignment of feature ID to specific cells. The discrete coverage allows for the assignment of feature codes to Grid Value Matrix entities and the continuous coverage allows one to handle the image.



**Figure 8-F-2 – Assigning feature codes to pixels in an image.**

The second method of establishing a feature structure is to develop a composite data set that contains many separate but adjoining coverages. The coverages may be continuous or discrete. This is very much like the way a "vector" data set is composed where each feature has its own geometry and attributes. In fact vector data may be mixed with coverage data in the same data set. The application schema simply allows multiple instances of features.

Geometric elements such as grids may be shared between multiple features, and features may be related by composition or other relationships as allowed in the general feature model of ISO 19109. A complex feature may include both a continuous grid coverage and vector data such as a polygonal boundary. A feature oriented data set may contain both a continuous coverage of the ocean as collected by sonar, and point and line features corresponding to navigational aids. Topological primitives may relate all of the features. This allows for some interesting and useful structures. For example, a scanned paper map represented as a gridded data set may include additional vector data describing the roads and other features on the scanned map, which is not "visible" in that it is not portrayed, but which is active in that a user might query the name of a feature or traverse along a road on what would appear to be a gridded data set.

# **S-100 – Part 9**

## **Portrayal**

## Contents

9-1	Scope .....	1
9-2	Conformance .....	1
9-3	Normative references .....	1
9-4	Symbols, notation and abbreviated terms .....	1
9-4.1	Abbreviations .....	1
9-4.1.1	annotation .....	1
9-4.1.2	feature portrayal function .....	1
9-4.1.3	portrayal .....	1
9-4.1.4	portrayal catalogue .....	1
9-4.1.5	portrayal context .....	1
9-4.1.6	portrayal function .....	1
9-4.1.7	portrayal rule .....	1
9-4.1.8	render .....	1
9-4.1.9	symbol .....	1
9-5	Portrayal Catalogue .....	1
9-5.1	Introduction .....	1
9-6	General portrayal model .....	2
9-6.1	The portrayal process .....	3
9-7	Package overview .....	3
9-8	Data input schema .....	4
9-8.1	Introduction .....	4
9-8.2	Enumerations .....	5
9-8.3	Coordinates .....	6
9-8.4	Associations .....	8
9-8.5	Spatial relations .....	8
9-8.6	Objects .....	10
9-8.7	Spatial objects .....	11
9-8.7.1	Preface .....	11
9-8.7.2	Point .....	12
9-8.7.3	MultiPoint .....	12
9-8.7.4	Curve .....	12
9-8.7.5	CompositeCurve .....	14
9-8.7.6	Surface .....	15
9-9	Information objects .....	15
9-10	Feature objects .....	16
9-11	Portrayal processing .....	16
9-12	Drawing Instructions .....	18
9-12.1	The concepts of drawing instructions .....	18
9-12.1.1	General concept .....	18
9-12.1.2	Portrayal Coordinate Reference Systems .....	18
9-12.1.3	Viewing Groups, Viewing Group Layers and Display Mode .....	19
9-12.1.4	Display Planes .....	19
9-12.1.5	Display Priorities .....	19
9-12.1.6	Null Instruction .....	19
9-12.1.7	Point Instruction .....	19
9-12.1.8	Line Instruction .....	19
9-12.1.9	Area Instruction .....	20
9-12.1.10	Text Instruction .....	20
9-12.1.11	Coverage Instruction .....	20
9-12.1.12	Augmented Geometry .....	21
9-12.2	Model of the Drawing Instruction Package .....	22
9-12.2.1	DisplayList .....	23
9-12.2.2	DrawingInstruction .....	23
9-12.2.3	FeatureReference .....	24
9-12.2.4	SpatialReference .....	24
9-12.2.5	NullInstruction .....	24
9-12.2.6	PointInstruction .....	24
9-12.2.7	LineInstruction .....	24



9-12.2.8	AreaInstruction .....	24
9-12.2.9	TextInstruction .....	25
9-12.2.10	CoverageInstruction .....	25
9-12.2.11	AugmentedGeometry .....	25
9-12.2.12	AugmentedPoint .....	25
9-12.2.13	AugmentedLineOrArea .....	25
9-12.2.14	AugmentedRay .....	25
9-12.2.15	AugmentedPath .....	26
9-12.2.16	AugmentedArea .....	26
9-13	Symbol Definitions .....	26
9-13.1	Overview .....	26
9-13.2	The GraphicBase package .....	27
9-13.2.1	Overview .....	27
9-13.2.2	Model .....	28
9-13.3	The Symbol package .....	32
9-13.3.1	Model .....	32
9-13.4	The LineStyles package .....	33
9-13.4.1	Model .....	34
9-13.5	The AreaFills package .....	36
9-13.5.1	Model .....	37
9-13.6	The Text package .....	39
9-13.6.1	Overview .....	39
9-13.6.2	Fonts .....	39
9-13.6.3	Model .....	40
9-13.7	The Coverage package .....	43
9-13.7.1	Overview .....	43
9-13.7.2	Ranges .....	43
9-13.7.3	Lookup Table .....	43
9-13.7.4	Model .....	44
9-14	The portrayal library .....	46
9-14.1	Overview .....	46
9-14.2	Structure .....	46
9-14.3	Model of the Catalogue .....	46
9-14.3.1	PortrayalCatalog .....	47
9-14.3.2	CatalogItem .....	48
9-14.3.3	ExternalFile .....	48
9-14.3.4	Description .....	48
9-14.3.5	Pixmap .....	48
9-14.3.6	ColorProfiles .....	49
9-14.3.7	Symbols .....	49
9-14.3.8	LineStyle .....	49
9-14.3.9	AreaFills .....	49
9-14.3.10	ViewingGroups .....	49
9-14.3.11	ViewingGroup .....	49
9-14.3.12	FoundationMode .....	49
9-14.3.13	ViewingGroupLayers .....	49
9-14.3.14	ViewingGroupLayer .....	49
9-14.3.15	DisplayModes .....	50
9-14.3.16	DisplayMode .....	50
9-14.3.17	DisplayPlanes .....	50
9-14.3.18	DisplayPlane .....	50
9-14.3.19	Context .....	50
9-14.3.20	ContextParameter .....	50
9-14.3.21	Rules .....	50
9-14.3.22	RuleFile .....	51
9-14.3.23	ParameterType .....	51
9-14.3.24	FileFormat .....	51
9-14.3.25	FileType .....	51
9-14.3.26	RuleType .....	51
9-14.4	Schema for pixmap files .....	51

Appendix 9-A XML Schemas (normative) .....55  
Appendix 9-B XML Schemas (informative) .....95

## 9-1 Scope

This part of the standard defines the models, structures and formats for a machine readable Portrayal Catalogue. The intent is for a Portrayal Catalogue to be delivered separately from product datasets such that it can be imported and interpreted to map Feature objects defined according to the Part 3 General Feature Model (GFM) into Drawing Instructions and symbolization.

The actual contents of a Portrayal Catalogue need to be defined as part of a Product Specification using the mechanism and structures defined in this part. For example a product specification would include an input Schema derived from the abstract schema provided herein, a set of mapping rules (defined in XSLT), a set of symbols, linestyles, colors etc and make it available for use with product datasets.

This part includes mechanisms for portrayal of 2D vector data according to the GFM as well as Coverage data. It does not include drawing instructions and symbol structures intended for 3D portrayal. It does not include the generation of alarms and indications however this might be implemented using a very similar mechanism. It does not include the generation of pick reports or textual reports however the approach of exposing the content to XSLT could be implemented to generate textual or html formatted output.

## 9-2 Conformance

This part of the specification conforms to ISO 19117:2012 (E) according to the Annex A Abstract test suite.

## 9-3 Normative references

The following referenced documents are required for the application of this document. For dated references, only the edition cited applies. For undated references, the latest edition of the referenced document (including amendments) applies.

[ISO 19117: 2012 (E)] Geographic Information - Portrayal

[W3C.REC-XSLT-1.0-19991116] XSL Transformations (XSLT) Version 1.0, W3C Recommendation 16 November 1999, <<http://www.w3.org/TR/xslt>>

[W3C.REC-SVGTiny12-20081222] Scalable Vector Graphics (SVG) Tiny 1.2 Specification, W3C Recommendation 22 December 2008, <<http://www.w3.org/TR/2008/REC-SVGTiny12-20081222>>

[W3C.REC-CSS2-20110607] Cascading Style Sheets Level 2 Revision 1 (CSS 2.1) Specification, W3C Recommendation 07 June 2011, <<http://www.w3.org/TR/2011/REC-CSS2-20110607>>

[TrueType-1.66-1995] True Type Font Revision 1.66 1995, <<http://www.microsoft.com/typography/SpecificationsOverview.aspx>>

## 9-4 Portrayal Catalogue

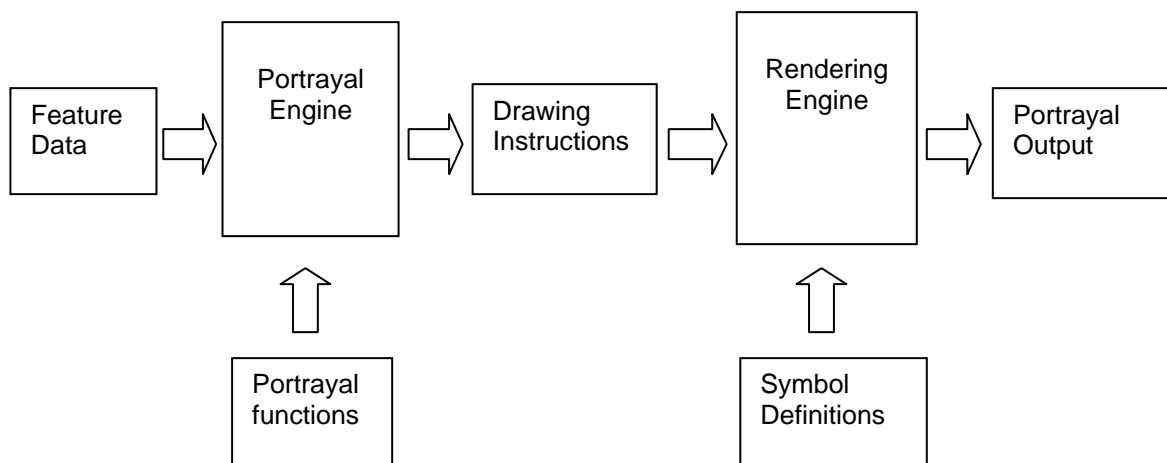
### 9-4.1 Introduction

This part of the standard describes a Portrayal Catalogue and its contents. The concept in this standard is that feature data is modelled with a focus on content and portrayal of a feature is accomplished using rules or functions that map the content to the appropriate symbols and display characteristics. This concept allows the same content to be displayed in different ways and allows the display mapping rules to be maintained without having to modify all the content data.

The Portrayal Catalogue contains portrayal functions that map the features to symbology it also contains symbol definitions, colour definitions, portrayal parameters and portrayal management concepts such as viewing groups. The goal in S-100 is to provide a mechanism where, for a given product, the portrayal catalogue can be delivered as data in a machine readable form such that a compliant implementation can display the product feature data using the given Portrayal Catalogue.

## 9-5 General portrayal model

The general portrayal model is illustrated in figure 9.1.



**Figure 9-1 — General portrayal model**

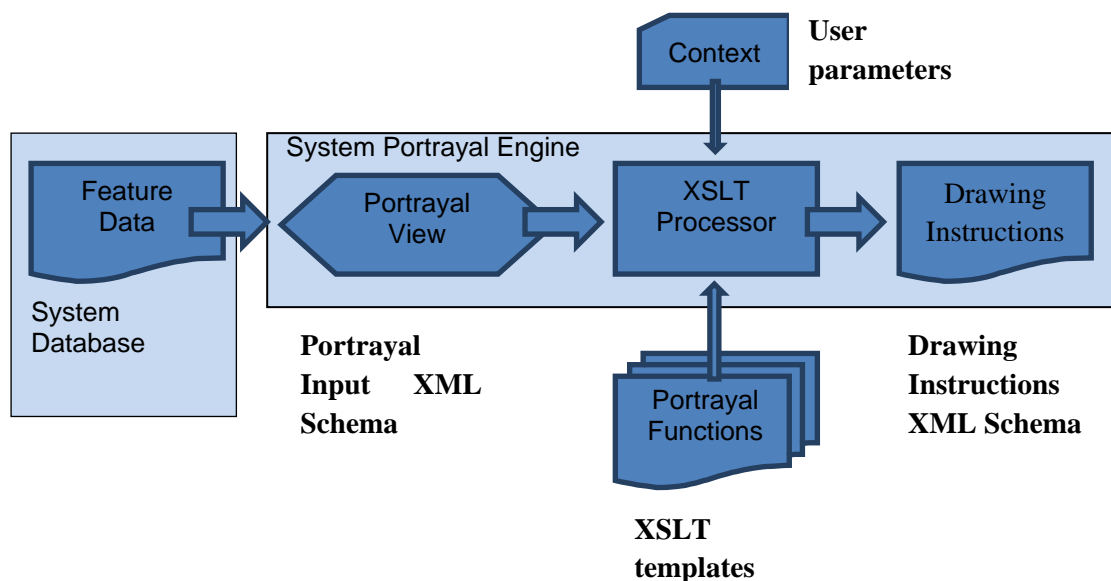
This part of S-100 defines a feature-centred function-based portrayal mechanism. Instances of features are portrayed based on portrayal functions, which make use of geometry and attribute information. The relationship between the feature instances, attributes, and the underlying spatial geometry is specified in a product specification based on the General Feature Model of S-100.

Portrayal information is needed to portray a dataset containing geographic data. The portrayal information is defined as drawing instructions created by specific portrayal functions. The portrayal mechanism makes it possible to portray the same dataset in different ways without altering the dataset itself.

The drawing instructions are intermediate data used by the rendering engine to produce the portrayal output. During the rendering process, the rendering engine uses the symbol definitions to create the output according to the output device.

The symbol definitions contain the details of all graphical elements used for the portrayal. The model of the symbol definitions is described in this document.

## 9-5.1 The portrayal process



**Figure 9-2 — Portrayal process**

The system has Feature data within its internal database that needs to be portrayed. The System Portrayal Engine transforms the Feature data into drawing instructions. Drawing instructions include such things as references to symbol definitions, priority and filtering information. The drawing instructions are further processed by the rendering engine to produce the final display.

In this process, feature data needs to be exposed to the XSLT processor as XML content. The XSLT processor applies the best matching template or portrayal function to each feature. The portrayal function uses the defined logic to transform the input feature content along with related context information into drawing instructions which are output as XML.

The functionality of the System Portrayal Engine is defined in terms of XSLT. XSLT is a declarative language. An XSLT processor transforms XML input into XML output. Contextual and user parameters can be fed into the XSLT processor for use by the portrayal functions. Portrayal functions in XSLT can range from simple lookup or best match templates to complex conditional logic. XSLT is defined to work on an XML node tree however there are implementations that interface the XSLT processor directly with internal structures or relational database tables. Although there are newer versions of XSLT, XSLT 1.0 (<http://www.w3.org/TR/xslt>) has been chosen for this portrayal specification as the most commonly supported.

This portrayal specification defines how machine readable portrayal transformation functions are implemented as XSLT templates disseminated in XSL files. Since XSLT is defined to operate on XML and produce XML the XML input and output schemas are defined as part of this specification. A conformant System Portrayal Engine must operate consistently with XSLT in order to process the machine readable XSL files and produce equivalent output.

## 9-6 Package overview

The following diagram shows the packages for implementing this standard.

The InputSchema describes how the data is presented to the portrayal engine (XSLT processor). The Presentation package includes two subpackages one describing the portrayal catalogue

structure the other describing the drawing instructions. Drawing instructions are the output of the portrayal engine (XSLT processor)

The SymbolDefinitions package describes the graphic primitives used for portrayal.

The portrayal engine is using standard XSLT. There is no package describing this part of the portrayal.

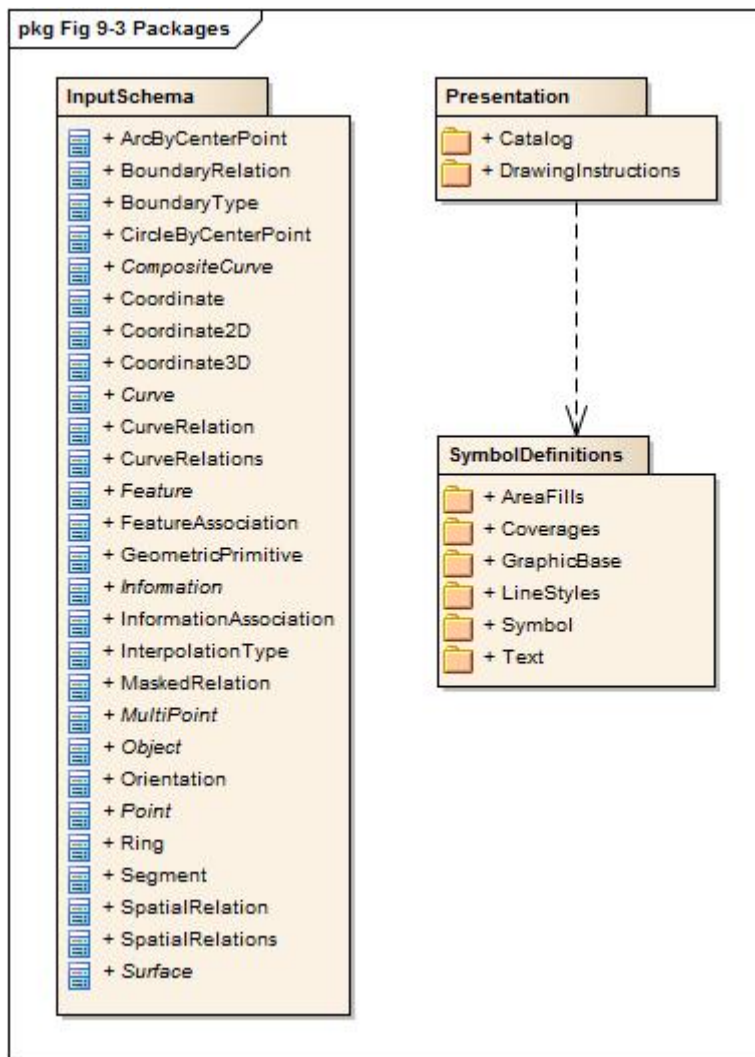


Figure 9-3 — Packages

## 9-7 Data input schema

### 9-7.1 Introduction

The data input schema describes how the data is presented to the XSLT processor. The data can be transformed to an XML document or a presentation of such a document e.g. a DOM-tree. It is also possible to model the data to look like XML and use a special software interface to present such data to the XSLT processor.

Whatever method is used this schema describes how the data must be organized. In this standard only the base types are described. The actual feature types of a data product must be specified in a schema that will be part of the product specification. The data types of such a schema will correspond to the portrayal rules of the same product specification. All feature types in a product must be based on the types specified in this schema.

The schema contains also data types for spatial objects and for associations. Whenever such types are not sufficient for a specific data product, appropriate types can be derived from the types in this standard. This may be the case for spatial objects that needs to have associations to quality information types.

**Note:**

It is assumed for the examples in this section that types of this schema are in the namespace s100.

## 9-7.2 Enumerations

For the use in this schema the following enumeration types are defined:

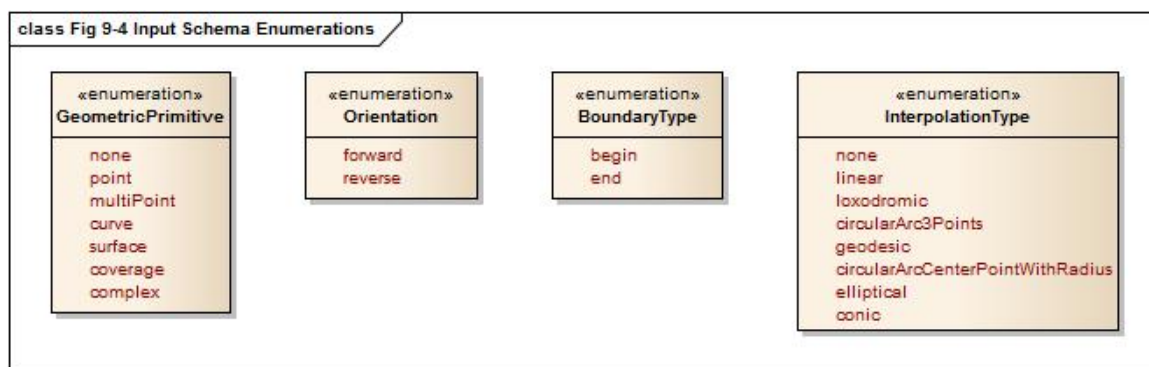


Figure 9-4 — Input Schema Enumerations

### GeometricPrimitive

This enumeration describes the type of geometric primitive that is used by a feature object. If the feature object uses different geometric primitives the value `Complex` has to be used.

```
<xs:simpleType name="GeometricPrimitive">
  <xs:restriction base="xs:string">
    <xs:enumeration value="None"/>
    <xs:enumeration value="Point"/>
    <xs:enumeration value="MultiPoint"/>
    <xs:enumeration value="Curve"/>
    <xs:enumeration value="Surface"/>
    <xs:enumeration value="Coverage"/>
    <xs:enumeration value="Complex"/>
  </xs:restriction>
</xs:simpleType>
```

### Orientation

The enumeration `Orientation` is used to specify the orientation of a referenced geometry that is used by a feature object or by a complex curve.

```
<xs:simpleType name="Orientation">
  <xs:restriction base="xs:string">
    <xs:enumeration value="Forward"/>
    <xs:enumeration value="Reverse"/>
  </xs:restriction>
</xs:simpleType>
```

```
</xs:restriction>  
</xs:simpleType>
```

### BoundaryType

This enumeration describes the type of a topologic boundary.

```
<xs:simpleType name="BoundaryType">  
  <xs:restriction base="xs:string">  
    <xs:enumeration value="Begin"/>  
    <xs:enumeration value="End"/>  
  </xs:restriction>  
</xs:simpleType>
```

### InterpolationType

This enumeration describes the mathematical interpolation method between two control points in a line segment. Note that the methods depend on the underlying coordinate reference system and not all of them are valid for all types of CRS. The product specification should specify the details of the use of interpolation.

```
<xs:simpleType name="InterpolationType">  
  <xs:restriction base="xs:string">  
    <xs:enumeration value="None"/>  
    <xs:enumeration value="Linear"/>  
    <xs:enumeration value="Loxodromic"/>  
    <xs:enumeration value="CircularArc3Points"/>  
    <xs:enumeration value="Geodesic"/>  
    <xs:enumeration value="CircularArcCenterPointWithRadius"/>  
    <xs:enumeration value="Elliptical"/>  
    <xs:enumeration value="Conic"/>  
  </xs:restriction>  
</xs:simpleType>
```

## 9-7.3 Coordinates

In case that coordinates have to be presented to the XSLT processor the following types have to be used.



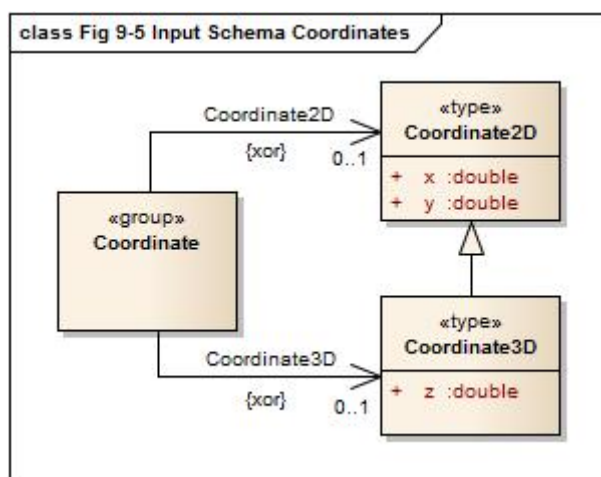


Figure 9-5 — Input Schema Coordinates

The types `Coordinate2D` and `Coordinate3D` are for a simple coordinate tuple. They are defined as:

```
<xs:complexType name="Coordinate2D">
  <xs:sequence>
    <xs:element name="x" type="xs:double"/>
    <xs:element name="y" type="xs:double"/>
  </xs:sequence>
</xs:complexType>

<xs:complexType name="Coordinate3D">
  <xs:complexContent>
    <xs:extension base="Coordinate2D">
      <xs:sequence>
        <xs:element name="z" type="xs:double"/>
      </xs:sequence>
    </xs:extension>
  </xs:complexContent>
</xs:complexType>
```

Note that the type `Coordinate3D` is an extension of the type `Coordinate2D`.

#### Example:

```
<s100:Coordinate2D>
  <s100:x>9.12345</s100:x>
  <s100:y>52.56789</s100:y>
</s100:Coordinate2D>
```

And

```
<s100:Coordinate2D>
  <s100:x>9.12345</s100:x>
  <s100:y>52.56789</s100:y>
  <s100:z>12.5</s100:z>
</s100:Coordinate2D>
```

A group `Coordinate` is defined where coordinate tuple can be used mutually exclusive.

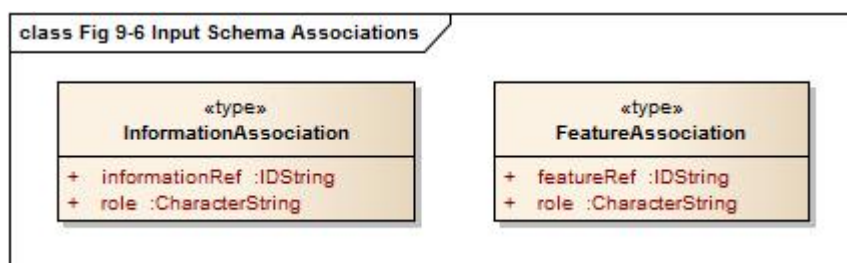
```

<xs:group name="Coordinate">
  <xs:choice>
    <xs:element name="Coordinate2D" type="Coordinate2D"/>
    <xs:element name="Coordinate3D" type="Coordinate3D"/>
  </xs:choice>
</xs:group>

```

## 9-7.4 Associations

According to the general feature model there are two types of associations:



**Figure 9-6 — Input Schema Associations**

For each association a separate type is defined in the schema:

```

<xs:complexType name="InformationAssociation">
  <xs:attribute name="informationRef" type="IDString" use="required"/>
  <xs:attribute name="role" type="xs:string" use="required"/>
</xs:complexType>

<xs:complexType name="FeatureAssociation">
  <xs:attribute name="featureRef" type="IDString" use="required"/>
  <xs:attribute name="role" type="xs:string" use="required"/>
</xs:complexType>

```

The attributes informationRef and featureRef correspond to the attribute id of the referenced information respective feature object. See the section on objects for more details.

If a product specification requires attributes for an association a specific type must be sub-classed in the schema of the product specification.

## 9-7.5 Spatial relations

In the general feature model different relations are modelled between feature types and spatial types but also between spatial types. For such relations the following types are defined by this schema.

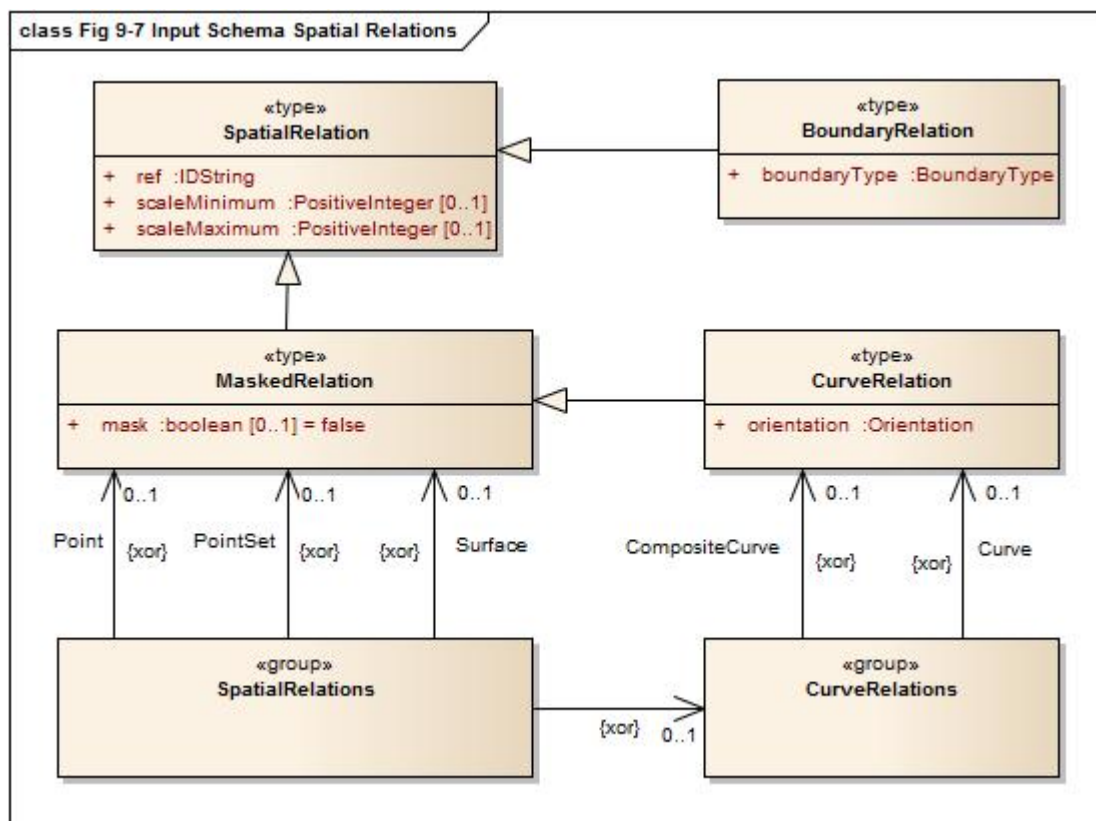


Figure 9-7 — Input Schema Spatial Relations

The type `SpatialRelation` is the base type for all relations to spatial objects. It defines only one attribute `ref` that corresponds to the attribute `id` of the spatial object.

```

<xs:complexType name="SpatialRelation">
  <xs:attribute name="ref" type="IDString" use="required"/>
  <xs:attribute name="scaleMinimum" type="xs:positiveInteger" use="required"/>
  <xs:attribute name="scaleMaximum" type="xs:positiveInteger" use="required"/>
</xs:complexType>
  
```

The other relation types are derived from this type and add information according to the specific use of that relation. The type `MaskedRelation` adds an attribute `mask` that specifies if a referenced spatial object should not be used for portrayal.

```

<xs:complexType name="MaskedRelation">
  <xs:complexContent>
    <xs:extension base="SpatialRelation">
      <xs:attribute name="mask" type="xs:boolean" default="false"/>
    </xs:extension>
  </xs:complexContent>
</xs:complexType>
  
```

Note that the attribute `mask` is not mandatory but has a default value for the case of its absence.

The type `BoundaryRelation` adds a boundary type to the relation and is used when the relation describes a topological relation e.g. the relation to a bounding node of a curve.

```
<xs:complexType name="BoundaryRelation">
  <xs:complexContent>
    <xs:extension base="SpatialRelation">
      <xs:attribute name="boundaryType" type="BoundaryType" use="required"/>
    </xs:extension>
  </xs:complexContent>
</xs:complexType>
```

The type CurveRelation is used whenever a curve is referenced by a spatial relation since it is necessary to specify if the curve is used in the same direction as it is defined or in the reverse order. The type is derived from MaskedRelation since each curve can be a subject of masking.

```
<xs:complexType name="CurveRelation">
  <xs:complexContent>
    <xs:extension base="MaskedRelation">
      <xs:attribute name="orientation" type="Orientation" use="required"/>
    </xs:extension>
  </xs:complexContent>
</xs:complexType>
```

Two groups are defined for Spatial relations. One group defines the possible relations two curves the other defines all possible spatial relations.

```
<xs:group name="CurveRelations">
  <xs:choice>
    <xs:element name="Curve" type="CurveRelation"/>
    <xs:element name="CompositeCurve" type="CurveRelation"/>
  </xs:choice>
</xs:group>

<xs:group name="SpatialRelations">
  <xs:choice>
    <xs:element name="Point" type="MaskedRelation"/>
    <xs:element name="PointSet" type="MaskedRelation"/>
    <xs:element name="Surface" type="MaskedRelation"/>
    <xs:group ref="CurveRelations"/>
  </xs:choice>
</xs:group>
```

How these groups are used is demonstrated in Annex B – How to write a schema for a specific data product.

### 9-8.3. Objects

All objects in a data set are based on the type Object which carries the common properties of all objects. The only commonality on objects is the identifier. Each objects needs to be identifiable within a data set. This is done by the attribute id.

In the product specific schemas constraints can be made on this identifiers, in particular by the use of the <xs:key> and <xs:keyref> elements.

```
<xs:complexType name="Object" abstract="true">
  <xs:attribute name="id" type="IDString" use="required"/>
```

</xs:complexType>

Note that the type of the identifier is **IDString** to be as general as possible with respect to different methods used for identification. The characters allowed in this string are 0-9a-zA-Z.

```
<xs:simpleType name="IDString">
  <xs:restriction base="xs:string">
    <xs:minLength value="1"/>
    <xs:pattern value="[0-9a-zA-Z_]*"/>
  </xs:restriction>
</xs:simpleType>
```

The model of all objects is given in following diagram.

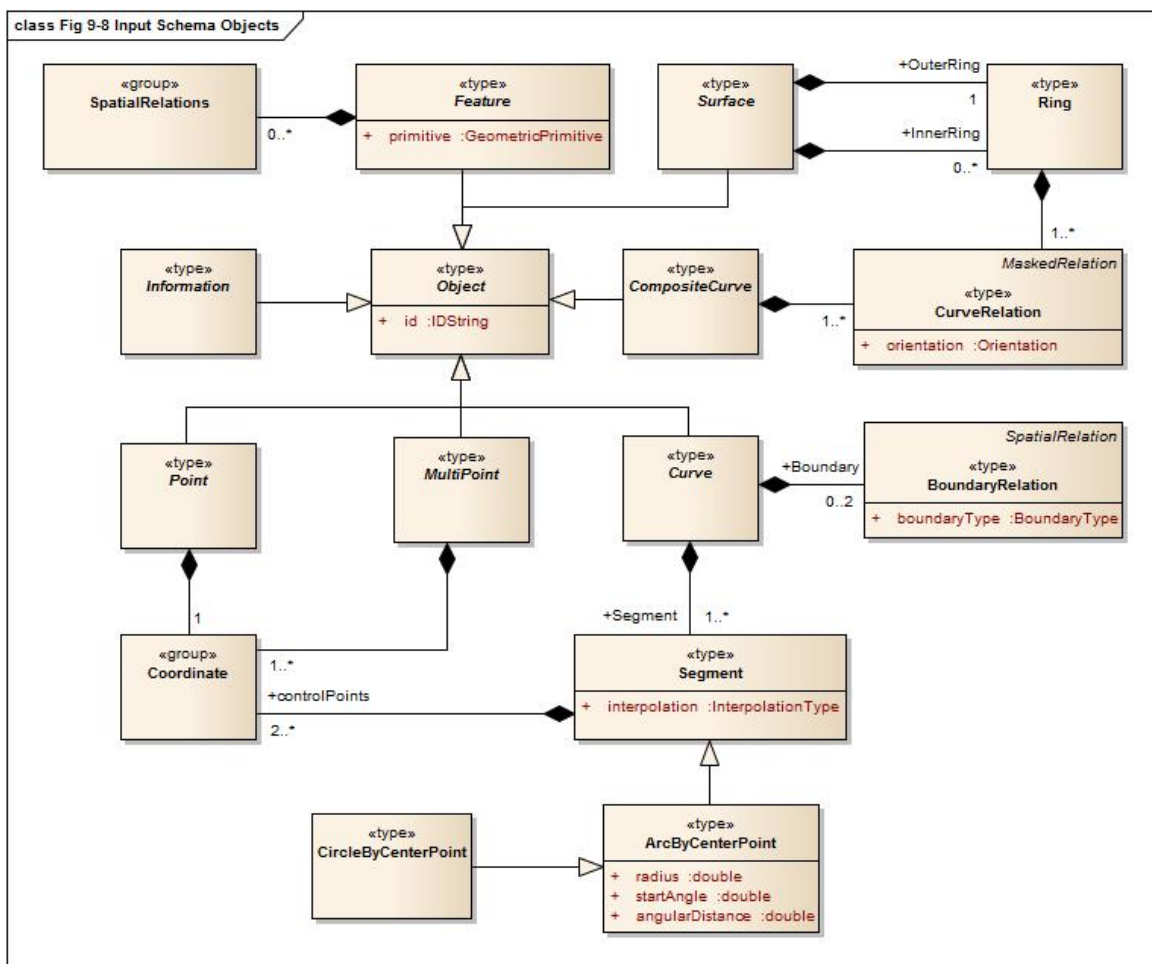


Figure 9-8 — Input Schema Objects

### 9-7.6 Spatial objects

#### 9-7.6.1 Preface

Spatial objects in a data set carry the geometric location of a feature object. The following types are supported by this standard:

- Point
- MultiPoint

- Curve
- Composite curve
- Surface

All types described here are abstract and have to be sub-classed in the product schema. Additional properties can then be added in the derived types. Such properties may be association to quality information types or other associations. Attributes are not permitted for spatial objects by the GFM. All types are derived from the type Object i.e. they have an identifier.

### 9-7.6.2 Point

A point carries a single coordinate tuple, 2D or 3D. The definition looks like.

```
<xs:complexType name="Point" abstract="true">
  <xs:complexContent>
    <xs:extension base="Object">
      <xs:sequence>
        <xs:group ref="Coordinate"/>
      </xs:sequence>
    </xs:extension>
  </xs:complexContent>
</xs:complexType>
```

Note that the group Coordinate is used within the definition to allow both Coordinate2D and Coordinate3D elements

### 9-7.6.3 MultiPoint

Similar to Point this type defines point geometry for a feature object. The difference is that a set of tuples can be defined. Therefore maxOccurs is set to unbounded.

```
<xs:complexType name="MultiPoint" abstract="true">
  <xs:complexContent>
    <xs:extension base="Object">
      <xs:sequence>
        <xs:group ref="Coordinate" minOccurs="1" maxOccurs="unbounded"/>
      </xs:sequence>
    </xs:extension>
  </xs:complexContent>
</xs:complexType>
```

### 9-7.6.4 Curve

Curves describe the line geometry of a feature object. They are made of segments where each segment has a sequence of control points and an interpolation method. The latter defines the geometry between the control points according to the used coordinate reference system. There are two special types of segments:

1. ArcByCenterPoint  
A circular arc defined by a center point and a radius. The beginning of the arc is defined by the start angle and the length of the arc is defined by the angular length. This length is a signed quantity defining the direction of the arc: positive means clockwise.
2. CircleByCenterPoint  
A circle defined by a center point and a radius.

The abstract type SegmentBase defines a sequence of control points and the attribute for the interpolation type:

```
<xs:complexType name="SegmentBase" abstract="true">
  <xs:sequence>
    <xs:element name="ControlPoint" type="Coordinate2D" minOccurs="1" maxOccurs="unbounded"/>
  </xs:sequence>
  <xs:attribute name="interpolation" type="InterpolationType" use="required"/>
</xs:complexType>
```

From this type the type Segment is derived by restrict the number of control points two at least 2:

```
<xs:complexType name="Segment">
  <xs:complexContent>
    <xs:restriction base="SegmentBase">
      <xs:sequence>
        <xs:element name="ControlPoint" type="Coordinate2D" minOccurs="2" maxOccurs="unbounded"/>
      </xs:sequence>
    </xs:restriction>
  </xs:complexContent>
</xs:complexType>
```

For the “by center point” segments the abstract base type is also derived from SegmentBase restricting the number of control points to exact 1 and fixes the value of the attribute interpolation.

```
<xs:complexType name="ArcByCenterPointBase" abstract="true">
  <xs:complexContent>
    <xs:restriction base="SegmentBase">
      <xs:sequence>
        <xs:element name="ControlPoint" type="Coordinate2D" minOccurs="1" maxOccurs="1"/>
      </xs:sequence>
      <xs:attribute name="interpolation" type="InterpolationType" use="required"
        fixed="CircularArcCenterPointWithRadius"/>
    </xs:restriction>
  </xs:complexContent>
</xs:complexType>
```

The ArcByCenterPoint is then an extension of this type adding attributes for radius, start angle and angular length.

```
<xs:complexType name="ArcByCenterPoint">
  <xs:complexContent>
    <xs:extension base="ArcByCenterPointBase">
      <xs:attribute name="radius" type="xs:double" use="required"/>
      <xs:attribute name="startAngle" type="xs:double" use="required"/>
      <xs:attribute name="angularDistance" type="xs:double" use="required"/>
    </xs:extension>
  </xs:complexContent>
</xs:complexType>
```

The CircleByCenterPoint type is very similar. The attribute start angle is not defined since it is meaningless. The direction is here defined by the attribute direction which has values '+' or '-'.

```
<xs:simpleType name="Direction">
  <xs:restriction base="xs:string">
    <xs:enumeration value="+"/>
    <xs:enumeration value="-"/>
  </xs:restriction>
</xs:simpleType>

<xs:complexType name="CircleByCenterPoint">
  <xs:complexContent>
    <xs:extension base="ArcByCenterPointBase">
      <xs:attribute name="radius" type="xs:double" use="required"/>
      <xs:attribute name="direction" type="Direction" default="+"/>
    </xs:extension>
  </xs:complexContent>
</xs:complexType>
```

A group is defined that allows the use of the different type of segments.

```
<xs:group name="Segments">
  <xs:choice>
    <xs:element name="Segment" type="Segment"/>
    <xs:element name="ArcByCenterPoint" type="ArcByCenterPoint"/>
    <xs:element name="CircleByCenterPoint" type="CircleByCenterPoint"/>
  </xs:choice>
</xs:group>
```

The type Curve finally combines a sequence of segments with the topological boundary. The topological boundary of a curve is the beginning and end node implemented by a Point object.

```
<xs:complexType name="Curve" abstract="true">
  <xs:complexContent>
    <xs:extension base="Object">
      <xs:sequence>
        <xs:element name="Boundary" type="BoundaryRelation" minOccurs="0" maxOccurs="2"/>
        <xs:group ref="Segments" minOccurs="1" maxOccurs="unbounded"/>
      </xs:sequence>
    </xs:extension>
  </xs:complexContent>
</xs:complexType>
```

### 9-7.6.5 CompositeCurve

A composite curve describes the line geometry of a feature object just like a 'simple' curve. But instead using coordinates to define the geometry it is using a sequence of other curves, including other composite curves. With other words it is a sequence of relations to other curves.

```
<xs:complexType name="CompositeCurve" abstract="true">
  <xs:complexContent>
    <xs:extension base="Object">
      <xs:sequence>
```



```

    <xs:group ref="CurveRelations" minOccurs="1" maxOccurs="unbounded"/>
  </xs:sequence>
</xs:extension>
</xs:complexContent>
</xs:complexType>

```

### 9-7.6.6 Surface

Surfaces describe the area geometry of a feature object. The surface itself is defined by its boundary. The boundary consists of an outer ring and optionally a number of inner rings. The inner rings describe holes in the area. Each ring is a closed polygon made from one or many curves. That means that a ring is very similar to a composite curve but unlike the composite curve it is not derived from `Object` because it does not need to be identifiable. The definition of a ring simply looks like:

```

<xs:complexType name="Ring">
  <xs:group ref="CurveRelations" minOccurs="1" maxOccurs="unbounded"/>
</xs:complexType>

```

And the definition of a surface finally is:

```

<xs:complexType name="Surface" abstract="true">
  <xs:complexContent>
    <xs:extension base="Object">
      <xs:sequence>
        <xs:element name="OuterRing" type="Ring"/>
        <xs:element name="InnerRing" type="Ring" minOccurs="0" maxOccurs="unbounded"/>
      </xs:sequence>
    </xs:extension>
  </xs:complexContent>
</xs:complexType>

```

## 9-8 Information objects

Information objects are identifiable and sharable pieces of information within a data set. In the model an abstract type `Information` is derived from the type `Object`. Although no additional properties are added, this type is useful for semantic reasons. Information types in a product specification can be derived from the type `Information` to indicate that they are information types.

```

<xs:complexType name="Information" abstract="true">
  <xs:complexContent>
    <xs:extension base="Object"/>
  </xs:complexContent>
</xs:complexType>

```

Note that the type is abstract. Any realization of an information type in a data product has to be derived from this type.

## 9-9 Feature objects

Feature objects are abstractions of real world phenomena. This schema defines the abstract base type for any feature type. The type Feature is derived from Object and adds a sequence of spatial relations and a geometric primitive attribute to the properties from the base class. All feature types in a product specification will be derived from this type. They can carry additional elements for feature attributes, feature associations or information associations.

```
<xs:complexType name="Feature" abstract="true">
  <xs:complexContent>
    <xs:extension base="Object">
      <xs:sequence>
        <xs:group ref="SpatialRelations" minOccurs="0" maxOccurs="unbounded"/>
      </xs:sequence>
      <xs:attribute name="primitive" type="GeometricPrimitive" use="required"/>
    </xs:extension>
  </xs:complexContent>
</xs:complexType>
```

All feature types in a product has to be derived from this abstract type. How to do this is described in an annex of this standard.

For schema definition see A.1 Input Schema

## 9-10 Portrayal processing

This specification is referencing XSLT 1.0 which is a W3C recommendation, <http://www.w3.org/TR/xslt>

XSLT uses XPath 1.0 to address components of a document. <http://www.w3.org/TR/xpath/>

XSLT (XSL Transformations) is a language expressed as a well formed XML document. The intended purpose of using XSLT in portrayal is to transform the data into drawing instructions. Since XSLT is expressed in XML it is useful for interchange as a machine readable transformation language. XSLT is widely used across many domains but is perhaps most commonly used to transform XML documents into HTML for web page displays. There are many tutorials, books and reference material available for XSLT. There are also several web sites where questions can be posted and examples can be found.

XSLT uses templates to process nodes in the input XML tree and generate nodes as output XML, other SGML formats or even plain text. There are two types of templates a matching template and a named template.

Matching templates use a matching expression using XPATH to specify what elements in the input document should be processed by that template. XPATH (XML Path Language) is an expression language used to address or find components in an XML document. The path capability makes it especially useful when dealing with a hierarchy of content such as nested complex attributes. Only one matching template can match an element from the input document. Matching templates have a built in priority calculation and conflict resolution method that is used to determine which one to use in the case where multiple templates match the same element. Priority numbers can be explicitly assigned as an attribute of a matching template in order to override the default conflict resolution behaviour.

Named templates are called by another template along with the data to be processed. Named templates can also have parameters. These are useful for formatting or other operations that are commonly used in a transformation. A named template can even call itself (recursion), which can be useful for operations such as string token parsing.

A template can loop over a set of nodes that match an XPath expression using an “xsl:apply-templates” or “xsl:for-each” instruction element. The nodes can also be sorted before being processed. Conditional processing is available by using a simple “xsl:if” instruction or an “xsl:choose” instruction. The choose instruction allows a set of expressions to be tested such that only the first one matching is processed and if no match is found an optional otherwise statement is used to handle a default. This is useful for testing enumerated data such that a different output is generated depending upon the enumeration value.

XSLT also includes the ability to have parameters passed at the top level and accessed within any of the templates. These parameters can be useful to provide contextual information to the transformation. There are also variables in XSLT but they can only be assigned data as part of their definition, unlike other languages where variables can be reassigned. Variables are useful to collect data or decision results that can be passed as parameters to another template or used in conditional statements.

XSLT can include or import other XSLT documents. This capability can be useful for management of templates and reuse of templates by multiple top level XSLT documents.

## Examples

Given the example XML below

```
<BeaconCardinal id="2">
  <s100:Point ref="3"/>
  <categoryOfCardinalMark>3</categoryOfCardinalMark>
</BeaconCardinal>
<BeaconCardinal id="3">
  <s100:Point ref="3"/>
  <categoryOfCardinalMark>2</categoryOfCardinalMark>
</BeaconCardinal>
```

A simple matching XSLT template used as a portrayal function

```
<xsl:template match="BeaconCardinal">
  <!--This is a comment. This template matches a BeaconCardinal node and the body of the
  template can examine data and output results -->
</xsl:template>
```

The above template will be used to process all of the BeaconCardinal objects.

The choose instruction can be used to do conditional processing within the template.

```
<xsl:template match="BeaconCardinal">
  <xsl:choose>
    <xsl:when test="categoryOfCardinalMark = '2'">
      <!-- Output symbol for BeaconCardinal categoryOfCardinalMark =2 here -->
    </xsl:when>
    <xsl:when test="categoryOfCardinalMark = '3'">
      <!-- Output symbol for BeaconCardinal categoryOfCardinalMark =3 here -->
    </xsl:when>
    <xsl:otherwise>
      <!-- Output default symbol here -->
    </xsl:otherwise>
  </xsl:choose>
</xsl:template>
```

A more advanced XPath expression can be used to refine the match.

```
<xsl:template match="BeaconCardinal[categoryOfCardinalMark=2] ">
  <!--This is a comment. Output symbol for BeaconCardinal categoryOfCardinalMark =2 here -->
</xsl:template>
```

## 9-11 Drawing Instructions

### 9-11.1 The concepts of drawing instructions

#### i. General concept

The output of the portrayal engine is a set of drawing instructions, which link the feature type to a symbol reference. The geometry is either taken from the feature type or can be generated by the portrayal functions. The latter is supported by the concept of augmented geometry.

#### ii. Portrayal Coordinate Reference Systems (CRS)

In this context coordinate reference systems refer to the portrayal geometry only.

There are different CRS related to the portrayal:

- Geographic CRS
- Portrayal CRS
- Local CRS
- Line CRS
- Area CRS
- Tile CRS
- Hatch CRS

Geographic CRS are used in the geographic dataset that are portrayed. They will be mapped by means of projections and affine transformation to the Portrayal CRS. Nevertheless rotations of symbols may be still defined relative to the North-Axis of the Geographic CRS.

The Portrayal CRS defines the coordinates at the output device e.g. a screen or pixmap.

Line symbols have two kinds of coordinate reference systems. The line coordinate reference system is a non-Cartesian 2-axis coordinate system. The x-axis is following the line geometry and the y-axis is perpendicular to the geometry of the curve. This CRS allows for the specification of line widths, offsets and symbols following the geometry. The second kind of coordinate reference system is a local Cartesian coordinate reference system which is defined for every location along a curve. This coordinate reference system has an x-axis that is tangential to the curve and a y-axis perpendicular to the x-axis.

An area symbol defines coordinate reference systems for its boundary and for its interior. The boundary coordinate reference systems are those defined for line symbols. The interior of the area symbol has its own coordinate reference system.

For tiled pattern and hatch patterns own CRS are defined.

### iii. Viewing Groups, Viewing Group Layers and Display Mode

The viewing group is a concept to control the content of the display. It works as an on/off switch for any drawing instruction assigned to the corresponding viewing group. The concept can be seen as a filter on the list of drawing instructions.

Viewing groups can be aggregated into Viewing Group Layers and Viewing Group Layer can be aggregated into Display Modes. Both aggregations are part of the portrayal catalogue.

### iv. Display Planes

Display planes are a concept to split the output of the portrayal functions into separate lists. An example of this is the separation of chart information drawn under a radar image and chart information drawn over a radar image.

### v. Display Priorities

Display priorities control the order in which the output of the portrayal functions is processed by the rendering engine. Priorities with smaller numerical values will be processed first.

### vi. Null Instruction

This is an instruction to indicate that a feature is intentionally not portrayed.

### vii. Point Instruction

#### Overview

The Point Instruction defines the drawing of a symbol. The symbol can be parameterized. This includes rotation, scaling and offset. The details are described in the documentation of the Symbol package.

#### Point Geometry

When the Point Instruction references point geometry the symbol is drawn using its position.

#### MultiPoint Geometry

The symbol is repeated using each position of the Multi Point.

#### Curve Geometry

The symbol is drawn on each referenced curved from either the spatialReference or if this is not used on each curve directly referenced by the feature type. The placement of the symbol is controlled by the linePlacement element of the symbol. The details are described in the documentation of the Symbol package.

#### Surface Geometry

The symbol is drawn at a representative position within the surface. How this position is obtained is controlled by the areaPlacement member of the symbol. The details are described in the documentation of the Symbol package.

### viii. Line Instruction

#### Overview

The Line Instruction defines the drawing of a line style. Line styles include Simple and Complex Line Styles. The line style can be parameterized. The details are described in the documentation of the LineStyles package. The geometry is defined by the referenced spatial types. Only curve or surface geometry is supported. For the latter the boundary of the surface defines the geometry. The geometry defines the direction of drawing for the line style.

## Suppression

When features shares curve geometry multiple line instructions may reference the same curve.

If suppression is set to true (the default) another line instruction with a higher display priority will suppress the drawing of this line instruction. If suppression is set to false this instruction cannot be suppressed.

## ix. Area Instruction

### Overview

The Area Instruction defines the drawing of an area fill. Area Fills include Color Fills and different Pattern Fills. The area fill can be parameterized. The details are described in the documentation of the AreaFills package. Only surface geometry is supported.

## x. Text Instruction

### Overview

The Text Instruction defines the drawing of text. The text can be parameterized. This includes fonts, colour and size. The details are described in the documentation of the Text package.

### Point Geometry

When the Text Instruction references a point geometry the text is drawn using its position. Only TextPoint elements are supported.

### MultiPoint Geometry

The text is repeated using each position of the Multi Point. Only TextPoint elements are supported.

### Curve Geometry

The text is drawn on each referenced curved from either the spatialReference or if this is not used on each curve directly referenced by the feature type. Both TextPoint and TextLine elements are supported. The first is to draw text at a position on the referenced curve relative to the local CRS at that position. The latter is to draw text that follows the shape of the referenced curve. More details can be found in the documentation of the text package.

### Surface Geometry

The text is drawn at a representative position within the surface. Only TextPoint elements are supported. How this position is obtained is controlled by the areaPlacement member of the TextPoint. The details are described in the documentation of the Text package.

## xi. Coverage Instruction

An instruction to portray data coverages like gridded bathymetry, satellite images, etc.

*“A coverage is a feature that has multiple values for each attribute type, where each direct position within the geometric representation of the feature has a single value for each attribute type.” [ISO 19123:2005, Introduction]*

In this document coverage attributes used for portrayal are expected to have numeric values.

The assignment of Portrayal for a Coverage starts with a Coverage Feature. Like other Feature types a rule (XSLT template) is used to match the Feature to Drawing instructions.

A first match lookup table is used to assign portrayal based on a specified coverage attribute. There are three options for coverage portrayal, filling with colour, annotating with numeric text or annotating with symbols.

## Colour assignment

Colours are applied to a coverage by using a lookup table that matches a selected attribute value and specifies a colour. For a continuous coverage such as grid cells, pixels or tiles then each element is processed and colour filled with the appropriate colour. For a discrete coverage with distinct points colour is applied as a Pen Down or dott operation using the assigned pen width.

A lookup table entry can match a range of values and assign a single colour to that range or specify a start and end colour that is used to create a gradient or ramp effect as a linear interpolation of the value range across the colour range.

## Numeric and Symbol Annotations

For a continuous coverage the centre of each cell (e.g. rectangle, tile, triangle) is used as the anchor point of the text or symbol.

For numeric annotations, overplot removal or collision avoidance is expected. A buffer can be used to provide some space between the annotations. A buffer of 0 means that direct overplot is used when digits interact. An enumeration called 'champion' is used to specify which annotation to keep (largest or smallest value) when an interaction occurs. For numeric annotations the text shall be placed such that the optical/geometric centre of the text represents the location.

For symbol annotations separate attributes from the coverage can be used to apply a scaling and rotation to the symbol. This can be useful for example when portraying a coverage that carries wave height and direction.

## xii. Augmented Geometry

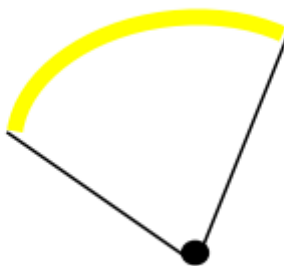
### Overview

In case the required geometry for a drawing instruction is not explicitly given in a geographic dataset the portrayal function will generate this "augmented" geometry. A set of classes for such augmented geometries are part of the model. All positions used in this classes refer to a given coordinate reference system. Three types of CRS are supported:

1. Geographic CRS  
The coordinates are geographic coordinates.
2. Portrayal CRS  
The coordinate are referenced to the output device of the portrayal.
3. Local CRS  
The coordinates referring to a coordinate system with axes parallel to the Portrayal CRS but the origin shifted to the position of the referenced feature. Only point feature are supported for that type of CRS.

Note: The generated geometry only exists temporary for the purpose of portrayal and is not part of the dataset.

All types of augmented geometries can be used for the portrayal of text.



**Figure 9-9 — Point Feature with Augmented geometries**

More details can be found in the documentation of the drawing instruction model.

### **9-11.2 Model of the Drawing Instruction Package**

This package contains classes which describe the output of the portrayal functions. Display instructions link the feature types and their geometry to elements from the Symbol Elements package. The next diagram shows the model.



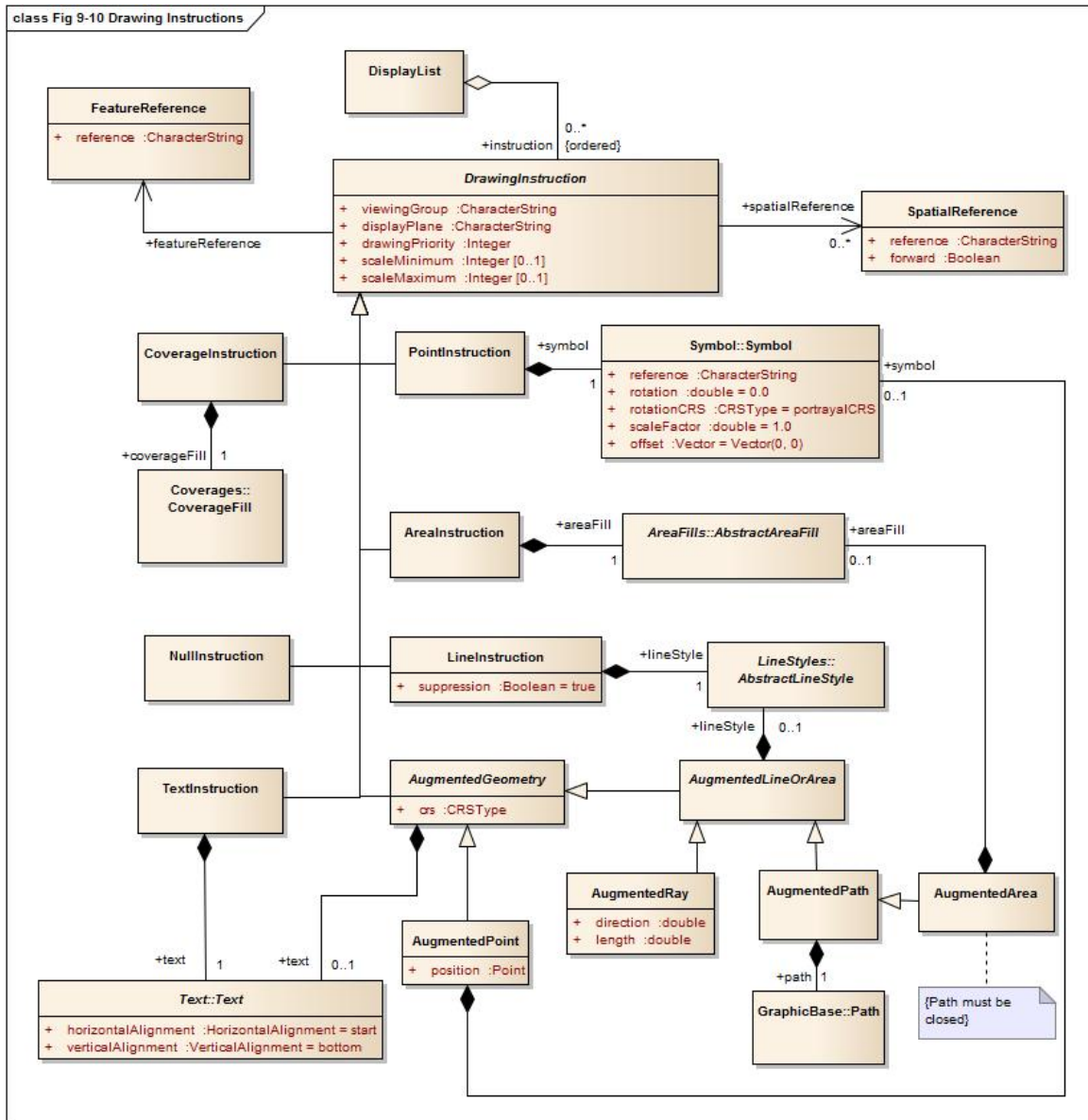


Figure 9-10 — Drawing Instructions

9-11.2.1 DisplayList

Role Name	Name	Description	Mult.	Type
Class	DisplayList	A ordered set of Drawing Instructions	-	-
Role	instruction	An instruction of this list	0..*	DrawingInstruction

9-11.2.2 DrawingInstruction

Role Name	Name	Description	Mult.	Type
Class	DrawingInstruction	Abstract base class for all drawing instructions.	-	-
Attribute	viewingGroup	The viewing group the instruction is assigned to.	1	string
Attribute	displayPlane	The display plane the instruction is assigned to	1	string
Attribute	drawingPriority	The priority that defines the order of drawing.	1	integer

Attribute	scaleMinimum	Scale denominator to define the minimum scale for which the instruction will be shown. If not given there is no minimum scale.	0..1	integer
Attribute	scaleMaximum	Scale denominator to define the maximum scale for which the instruction will be shown. If not given there is no maximum scale.	0..1	integer
Role	featureReference	The reference to the feature type that will be depicted by the instruction.	1	FeatureReference
Role	spatialReference	The reference(s) to the spatial type components of the feature that defines the geometry used for the depiction. Not used when the entire geometry of the feature should be depicted.	0..*	SpatialReference

### 9-11.2.3 FeatureReference

Role Name	Name	Description	Mult.	Type
Class	FeatureReference	A reference to a feature type	-	-
Attribute	reference	The identifier of the feature type	1	string

### 9-11.2.4 SpatialReference

Role Name	Name	Description	Mult.	Type
Class	SpatialReference	A reference to a spatial type.	-	-
Attribute	reference	The identifier of the spatial type.	1	string
Attribute	forward	If true the spatial object is used in the direction in which it is stored in the data. Only applies to curves.	1	boolean

### 9-11.2.5 NullInstruction

Role Name	Name	Description	Mult.	Type
Class	NullInstruction	An instruction that indicates that no portrayal is required for the referenced feature.	-	-

### 9-11.2.6 PointInstruction

Role Name	Name	Description	Mult.	Type
Class	PointInstruction	A drawing instruction for point symbol.	-	-
Role	symbol	The symbol to be depicted.	1	Symbol::Symbol

### 9-11.2.7 LineInstruction

Role Name	Name	Description	Mult.	Type
Class	LineInstruction	A drawing instruction for line geometry.	-	-
Role	lineStyle	The line style used for the depiction.	1	LineStyles::AbstractLineStyle

### 9-11.2.8 AreaInstruction

Role Name	Name	Description	Mult.	Type
Class	AreaInstruction	A drawing instruction for area geometry.	-	-
Role	areaFill	The area fill used for the depiction.	1	AreaFills::AbstractAreaFill

**9-11.2.9 TextInstruction**

Role Name	Name	Description	Mult.	Type
Class	TextInstruction	A drawing instruction for depicting text.	-	-
Role	text	The text to be depicted.	1	Text::Text

**9-11.2.10 CoverageInstruction**

Role Name	Name	Description	Mult.	Type
Class	CoverageInstruction	A drawing instruction for depicting coverages of data.	-	-
Role	coverageFill	The coverage fill used for depiction.	1	Coverages::CoverageFill

**9-11.2.11 AugmentedGeometry**

Role Name	Name	Description	Mult.	Type
Class	AugmentedGeometry	A base class for drawing instructions that uses geometry not available in the dataset. The geometry is generated by the portrayal functions according to a defined CRS.	-	-
Attribute	crs	The coordinate reference system of the generated geometry. One of <ul style="list-style-type: none"> <li>Geographic CRS</li> <li>Portrayal CRS</li> <li>Local CRS</li> </ul> For detailed description see the documentation of the GraphicsBase package.	1	GraphicBase::CRSType
Role	text	A text to be depicted by the instruction. The rules for text apply depending on the type of geometry used by the instruction.	0..1	Text::Text

**9-11.2.12 AugmentedPoint**

Role Name	Name	Description	Mult.	Type
Class	AugmentedPoint	A drawing instruction for a point symbol where the position is not given by the feature type.	-	-
Attribute	position	The position of the symbol.	1	GraphicBase::Point
Role	symbol	The symbol to be depicted.	0..1	Symbol::Symbol

**9-11.2.13 AugmentedLineOrArea**

Role Name	Name	Description	Mult.	Type
Class	AugmentedLineOrArea	A base class for linear augmented geometry.	-	-
Role	lineStyle	The line style to be depicted.	0..1	LineStyle::LineStyle

**9-11.2.14 AugmentedRay**

Role Name	Name	Description	Mult.	Type
Class	AugmentedRay	A drawing instruction that defines a line from the position of a point feature to another position. The position is defined by the direction and the length attributes. It can be used for drawing line styles or line texts.	-	-

Attribute	direction	The direction of the ray relative to the used CRS.	1	double
Attribute	length	The length of the ray. The units depending on the used CRS.	1	double

### 9-11.2.15 AugmentedPath

Role Name	Name	Description	Mult.	Type
Class	AugmentedPath	A drawing instruction for a line. It can be used for drawing line styles or line texts.	-	-
Role	path	The path defining the line geometry.	1	GraphicsBase::Path

### 9-11.2.16 AugmentedArea

Role Name	Name	Description	Mult.	Type
Class	AugmentedArea	A drawing instruction for an area. It can be used for drawing line styles, area fills, or area texts. The used path must be closed.	-	-
Role	areaFill	The area fill to be depicted.	0..1	AreaFills::AreaFill

For schema definition see A.3 Presentation Schema

## 9-12 Symbol Definitions

### 9-12.1 Overview

The SymbolDefinition package describes the graphic primitives used for the portrayal. Parts of the primitives are defined externally by using SVG definitions. Those external parts will be referenced from the types in this model. The package diagram is shown in the following figure.

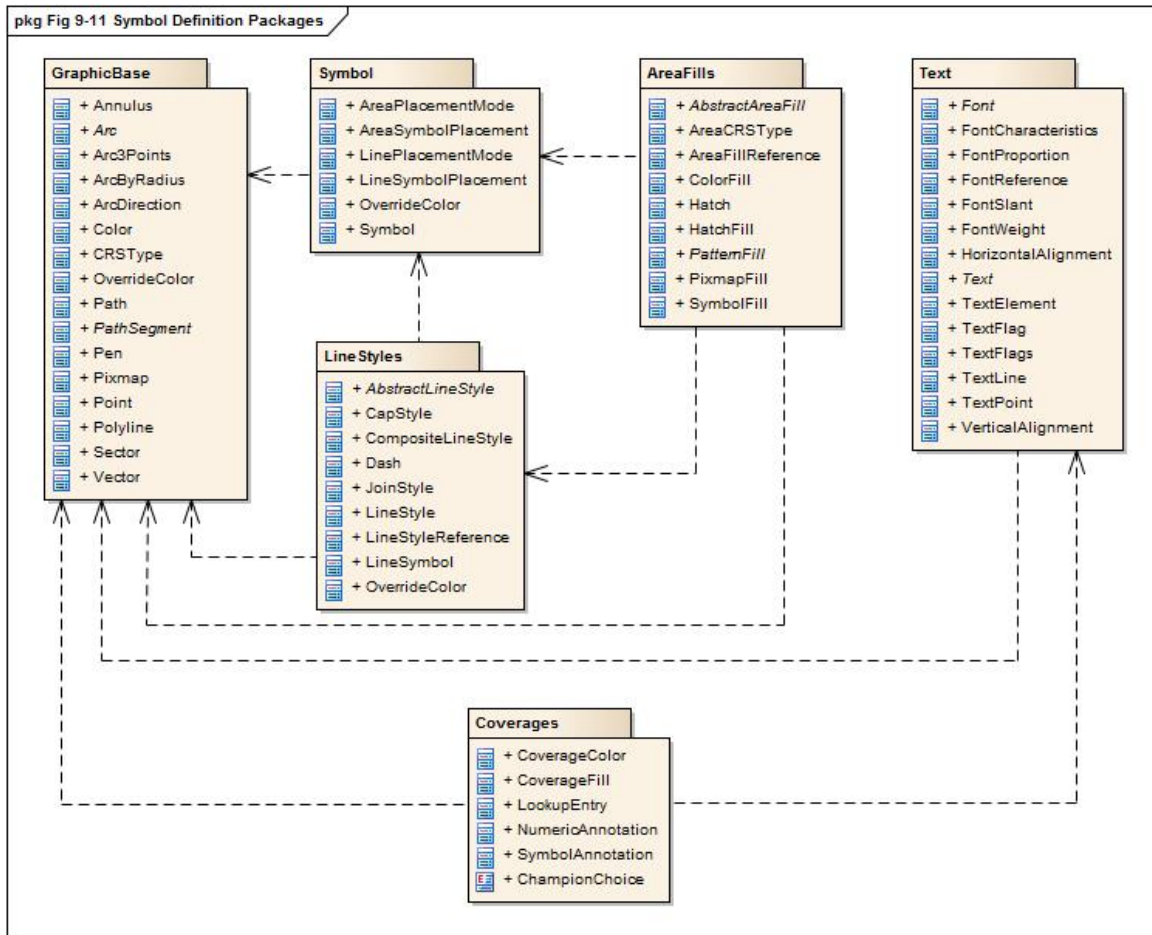


Figure 9-11 — Symbol Definition Packages

## 9-12.2 The GraphicBase package

### 9-12.2.1 Overview

This package contains graphic base types for the use in other packages.

### 9-12.2.2 Model

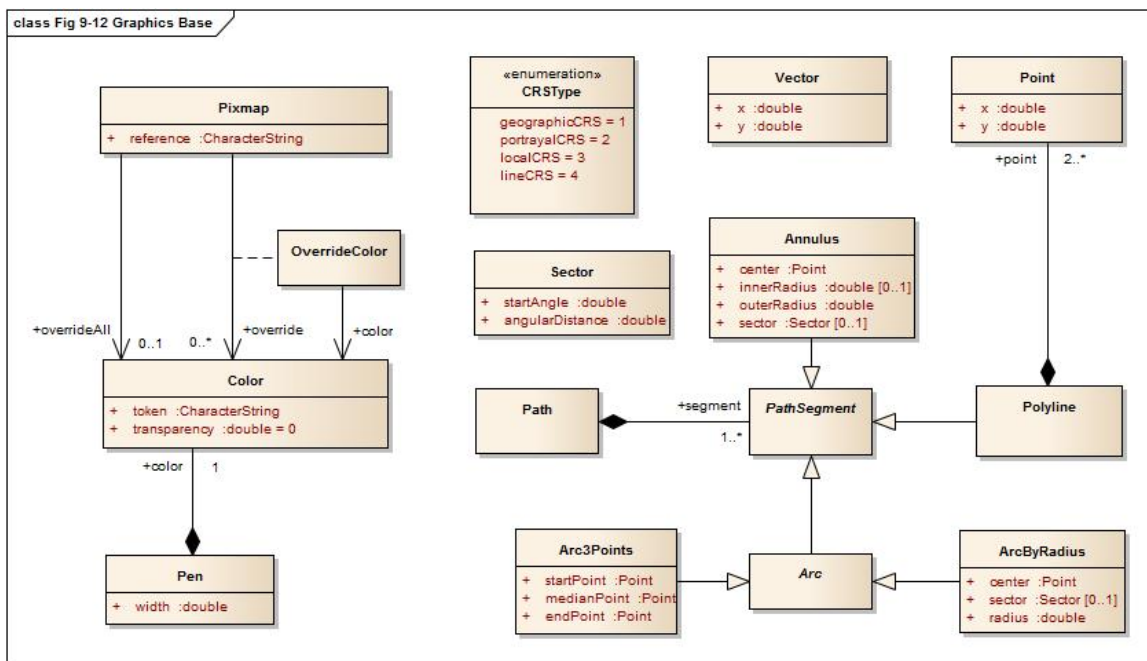


Figure 9-12 — Graphics Base

#### 9-12.2.2.1 Point

Role Name	Name	Description	Mult.	Type
Class	Point	A zero-dimensional geometric object in a two-dimensional coordinate space. The coordinate will refer to a coordinate reference system.	-	-
Attribute	x	The x-coordinate of the point. In case the CRS is a geographic CRS this refers to the longitude.	1	double
Attribute	y	The y-coordinate of the point. In case the CRS is a geographic CRS this refers to the latitude.	1	double

#### 9-12.2.2.2 Vector

Role Name	Name	Description	Mult.	Type
Class	Vector	A geometric object that has both a magnitude and a direction. It is limited to Cartesian coordinate reference systems.	-	-
Attribute	x	The x-coordinate of the vector.	1	double
Attribute	y	The y-coordinate of the vector.	1	double

#### 9-12.2.2.3 Color

Role Name	Name	Description	Mult.	Type
Class	Color	Representing a colour according to the colour model	-	-
Attribute	token	The token specifies either an element in a colour table or a colour definition in the RGB space.	1	string
Attribute	transparency	The value specifies the transparency; between 0 (opaque) and 1 (full transparent)	1	double

**9-12.2.2.4 Pen**

Role Name	Name	Description	Mult.	Type
Class	Pen	A tool for drawing lines.	-	-
Attribute	width	The width of the pen in mm.	1	Double
Role	color	The colour of the pen comprises the actual colour and the transparency.	1	Color

**9-12.2.2.5 Pixmap**

Role Name	Name	Description	Mult.	Type
Class	Pixmap	A two dimensional array of pixels defining an image.	-	-
Attribute	reference	A reference to an external definition of the pixmap. This string is a unique identifier within the pixmap section of the portrayal catalogue.	1	string
Role	overrideAll	A colour that override all none fully transparent colours used within the pixmap.	0..1	Color
Association	override	A colour to be replaced by another colour.	0..*	OverrideColor

**9-12.2.2.6 OverrideColor**

Role Name	Name	Description	Mult.	Type
Class	OverrideColor	Association class for the replacement of an existing colour in the pixmap with another colour.	-	-
Role	color	The colour that is used to replace the existing colour in the pixmap.	1	Color

**9-12.2.2.7 CRSType**

Role Name	Name	Description
Type	CRSType	The value describes the type of a CRS. This includes the axes definitions, base line for angle measurement and units for distances.
Enumeration	geographicCRS	A geographic CRS with axis latitude and longitude measured in degrees. Angles are defined clockwise from the true north direction. Distances will be measured in metres.
Enumeration	portrayalCRS	A Cartesian coordinate system with the y-axis pointing upwards. Units on the axes and for distances are millimetres. Angles are measured in degrees clockwise from the positive y-axis. Note that the actual output device may have a different orientation of the y-axis.
Enumeration	localCRS	A Cartesian coordinate system originated at a local geometry. Units on the axes and for distances are millimetres. Angles are measured in degrees clockwise from the positive y-axis. See explanations for details.
Enumeration	lineCRS	A none-Cartesian coordinate system where the x-axis is following the geometry of a curve and the y-axis is perpendicular to the x-axis (positive to the left of the x-axis) Units on the axes and for distances are millimetres. Angles are measured in degrees clockwise from the positive y-axis.

The following figure shows how the local CRS are defined for the different types of geometry.

From left to right:

- Local CRS for point geometry  
Note: for multi points the local CRS is repeated at each point.
- Local CRS for curve geometry. The origin of the coordinate system can be any point of the line. This point can be defined by the absolute or relative distance from the start of the

line. The x-axis is directed in the direction of the tangent at the tangency point and the y-axis is oriented perpendicular to this direction.

- Local CRS for surface geometry. For the boundary the same rules apply as for curve geometry. For the interior of the surface a coordinate system is used that has axes parallel to the Portrayal CRS. The origin can be an arbitrary point that is constant relative to the surface. This point can be outside the surface.

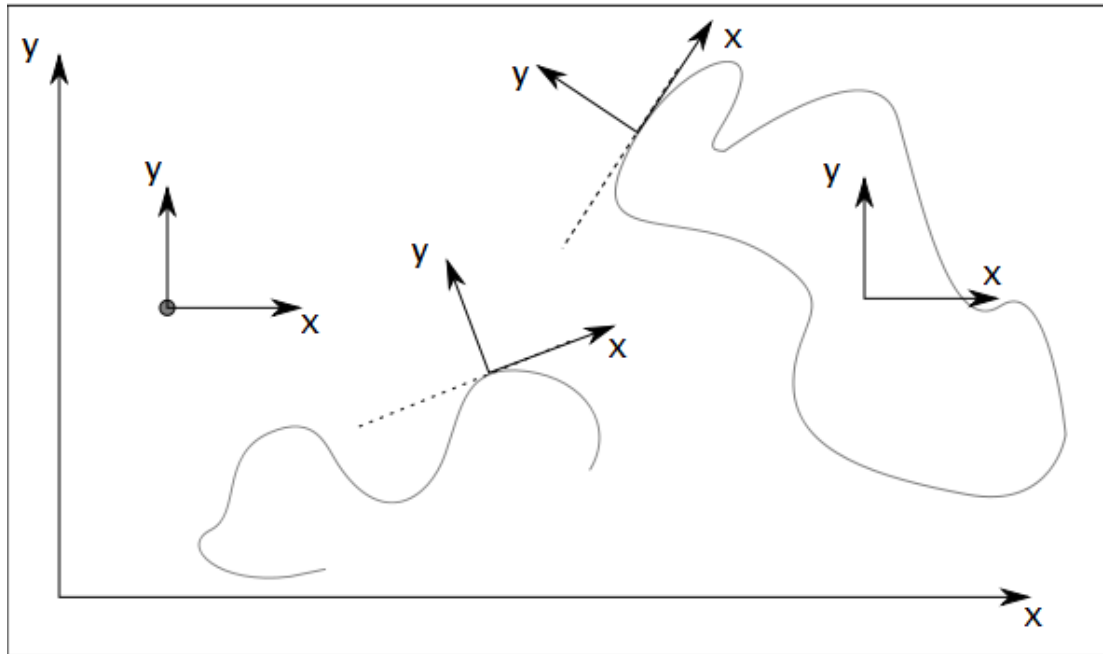


Figure 9-13 — Local CRS

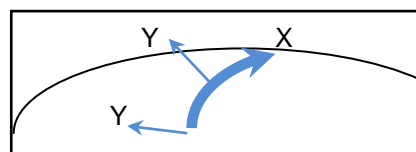


Figure 9-14 — Line CRS

9-12.2.2.8 Sector

Role Name	Name	Description	Mult.	Type
Class	Sector	Region of the Cartesian plane enclosed by two radii.	-	-
Attribute	startAngle	The direction of the radius that defines the beginning of the sector	1	double
Attribute	angularDistance	The angular distance of the sector measured in degrees. Positive values means clockwise, negative values means anti-clockwise.	1	double

9-12.2.2.9 Path

Role Name	Name	Description	Mult.	Type
Class	Path	The definition of linear geometry by a	-	-



		composition of segments.		
Role	segment	The segments that build up the path.	1..*	PathSegment

Paths can be closed or not closed. A closed path has coinciding start and end points. Segments are connected until a path is closed. In that case the next segment is not connected and the path contains multiple sub-paths.

#### 9-12.2.2.10 PathSegment

Role Name	Name	Description	Mult.	Type
Class	PathSegment	Abstract base class for all segments that can be used within a path.	-	-

#### 9-12.2.2.11 Polyline

Role Name	Name	Description	Mult.	Type
Class	Polyline	A segment defining its geometry by a series of points.	-	-
Role	point	The segments the build up the path.	2..*	Point

#### 9-12.2.2.12 Arc

Role Name	Name	Description	Mult.	Type
Class	Arc	Abstract base class for segments describing arcs of a circle.	-	-

#### 9-12.2.2.13 Arc3Points

Role Name	Name	Description	Mult.	Type
Class	Arc3Points	A segment describing an arc of a circle that is defined by 3 points. The points must not be colinear.	-	-
Attribute	startPoint	The point where the arc starts.	1	Point
Attribute	medianPoint	An arbitrary point on the arc.	1	Point
Attribute	endPoint	The point where the arc ends.	1	Point

#### 9-12.2.2.14 ArcByRadius

Role Name	Name	Description	Mult.	Type
Class	ArcByRadius	A segment describing an arc of a circle that is defined by the centre of the arc and a radius. Optional the arc can be restricted by a sector.	-	-
Attribute	center	The centre of the arc.	1	Point
Attribute	sector	The sector defining where the arc starts and end. If not present the arc is a full circle.	0..1	Sector
Attribute	radius	The radius of the circle.	1	double

#### 9-12.2.2.15 Annulus

Role Name	Name	Description	Mult.	Type
Class	Annulus	A ring-shaped region bounded by two concentric circles. Optional it can be enclosed by two radii of the circle	-	-
Attribute	center	The centre of the arc.	1	Point
Attribute	innerRadius	The radius of the smaller circle. If not present the segment describes a sector of a circle.	0..1	double
Attribute	outerRadius	The radius of the larger circle.	1	double
Attribute	sector	The sector of an annulus segment	0..1	Sector

### 9-13.3. The Symbol package

#### 9-13.3.1 Model

This package contains the model of a symbol. Note that the definition of the symbol graphic itself is not the subject of this model. This will be defined in external files according to the SVG 1.1 recommendation.

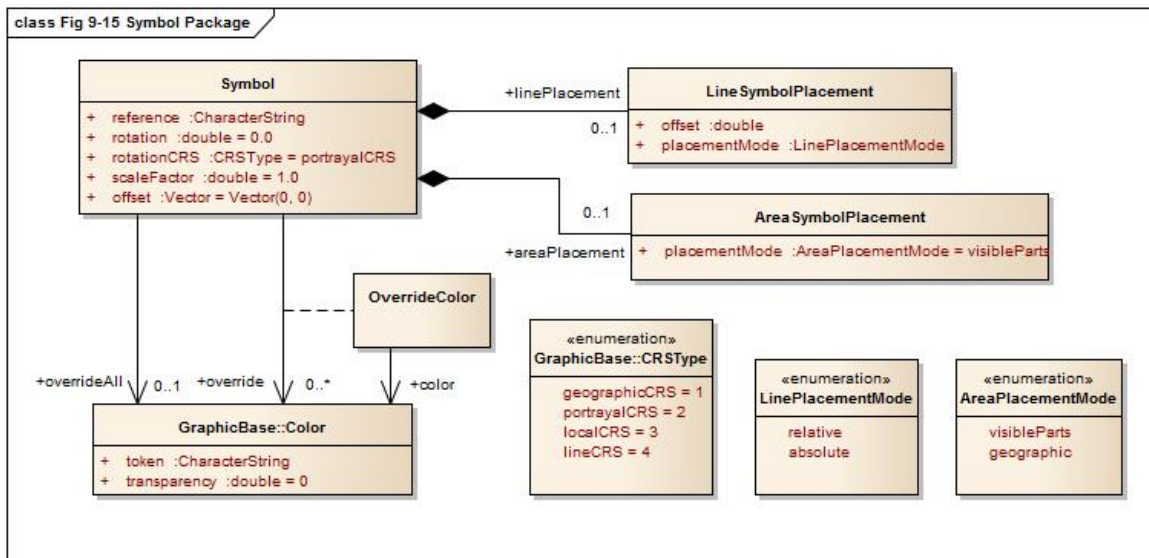


Figure 9-15 — Symbol Package

#### 9-13.3.1.1. Symbol

Role Name	Name	Description	Mult.	Type
Class	Symbol	A two dimensional graphical element.	-	-
Attribute	reference	A reference to an external definition of the symbol graphic. This is an unique identifier in the symbol section of the portrayal catalogue.	1	string
Attribute	rotation	The rotation angle of the symbol. The default value is 0.	1	double
Attribute	rotationCRS	Specifies the coordinate reference system for the rotation.	1	GraphicsBase::CRSType
Attribute	scaleFactor	The factor by which the original symbol graphic is scaled. The default value is 1.	1	double
Attribute	offset	The shift of the symbols position from the position of the geometry. The default value is the vector with length equals to 0.	1	GraphicsBase::Vector
Role	overrideAll	A colour that override all none fully transparent colours used within the symbol.	0..1	GraphicsBase::Color
Association	override	A colour to be replaced by another colour.	0..*	OverrideColor
Role	linePlacement	Information where on a line the symbol should be placed.	0..1	LineSymbolPlacement
Role	areaPlacement	Defines the placement of a symbol within an area.	0..1	AreaSymbolPlacement

#### 9-13.3.1.2. OverrideColor

Role Name	Name	Description	Mult.	Type
Class	OverrideColor	Association class for the replacement of an	-	-

		existing colour in the symbol.		
Role	color	The colour that is used to replace an existing colour in the symbol.	1	Color

#### 9-13.3.1.3. LineSymbolPlacement

Role Name	Name	Description	Mult.	Type
Class	LineSymbolPlacem ent	Defines the placement of a symbol along a line	-	-
Attribute	offset	The offset from the start of the curve.	1	double
Attribute	placementMode	The mode that defines how the offset is to be interpreted.	1	LinePlacementMod e

#### 9-13.3.1.4. AreaSymbolPlacement

Role Name	Name	Description	Mult.	Type
Class	AreaSymbolPlaceme nt	Defines the placement of a symbol within an area.	-	-
Attribute	placementMode	The mode that defines how the symbol has to be placed.	1	AreaPlacementMod e

#### 9-13.3.1.5. LinePlacementMode

Role Name	Name	Description
Type	LinePlacementMod e	Defines the type of placement of a symbol along a line.
Enumeration	relative	The offset has to be interpreted as homogenous coordinates, 0 for the start and 1 for the end of the curve.
Enumeration	absolute	The offset is the distance from the start of the curve.

#### 9-13.3.1.6. AreaPlacementMode

Role Name	Name	Description
Type	AreaPlacementMod e	Defines the type of placement of a symbol within an area.
Enumeration	visibleParts	The symbol has to be placed at a representative position in each visible part of the surface.
Enumeration	geographic	The symbol has to be placed at a representative position of the geographic object.

### 9-13.4. The LineStyles package

9-13.4.1. Model

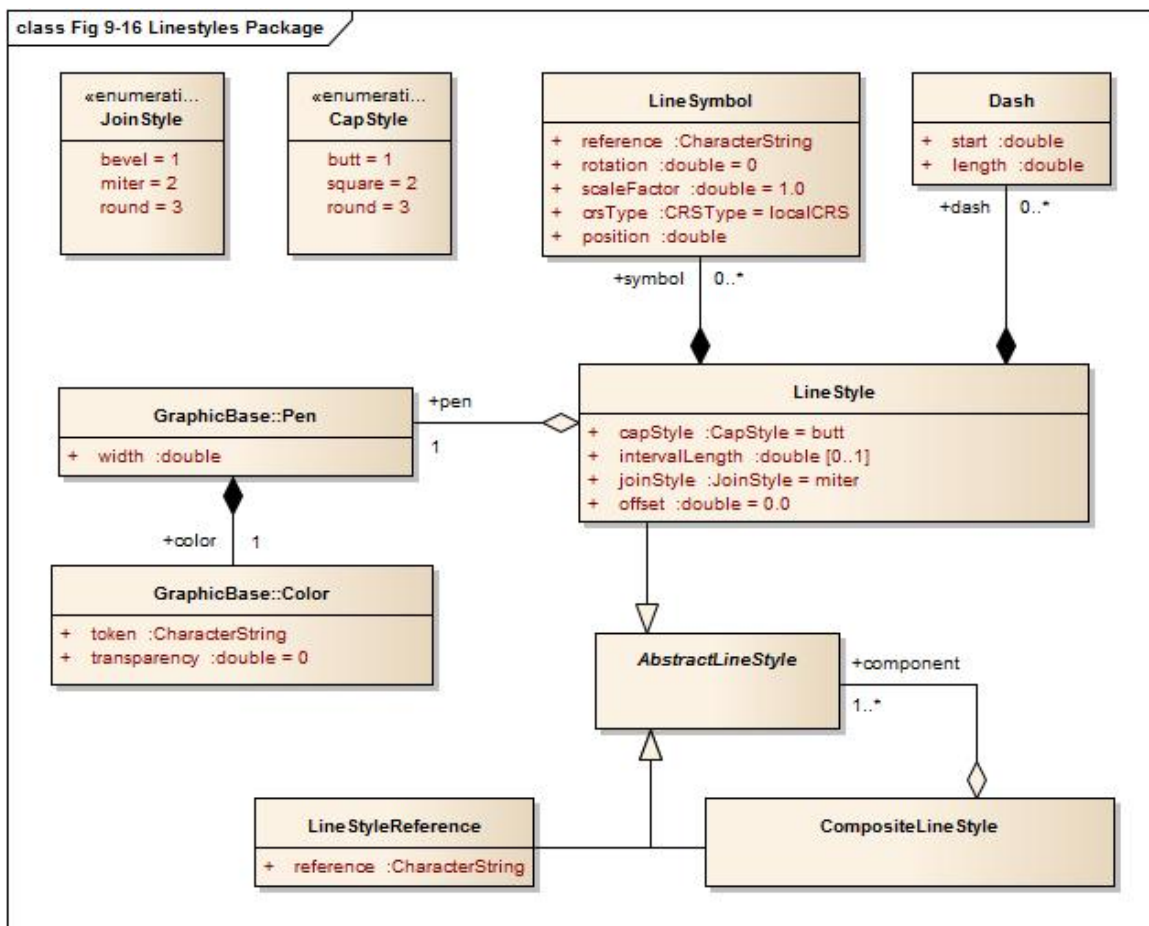


Figure 9-16 — Symbol Package

9-13.4.1.1. AbstractLineStyle

Role Name	Name	Description	Mult.	Type
Class	AbstractLineStyle	Abstract base class for graphics to depict line geometry.	-	-

9-13.4.1.2. LineStyle

Role Name	Name	Description	Mult.	Type
Class	LineStyle	A style for line geometry either solid or dashed.	-	-
Attribute	offset	An offset perpendicular to the direction of the line. The value refers to the y-axis of the line CRS. (positive to the left, mm)	1	double
Attribute	capStyle	The decoration that is applied where a line segment ends.	1	CapStyle
Attribute	joinStyle	The decoration that is applied where two line segments meet.	1	JoinStyle
Attribute	intervalLength	The length of a repeating interval of the line style along the x-axis of the line CRS (units in mm) If not defined the line style describes a solid line	0..1	double
Role	dash	The dashes of a dashed line style.	0..*	Dash
Role	pen	The pen used for drawing the line.	1	Pen
Role	symbol	Symbols placed along the line	0..*	LineSymbol

**9-13.4.1.3. Dash**

Role Name	Name	Description	Mult.	Type
Class	Dash	A single dash in a repeating line pattern.	-	-
Attribute	start	The start of the dash measured from the start of the repeating interval, along the x-axis of the line CRS (units in mm)	1	double
Attribute	length	The length of the dash along the x-axis of the line CRS (units in mm)	1	double

**9-13.4.1.4. LineSymbol**

Role Name	Name	Description	Mult.	Type
Class	LineSymbol	A symbol placed along a line in a repeating pattern.	-	-
Attribute	reference	A reference to an external definition of the symbol graphic. This refers to an identifier of a catalogue item.	1	string
Attribute	rotation	The rotation angle of the symbol. The default value is 0.	1	double
Attribute	scaleFactor	The scale factor of the symbol. The default is 1.0.	1	double
Attribute	crsType	The type of the CRS where the symbol has to be transformed to. Possible values are localCRS and lineCRS.	1	CRSType
Attribute	position	The position of the symbol measured from the start of the repeating interval, along the x-axis of the line CRS (units in mm)	1	double



**9-13.4.1.5. CompositeLineStyle**


Role Name	Name	Description	Mult.	Type
Class	CompositeLineStyle	A line style made with an aggregation of other line styles.		
Role	component	The components of the composite line style.	1..*	AbstractLineStyle

**9-13.4.1.6. LineStyleReference**




Role Name	Name	Description	Mult.	Type
Class	LineStyleReference	A line style defined in an external file.		
Attribute	reference	The reference to the external definition of the line style. This is a unique identifier in the line style section of the portrayal catalogue.	1	string

**9-13.4.1.7. JoinStyle**

Role Name	Name	Description
Type	JoinStyle	The decoration that is applied where two line segments meet.
Enumeration	bevel	
Enumeration	miter	

Enumeration	round	
-------------	-------	---

#### 9-13.4.1.8. CapStyle

Role Name	Name	Description
Type	CapStyle	The decoration that is applied where a line segment ends.
Enumeration	butt	
Enumeration	square	
Enumeration	round	

#### 9-13.5. The AreaFills package

### 9-13.5.1 Model

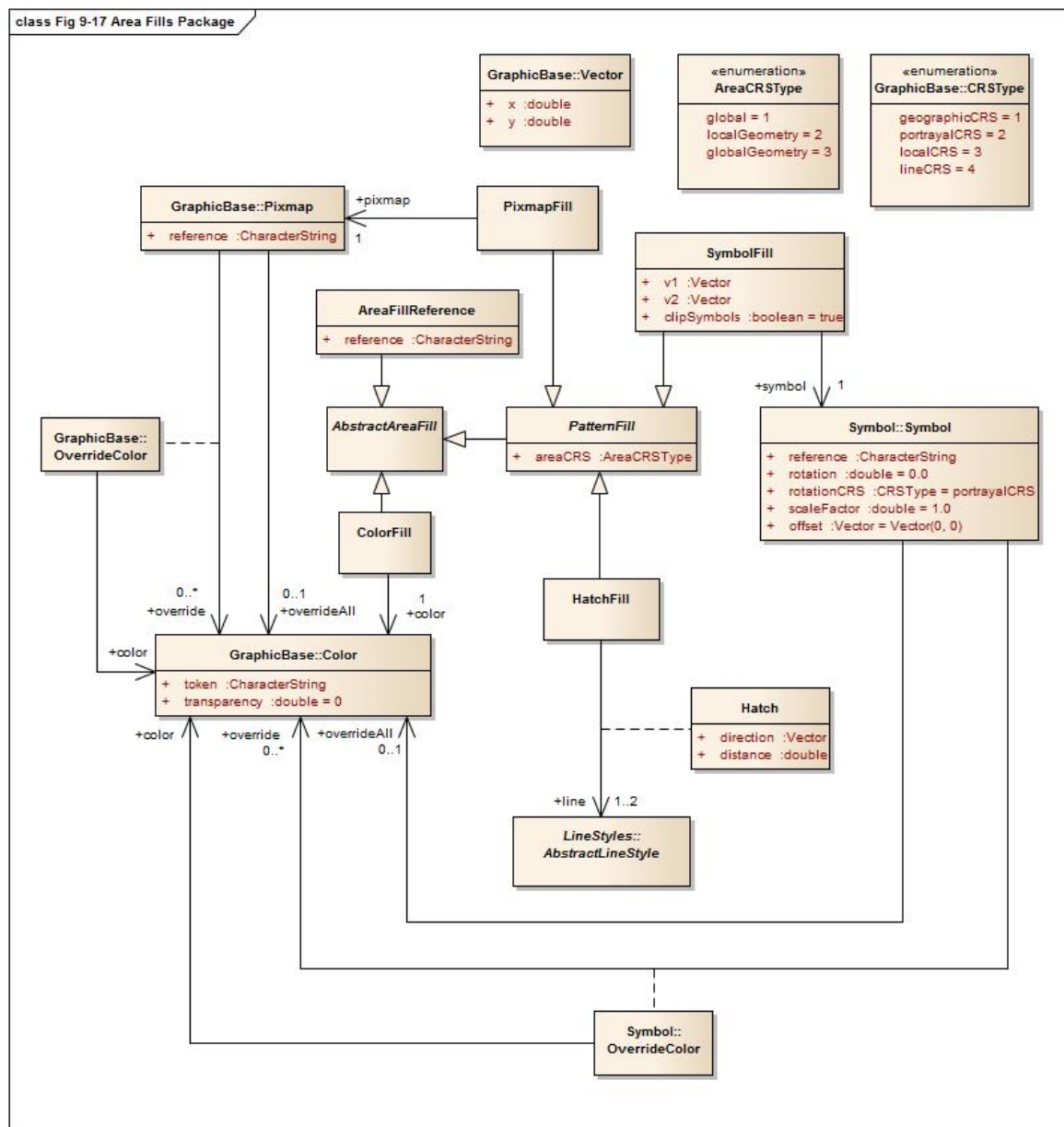


Figure 9-17 — Area Fills Package

#### 9-13.5.1.1. AbstractAreaFill

Role Name	Name	Description	Mult.	Type
Class	AbstractAreaFill	Abstract base class for graphics that are designed to fill an area.	-	-

#### 9-13.5.1.2. PatternFill

Role Name	Name	Description	Mult.	Type
Class	PatternFill	Abstract base class for pattern area fills.	-	-
Attribute	areaCRS	Coordinate reference system which defines the origin of the pattern.	1	AreaCRSType

#### 9-13.5.1.3. AreaFillReference

Role Name	Name	Description	Mult.	Type
Class	AreaFillReference	An area fill defined in an external file.	-	-
Attribute	reference	The reference to the external definition. This is an unique identifier in the area fill section of the portrayal catalogue.	1	string

#### 9-13.5.1.4. ColorFill

Role Name	Name	Description	Mult.	Type
Class	ColorFill	Class defining a solid colour fill for an area.	-	-
Role	color	References the colour and transparency for the colour fill.	1	Color

#### 9-13.5.1.5. PixmapFill

Role Name	Name	Description	Mult.	Type
Class	PixmapFill	Pattern fill where the pattern is defined by a pixmap.	-	-
Role	pixmap	The pixmap defining the pattern.	1	Pixmap

#### 9-13.5.1.6. SymbolFill

Role Name	Name	Description	Mult.	Type
Class	SymbolFill	Pattern fill where the pattern is defined by repeated symbols.	-	-
Role	symbol	The symbol used for the pattern.	1	Symbol
Attribute	v1	Defines the offset of the next symbol in the first dimension of the pattern according to the local CRS	1	Vector
Attribute	v2	Defines the offset of the next symbol in the second dimension of the pattern according to the local CRS.	1	Vector

#### 9-13.5.1.7. HatchFill

Role Name	Name	Description	Mult.	Type
Class	HatchFill	Defining a pattern made of one or two sets of parallel lines.	-	-
Association	Hatch	A set of parallel lines.	1	Hatch

#### 9-13.5.1.8. Hatch

Role Name	Name	Description	Mult.	Type
Class	Hatch	A set of parallel lines used for an area fill pattern.		
Attribute	direction	The vector defining the direction of the set of lines.	1	Vector
Attribute	distance	The distance between the lines measured perpendicular to the direction.	1	double
Role	line	The line style used for each hatch line	1..2	LineStyle::AbstractLineStyle

#### 9-13.5.1.9. AreaCRSType

Role Name	Name	Description
Type	PatternCRS	Describes how a fill patter is referenced.



Enumeration	global	Anchor point is consistent with a location on the drawing device e.g. starting with the corner of the screen. As screen pans the pattern will appear to shift/move through the object on screen.
Enumeration	localGeometry	Anchor point is consistent with the local geometry of the object being depicted, e.g. the upper left corner of the object. Patterns of adjacent objects may not match.
Enumeration	globalGeometry	The anchor point of the fill pattern is defined at a common location such that patterns remain consistent relative to all area objects.

## 9-13.6. The Text package

### 9-13.6.1 Overview

The text package contains the types necessary for the depiction of text. This includes fonts. In this model fonts may be described by characteristics or referenced by name. Two types of text instructions are supported:

- Text relative to a point
- Text that will be drawn along a linear geometry

### 9-13.6.2 Fonts

A font is a set of typefaces. A typeface is the artistic representation or interpretation of characters; it is the way the type looks.

This standard supports two methods of defining fonts, the first describes a font by four attributes and let the system find a best match to an actual font available on the graphic system. The second method is referencing an external font file. The format of this file must conform to the 'True Type Font' standard and must be included in the the Portrayal Catalogue.

9-13.6.3 Model

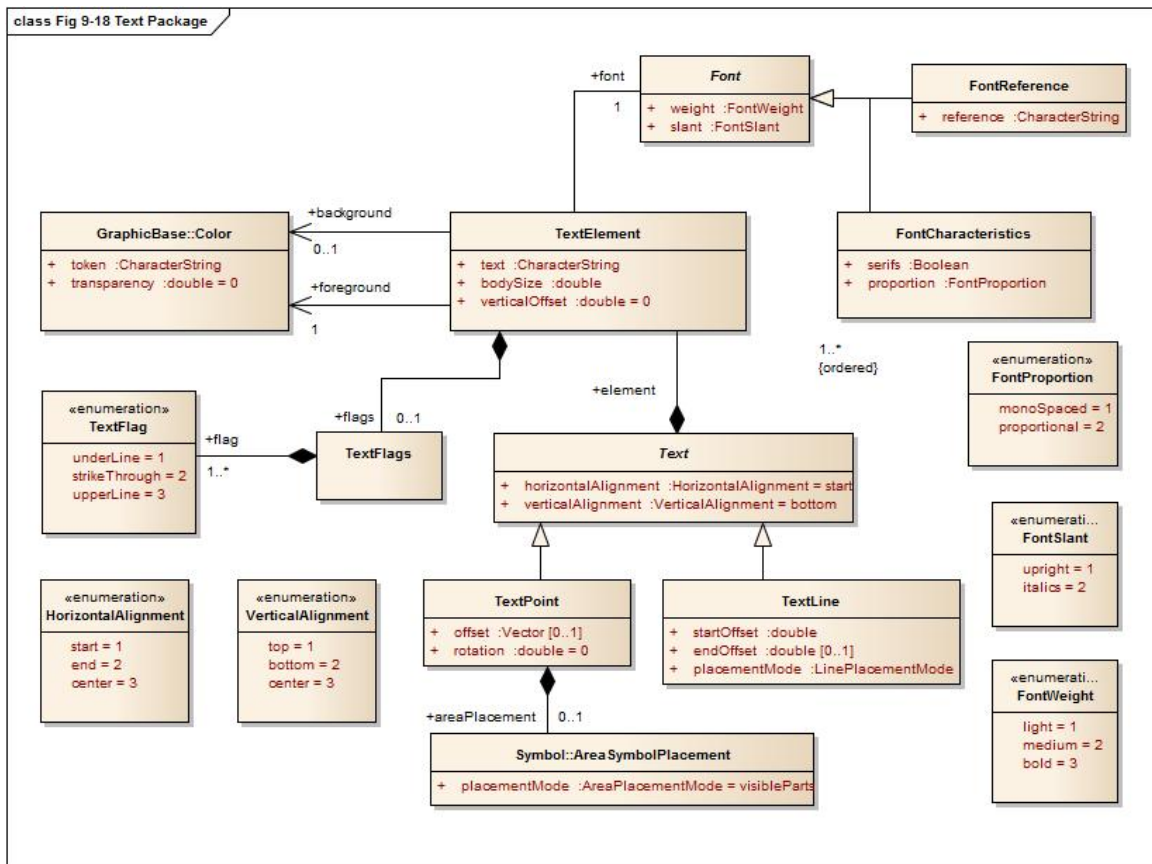


Figure 9-18 — Text Package

9-13.6.3.1. Font

Role Name	Name	Description	Mult.	Type
Class	Font	Abstract base class for fonts.	-	-

9-13.6.3.2. FontCharacteristics

Role Name	Name	Description	Mult.	Type
Class	FontCharacteristics	Class describing the main characteristics of a font.	-	-
Attribute	serifs	Describes whether the typefaces contain serifs or not.	1	bool
Attribute	weight	Describes the thickness of the typefaces.	1	FontWeight
Attribute	slant	Describes the slant of the typefaces.	1	FontSlant
Attribute	proportion	Describes whether all typefaces in the font have an individual width or a fixed width.	1	FontProportion

9-13.6.3.3. FontReference

Role Name	Name	Description	Mult.	Type
Class	FontReference	Class referencing a font from an external source.	-	-
Attribute	reference	The identifier for the external file within the portrayal catalogue.	1	string

**9-13.6.3.4. Text**

Role Name	Name	Description	Mult.	Type
Class	Text	The abstract base class of graphic elements for depicting text. The text is composed of elements.	-	-
Attribute	horizontalAlignment	Specifies how the text is horizontally aligned relative to the anchor point. Default = start.	1	HorizontalAlignment
Attribute	verticalAlignment	Specifies how the text is vertically aligned relative to the anchor point. Default = bottom	1	VerticalAlignment
Role	element	The ordered list of text elements.	1..*	TextElement

**9-13.6.3.5. TextPoint**

Role Name	Name	Description	Mult.	Type
Class	TextPoint	A graphic element for depicting text relative to a point.	-	-
Attribute	offset	Specifies the offset from the anchor point with respect to the portrayal CRS.	0..1	GraphicsBase::Vector
Attribute	rotation	Specifies the rotation angle relative to the portrayal CRS. Default = 0.	1	double
Role	areaPlacement	Describes the placement of the text when the geometry is a surface.	0..1	Symbol::AreaSymbolPlacement

**9-13.6.3.4. TextLine**

Role Name	Name	Description	Mult.	Type
Class	TextLine	A graphic element for depicting text along linear geometry.	-	-
Attribute	startOffset	This offset specifies the anchor point on the line.	1	double
Attribute	endOffset	This offset specifies the stop point of the text at the line. If present the startOffset does not specifies an anchor point but the start point of the text. The text will evenly be spaced between the two positions. Horizontal alignment has no effect in this case.	0..1	double
Attribute	placementMode	Specifies how the offsets have to be interpreted.	1	Symbol::LinePlacementMode

**9-13.6.3.5. TextFlags**

Role Name	Name	Description	Mult.	Type
Class	TextFlags	A container for text flags	-	-
Role	flag	A text flag.	1..*	TextFlag

**9-13.6.3.6. TextElement**

Role Name	Name	Description	Mult.	Type
Class	TextElement	A sub element of a graphic text.	-	-
Attribute	text	The text to be depicted	1	String
Attribute	bodySize	This property describes the size with which the text will be depicted.	1	Double
Attribute	verticalOffset	The vertical offset in mm between the base line of the text element and the base line of the text. This can be used to generate sub- or superscripts. Default = 0.	1	Double

Role	flags	Flags describe special properties of the text element like underline etc.	0..1	TextFlags
Role	font	The font used for the depiction of the text element.	1	Font
Role	foreground	The colour used to depict the glyphs.	1	Color
Role	background	The colour to fill the rectangle surrounding the text element before the text is depicted. If not given there is no fill (transparent)	0..1	Color

#### 9-13.6.3.7. FontSlant

Role Name	Name	Description
Type	FontSlant	The slant used within a font
Enumeration	upright	Typefaces are upright.
Enumeration	italics	Typefaces are cursive.

#### 9-13.6.3.8. FontWeight

Role Name	Name	Description
Type	FontWeigth	The thickness used for the typefaces in a font.
Enumeration	light	Typefaces are depicted as thin (standard)
Enumeration	medium	Typefaces are depicted thicker as 'Light' but not as thin as 'Bold'
Enumeration	bold	Typefaces are depicted more prominent ( <b>Bold</b> )

#### 9-13.6.3.9. FontProportion

Role Name	Name	Description
Type	FontProportion	The values describe how the width of the typefaces in a font is defined.
Enumeration	monoSpaces	All typefaces in a font have the same width, also known as 'typewriter' fonts.
Enumeration	proportional	Any typeface in the font as its individual width.

#### 9-13.6.3.10. TextFlag

Role Name	Name	Description
Type	TextFlag	The values describe some effects used when the text will be depicted. The values can be combined.
Enumeration	underLine	Text is depicted with a line under the text.
Enumeration	strikeThrough	Text is depicted struck through, a line goes through the text.
Enumeration	upperLine	Text is depicted with a line above the text

#### 9-13.6.3.11. VerticalAlignment

Role Name	Name	Description
Type	VerticalAlignment	Describes the text placement relative to the anchor point in vertical direction.
Enumeration	top	The anchor point is at the top of the text.
Enumeration	bottom	The anchor point is at the bottom of the text.
Enumeration	center	The anchor point is at the (vertical) centre of the text.

#### 9-13.6.3.12. HorizontalAlignment

Role Name	Name	Description
Type	HorizontalAlignment	Describes the text placement relative to the anchor point in horizontal direction.
Enumeration	start	The anchor point is at the start of the text.
Enumeration	end	The anchor point is at the end of the text.
Enumeration	center	The anchor point is at the (horizontal) centre of the text.

## **9-13.7. The Coverage package**

### **9-13.7.1 Overview**

The coverage package contains the types for the depiction of a Coverage. This portrayal is applicable to the portrayal of numeric Coverage values. Three types of coverage portrayals are supported:

- Colour
- Numeric Annotation
- Symbol Annotation

### **9-13.7.2 Ranges**

Ranges are used to control how portrayal is assigned to the values in a Coverage. These make use of the S-100\_NumericRange complex type which is defined in S-100 Part 1 Conceptual Schema Language. The Numeric Range type allows for various range definitions with different closure options.

### **9-13.7.3 Lookup Table**

The CoverageFill class carries an ordered list of lookup entries. Each of these entries carries a range used to evaluate a match by testing if the coverage value matches the range. The first lookup entry with a matching range is used to apply up to one of each type of portrayal (colour, numeric annotation or a symbol) to the coverage element. This allows for example to fill a cell in a grid with a colour and assign a numeric or symbol annotation to the cell as well.

### 9-13.7.4 Model

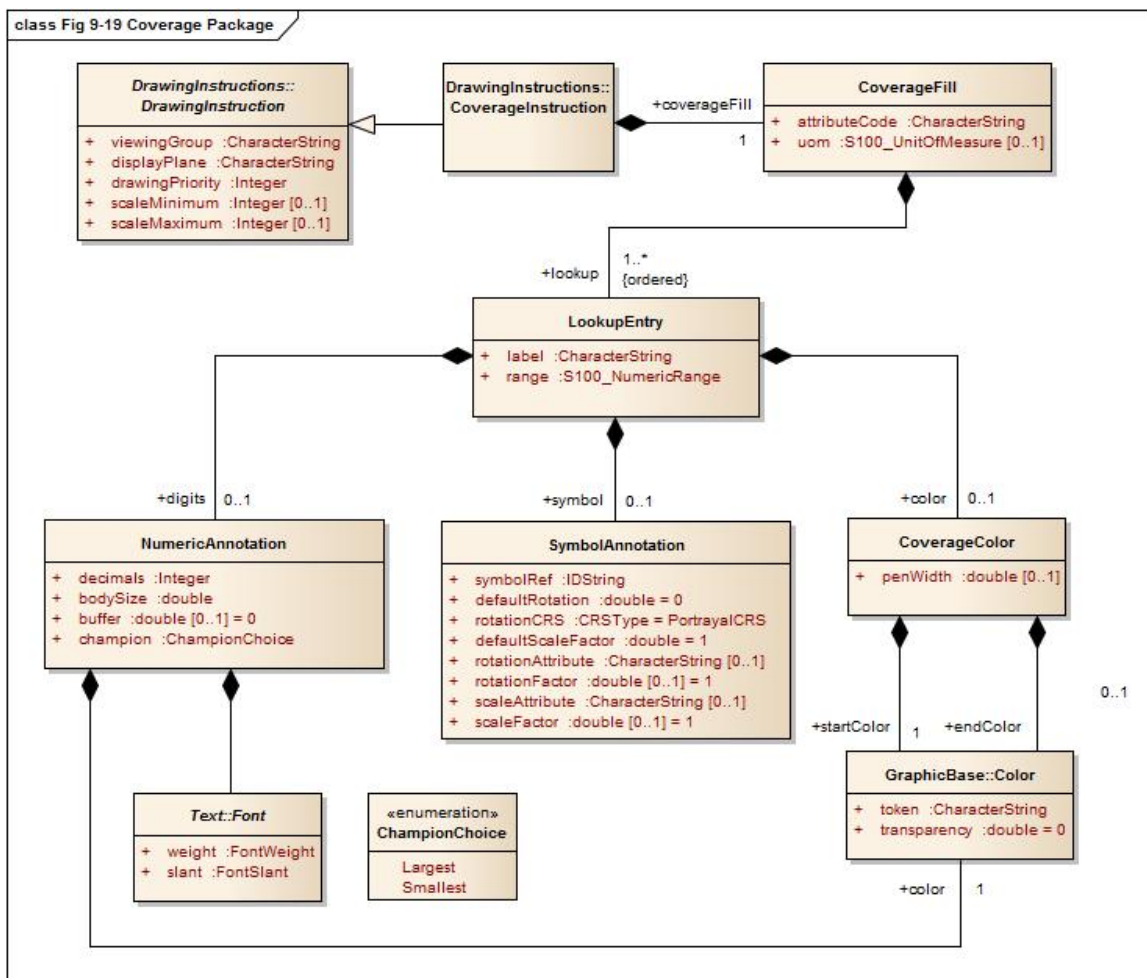


Figure 9-19 — Coverage Package

#### 9-13.7.4.1. CoverageFill

Role Name	Name	Description	Mult.	Type
Class	CoverageFill	A class to fill a Coverage with using a lookup table to match a value or range of values and assign colour, numeric or symbol annotations.	-	-
Attribute	attributeCode	Code of coverage attribute value to match.	1	CharacterString
Attribute	uom	Unit of measure. If not given the values in the range are assumed to be same units as the coverage attribute values.	0..1	S100_UnitOfMeasure
Role	lookup	Lookup table. The entries are ordered and processed on a first match basis.	1..*	LookupEntry

#### 9-13.7.4.2. LookupEntry

Role Name	Name	Description	Mult.	Type
Class	LookupEntry	An entry in a lookup table used to assign portrayal to coverage elements.	-	-
Attribute	label	String used as a display label or legend field.	1	CharacterString
Attribute	range	Value range definition. Can be a single value, open or closed range etc. See S-100 Part 1 Conceptual Schema Language for details.	1	S100_NumericRange

Role	color	The color to assign to the matching range. Can be a single color or a color ramp.	0..1	CoverageColor
Role	digits	Display the value as numeric digits.	0..1	NumericAnnotation
Role	symbol	Display a symbol.	0..1	SymbolAnnotation

#### 9-13.7.4.3. CoverageColor

Role Name	Name	Description	Mult.	Type
Class	CoverageColor	A class to fill a Coverage with color	-	-
Attribute	penWidth	Optional pen width to apply for dot color used for discrete points.	0..1	double
Role	startColor	The color to assign to the matching range or to use as start point in a color ramp when 'endColor' is defined.	1	GraphicBase::Color
Role	endColor	The color to use as stop point in a color ramp. The range of values is spread linearly across the range of colors from 'startColor' to 'endColor' to produce a gradient effect.	0..1	GraphicBase::Color

#### 9-13.7.4.4. NumericAnnotation

Role Name	Name	Description	Mult.	Type
Class	NumericAnnotation	A class for numeric textual annotations of values in a Coverage.	-	-
Attribute	decimals	Number of decimal digits to show in subscript.	1	Integer
Attribute	bodySize	This property describes the size with which the text will be depicted.	1	double
Attribute	buffer	Buffer to apply for collision detection in presentation units. Default=0	1	double
Attribute	champion	Enumeration to indicate which value to display in the event of a collision.	1	ChampionChoice
Role	font	Font information to use for display of numeric values across a coverage. Text::Font is a choice of either FontCharacteristics or FontReference.	1	Text::Font
Role	color	Color to draw the numeric annotation.	1	GraphicBase::Color

#### 9-13.7.4.5. SymbolAnnotation

Role Name	Name	Description	Mult.	Type
Class	SymbolAnnotation	A class for symbol annotations of values in a coverage.	-	-
Attribute	symbolRef	Reference to the symbol to apply. Catalogue id.	1	IDString
Attribute	defaultRotation	A default symbol rotation. Applies when rotation attribute not defined. Default=0	0..1	double
Attribute	rotationCRS	Specifies the coordinate reference system for the rotation. Default=PortrayalCRS	1	GraphicsBase::CRSType
Attribute	defaultScale	A default symbol scale factor. Applies when scale attribute not defined. Default=1	1	double
Attribute	rotationAttribute	The attribute code of the Coverage Attribute to use for the symbol rotation value.	0..1	CharacterString
Attribute	rotationFactor	Used to adjust the 'rotationAttribute' value by multiplication before applying. Default 1.0	0..1	double
Attribute	scaleAttribute	The attribute code of the Coverage attribute to use for scaling the symbol size.	0..1	CharacterString
Attribute	scaleFactor	Used to adjust the 'scaleAttribute' value by multiplication before applying. Default 1.0	0..1	double

For schema definition see A.2 Symbol Definition Schema

## 9-14 The portrayal library

### 9-14.1. Overview

- Machine readable
- A file/directory structure with a catalogue file
- Files for pixmaps, symbols, complex line styles, areafills, fonts and colour profiles
- XSLT templates in separate files
- Model and schema for the catalogue included

### 9-14.2. Structure

```
Root ---- (contains the catalogue named "portrayal_catalogue.xml")
|
|-- Pixmaps (contains XML files describing pixmaps)
|
|-- ColorProfiles (contains XML files with colour profiles and CSS2 style sheets)
|
|-- Symbols (contains SVG files with symbols)
|
|-- LineStyles (contains XML files with line styles)
|
|-- AreaFills (contains XML files area fills)
|
|-- Fonts (contains TrueType font files)
|
|-- Rules (contains XSLT files with templates)
```

### 9-14.3. Model of the Catalogue





		Catalogue is intended.		
Attribute	version	The version of the product the Catalogue is defined for.	1	string
Role	pixmap	Container of XML Pixmap file references	1	Pixmap
Role	colorProfiles	Container of XML Colour Profile file references	1	ColorProfiles
Role	symbols	Container of SVG Symbol file references	1	Symbols
Role	lineStyles	Container of XML Line Style file references	1	LineStyles
Role	areaFills	Container of XML Area Fill file references	1	AreaFills
Role	fonts	Container of True Type font references	1	Fonts
Role	viewingGroups	Container of viewing group definitions	1	ViewingGroups
Role	foundationMode	The definition of the foundation of the portrayal	1	FoundationMode
Role	viewingGroupLayers	Container of viewing group layers.	1	ViewingGroupLayers
Role	displayModes	Container of display mode definitions	1	DisplayModes
Role	displayPlanes	Container of display plane definitions	1	DisplayPlanes
Role	context	Container of context parameter definitions	1	Context
Role	rules	Container of XSLT rule file references	1	Rules

### 9-14.3.2 CatalogItem

Role Name	Name	Description	Mult.	Type
Class	CatalogItem	An abstract base class for components of the Catalogue	-	-
Attribute	id	A unique identifier of the catalogue item	1	string
Role	description	Meta Data common to each Catalogue Item. There can be descriptions in different languages.	0..*	Description

### 9-14.3.3 ExternalFile

Role Name	Name	Description	Mult.	Type
Class	ExternalFile	A catalogue item that defines the reference to an external file.	-	-
Subtype of	CatalogItem	See CatalogItem	-	-
Attribute	fileName	The name of the file	1	string
Attribute	fileType	The type of the file	1	FileType
Attribute	fileFormat	The format of the file	1	FileFormat

### 9-14.3.4 Description

Role Name	Name	Description	Mult.	Type
Class	Description	Language specific information about an item	-	-
Attribute	language	A language identifier code. ISO 639-2/T alpha-3 code (eng – English, fra – French, deu - German)	1	string
Attribute	name	An optional name of an item in the identified language	0..1	string
Attribute	description	The language specific description of the item	1	string

### 9-14.3.5 Pixmap

Role Name	Name	Description	Mult.	Type
Class	Pixmap	A container of pixmap file references	-	-
Role	pixmap	The file reference. The type is XML.	0..*	ExternalFile

**9-14.3.6 ColorProfiles**

Role Name	Name	Description	Mult.	Type
Class	ColorProfiles	A container of colour profile file references	-	-
Role	colorProfile	The file reference. The type is XML.	0..*	ExternalFile

**9-14.3.7 Symbols**

Role Name	Name	Description	Mult.	Type
Class	Symbols	A container of Symbol file references	-	-
Role	symbol	The file reference. The type is SVG.	0..*	ExternalFile

**9-14.3.8 LineStyles**

Role Name	Name	Description	Mult.	Type
Class	LineStyle	A container of Line Style file references	-	-
Role	lineStyle	The file reference. The type is XML.	0..*	ExternalFile

**9-14.3.9 AreaFills**

Role Name	Name	Description	Mult.	Type
Class	AreaFills	A container of Area Fill file references	-	-
Role	lineStyle	The file reference. The type is XML.	0..*	ExternalFile

**9-14.3.10 ViewingGroups**

Role Name	Name	Description	Mult.	Type
Class	ViewingGroups	A container of Viewing Group definitions	-	-
Role	viewingGroup	Definition of a specific Viewing Group	1..*	ViewingGroup

**9-14.3.11 ViewingGroup**

Role Name	Name	Description	Mult.	Type
Class	ViewingGroup	A Viewing Group name and definition	-	-
Subtype of	CatalogItem	See CatalogItem	-	-

**9-14.3.12 FoundationMode**

Role Name	Name	Description	Mult.	Type
Class	FoundationMode	A set of viewing groups that forms the foundation of the portrayal and cannot be removed from the display.	-	-
Role	viewingGroup	Viewing group of the foundation mode.	0..*	ViewingGroup

**9-14.3.13 ViewingGroupLayers**

Role Name	Name	Description	Mult.	Type
Class	ViewingGroupLayers	A container of Viewing Group Layers.	-	-
Role	layer	Definition of a specific viewing group layer.	0..*	ViewingGroupLayer

**9-14.3.14 ViewingGroupLayer**

Role Name	Name	Description	Mult.	Type
-----------	------	-------------	-------	------

Class	ViewingGroupLayer	A set of Viewing groups which are intended to switch on or off in an application.	-	-
Subtype of	CatalogItem	See CatalogItem	-	-
Role	viewingGroup	Viewing Group of the layer	1..*	ViewingGroup

### 9-14.3.15 DisplayModes

Role Name	Name	Description	Mult.	Type
Class	DisplayModes	A container of Display Mode definitions	-	-
Role	displayMode	Definition of a Display Mode	1..*	DisplayMode

### 9-14.3.16 DisplayMode

Role Name	Name	Description	Mult.	Type
Class	DisplayMode	A set of Viewing Layers to switch on or off in an application-	-	-
Subtype of	CatalogItem	See CatalogItem	-	-
Role	viewingGroupLayer	Viewing Group Layer included in this Display Mode	1..*	ViewingGroupLayer

### 9-14.3.17 DisplayPlanes

Role Name	Name	Description	Mult.	Type
Class	DisplayPlanes	A container of Display Plane definitions	-	-
Role	displayPlane	Definition of a Display Plane.	1..*	DisplayPlane

### 9-14.3.18 DisplayPlane

Role Name	Name	Description	Mult.	Type
Class	DisplayPlane	A Display Plane name and definition	-	-
Subtype of	CatalogItem	See CatalogItem	-	-

### 9-14.3.19 Context

Role Name	Name	Description	Mult.	Type
Class	Context	A container of Context Parameters	-	-
Role	parameter	Context Parameter	0..*	ContextParameter

### 9-14.3.20 ContextParameter

Role Name	Name	Description	Mult.	Type
Class	ContextParameter	A Context Parameter name and definition	-	-
Subtype of	CatalogItem	See CatalogItem	-	-
Attribute	type	The data type of the Parameter	1	ParameterType
Attribute	default	A default value for the Parameter	1	string

### 9-14.3.21 Rules

Role Name	Name	Description	Mult.	Type
Class	Rules	A container of XSLT rule file references	-	-
Role	ruleFile	Reference to an XSLT file containing template rules.	1..*	RuleFile

**9-14.3.22 RuleFile**

Role Name	Name	Description	Mult.	Type
Class	RuleFile	XSLT rule file reference	-	-
Subtype of	ExternalFile	See ExternalFile	-	-
Attribute	ruleType	The type of the templates within the rule file. There can be more than one top level rule which can be selected in an application to allow different portrayal of the data.	1	RuleType

**9-14.3.23 ParameterType**

Role Name	Name	Description
Type	ParameterType	Choice of Parameter Types
Enumeration	boolean	A Boolean value
Enumeration	integer	An integer number
Enumeration	double	A floating point number.
Enumeration	string	A character string.
Enumeration	date	A date according to the gregorian calendar.

**9-14.3.24 FileFormat**

Role Name	Name	Description
Type	FileFormat	The format of an external file
Enumeration	xml	
Enumeration	svg	
Enumeration	xslt	
Enumeration	ttf	

**9-14.3.25 FileType**

Role Name	Name	Description
Type	FileType	The type of an external file
Enumeration	font	A font file.
Enumeration	areaFill	A file describing an area fill.
Enumeration	lineStyle	A file describing a line style.
Enumeration	symbol	A file describing a symbol.
Enumeration	colorProfile	A file describing a colour profile.
Enumeration	pixmap	A file describing a pixmap.
Enumeration	rules	A file containing XSLT rules.

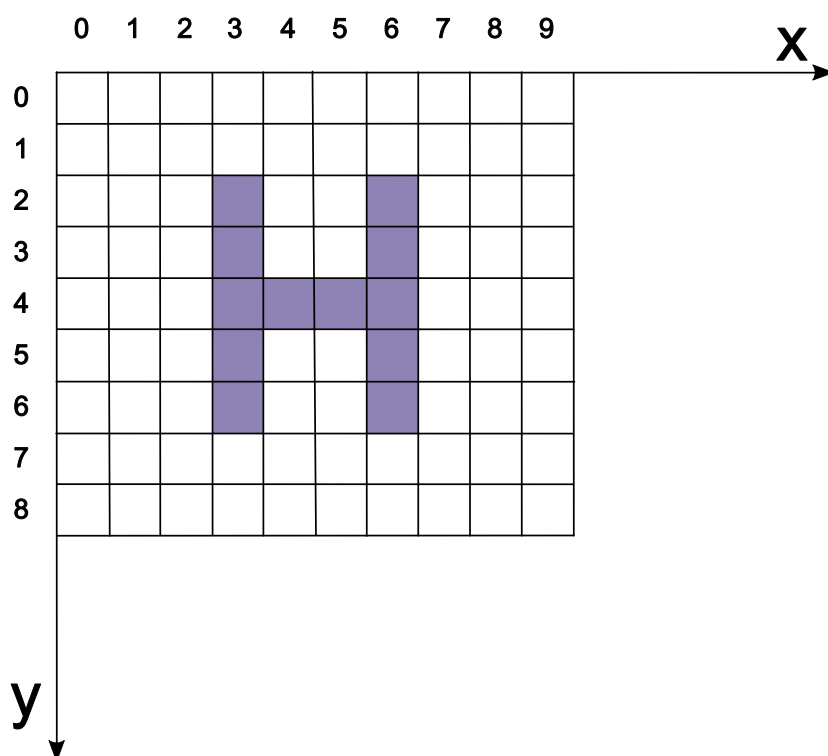
**9-14.3.26 RuleType**

Role Name	Name	Description
Type	RuleType	The type of templates within an XSLT file.
Enumeration	topLevelTemplate	The rule file contains a top level template
Enumeration	subTemplate	The rule file contains templates that are used or called by other templates

For schema definition see A.4 Portrayal Catalogue Schema

**9-14.4. Schema for pixmap files**

A pixmap is a two dimensional array of pixels defining an image. This schema allows to encode pixmaps that can be then be referenced e.g. from pixmap area fills. The coordinate system for the pixmap is different than other coordinate systems in this standard. The y-axis is directed downwards and the origin is in the upper left corner of the pixmap.



The graphic above shows a simple pixmap with width 10 pixel and height 9 pixel. Most of the pixels are transparent (here white) some pixels are coloured.

The style defines a simple type for the colour identifier:

```
<xs:simpleType name="ColorId">
  <xs:restriction base="xs:string">
    <xs:minLength value="1"></xs:minLength>
    <xs:maxLength value="3"></xs:maxLength>
    <xs:pattern value="[a-zA-Z0-9_]+"></xs:pattern>
  </xs:restriction>
</xs:simpleType>
```

This describes a token 1 to 3 characters long that can contain digits, alpha characters or the underscore. It is used to identify a colour in the colour map.

The next type is a complex type for a pixel:

```
<xs:complexType name="Pixel">
  <xs:simpleContent>
    <xs:extension base="ColorId">
      <xs:attribute name="x" type="xs:nonNegativeInteger" use="required"/>
      <xs:attribute name="y" type="xs:nonNegativeInteger" use="required"/>
    </xs:extension>
  </xs:simpleContent>
</xs:complexType>
```

It extends the colour identifier and adds two attributes for the coordinate of the pixel according to the pixmap coordinate system.

Each pixmap contains a colour map; a list of colour definitions bundled with a colour identifier. Two types are defined in the schema one for the colour map item and one for the colour map.

```

<xs:complexType name="ColorMapItem">
  <xs:complexContent>
    <xs:extension base="s100Symbol:Color">
      <xs:attribute name="id" type="ColorId" use="required"/>
    </xs:extension>
  </xs:complexContent>
</xs:complexType>

<xs:complexType name="ColorMap">
  <xs:sequence>
    <xs:element name="color" type="ColorMapItem" minOccurs="1" maxOccurs="unbounded"/>
  </xs:sequence>
</xs:complexType>

```

Note: The color definition is taken from the S-100 symbol definition schema. That allows using colour token from a colour profile or direct sRGB colour definitions. Transparency can be defined here as well.

The last type defined is the complex type for the pixmap itself.

```

<xs:complexType name="Pixmap">
  <xs:sequence>
    <xs:element name="description" type="xs:string" minOccurs="0" maxOccurs="1"/>
    <xs:element name="width" type="xs:positiveInteger"/>
    <xs:element name="height" type="xs:positiveInteger"/>
    <xs:element name="colorMap" type="ColorMap">
      <xs:key name="colorKey">
        <xs:selector xpath="color"/>
        <xs:field xpath="@id"/>
      </xs:key>
    </xs:element>
    <xs:element name="background" type="ColorId"/>
    <xs:element name="pixel" type="Pixel" minOccurs="0" maxOccurs="unbounded"/>
  </xs:sequence>
</xs:complexType>

```

It defines an optional description element and mandatory elements for width and height. Furthermore it defines an element for the colour map, an element for the background colour and the any number of pixel elements. The background colour is implicitly used for all pixels that are not defined by a pixel element. Note that there is a key element to ensure that colour identifiers are unique.

Finally the root element is defined:

```

<xs:element name="pixmap" type="Pixmap">
  <xs:keyref refer="colorKey" name="pixelRef">
    <xs:selector xpath="pixel"/>
    <xs:field xpath="."/>
  </xs:keyref>
  <xs:keyref refer="colorKey" name="backgroundRef">
    <xs:selector xpath="background"/>
    <xs:field xpath="."/>
  </xs:keyref>
</xs:element>

```

```

</xs:keyref>
<xs:unique name="positionUnique">
  <xs:selector xpath="pixel"/>
  <xs:field xpath="@x"/>
  <xs:field xpath="@y"/>
</xs:unique>
</xs:element>

```

The keyref element are there for ensure the referential integrity of the colour identifier used in the pixel and background element. The unique element ensures that no pixel is defined more than ones.

A complete pixmap file for the example above looks like:

```

<?xml version="1.0" encoding="UTF-8"?>
<pixmap xmlns:xsi="http://www.w3.org/2001/XMLSchema-instance"
  xsi:noNamespaceSchemaLocation="S100Pixmap.xsd">
  <description>Test pixmap showing a capital H in faint magenta.</description>
  <width>10</width>
  <height>9</height>
  <colorMap>
    <color id="_" transparency="1.0">#000000</color>
    <color id="M">#8F83B6</color>
  </colorMap>
  <background>_</background>
  <pixel x="3" y="2">M</pixel>
  <pixel x="3" y="3">M</pixel>
  <pixel x="3" y="4">M</pixel>
  <pixel x="3" y="5">M</pixel>
  <pixel x="3" y="6">M</pixel>
  <pixel x="4" y="4">M</pixel>
  <pixel x="5" y="4">M</pixel>
  <pixel x="6" y="2">M</pixel>
  <pixel x="6" y="3">M</pixel>
  <pixel x="6" y="4">M</pixel>
  <pixel x="6" y="5">M</pixel>
  <pixel x="6" y="6">M</pixel>
</pixmap>

```



## Appendix 9-A (normative)

### XML Schemas

#### 9-A-1. Input Schema

```

<?xml version="1.0" encoding="UTF-8"?>
<xs:schema xmlns="http://www.ihp.int/S100BaseModel" xmlns:xs="http://www.w3.org/2001/XMLSchema"
targetNamespace="http://www.ihp.int/S100BaseModel">
  <!-- Simple non empty alpha numeric string type for references -->
  <xs:simpleType name="IDString">
    <xs:restriction base="xs:string">
      <xs:minLength value="1"/>
      <xs:pattern value="[0-9a-zA-Z_]*"/>
    </xs:restriction>
  </xs:simpleType>

  <xs:simpleType name="Orientation">
    <xs:restriction base="xs:string">
      <xs:enumeration value="Forward"/>
      <xs:enumeration value="Reverse"/>
    </xs:restriction>
  </xs:simpleType>

  <xs:simpleType name="BoundaryType">
    <xs:restriction base="xs:string">
      <xs:enumeration value="Begin"/>
      <xs:enumeration value="End"/>
    </xs:restriction>
  </xs:simpleType>

  <xs:simpleType name="InterpolationType">
    <xs:restriction base="xs:string">
      <xs:enumeration value="None"/>
      <xs:enumeration value="Linear"/>
      <xs:enumeration value="Loxodromic"/>
      <xs:enumeration value="CircularArc3Points"/>
      <xs:enumeration value="Geodesic"/>
      <xs:enumeration value="CircularArcCenterPointWithRadius"/>
      <xs:enumeration value="Elliptical"/>
      <xs:enumeration value="Conic"/>
    </xs:restriction>
  </xs:simpleType>

  <xs:simpleType name="GeometricPrimitive">
    <xs:restriction base="xs:string">
      <xs:enumeration value="None"/>
      <xs:enumeration value="Point"/>
      <xs:enumeration value="MultiPoint"/>
      <xs:enumeration value="Curve"/>
      <xs:enumeration value="Surface"/>
      <xs:enumeration value="Coverage"/>
      <xs:enumeration value="Complex"/>
    </xs:restriction>
  </xs:simpleType>

  <xs:simpleType name="Direction">
    <xs:restriction base="xs:string">
      <xs:enumeration value="+"/>
      <xs:enumeration value="-"/>
    </xs:restriction>
  </xs:simpleType>

```

```

    </xs:restriction>
  </xs:simpleType>

  <xs:complexType name="Coordinate2D">
    <xs:sequence>
      <xs:element name="x" type="xs:double"/>
      <xs:element name="y" type="xs:double"/>
    </xs:sequence>
  </xs:complexType>

  <xs:complexType name="Coordinate3D">
    <xs:complexContent>
      <xs:extension base="Coordinate2D">
        <xs:sequence>
          <xs:element name="z" type="xs:double"/>
        </xs:sequence>
      </xs:extension>
    </xs:complexContent>
  </xs:complexType>

  <xs:group name="Coordinate">
    <xs:choice>
      <xs:element name="Coordinate2D" type="Coordinate2D"/>
      <xs:element name="Coordinate3D" type="Coordinate3D"/>
    </xs:choice>
  </xs:group>

  <xs:complexType name="InformationAssociation">
    <xs:attribute name="informationRef" type="IDString" use="required"/>
    <xs:attribute name="role" type="xs:string" use="required"/>
  </xs:complexType>

  <xs:complexType name="FeatureAssociation">
    <xs:attribute name="featureRef" type="IDString" use="required"/>
    <xs:attribute name="role" type="xs:string" use="required"/>
  </xs:complexType>

  <xs:complexType name="SpatialRelation">
    <xs:attribute name="ref" type="IDString" use="required"/>
    <xs:attribute name="scaleMinimum" type="xs:positiveInteger"/>
    <xs:attribute name="scaleMaximum" type="xs:positiveInteger"/>
  </xs:complexType>

  <xs:complexType name="MaskedRelation">
    <xs:complexContent>
      <xs:extension base="SpatialRelation">
        <xs:attribute name="mask" type="xs:boolean" default="false"/>
      </xs:extension>
    </xs:complexContent>
  </xs:complexType>

  <xs:complexType name="BoundaryRelation">
    <xs:complexContent>
      <xs:extension base="SpatialRelation">
        <xs:attribute name="boundaryType" type="BoundaryType" use="required"/>
      </xs:extension>
    </xs:complexContent>
  </xs:complexType>

  <xs:complexType name="CurveRelation">

```

```

    <xs:complexContent>
      <xs:extension base="MaskedRelation">
        <xs:attribute name="orientation" type="Orientation" use="required"/>
      </xs:extension>
    </xs:complexContent>
  </xs:complexType>

  <xs:group name="CurveRelations">
    <xs:choice>
      <xs:element name="Curve" type="CurveRelation"/>
      <xs:element name="CompositeCurve" type="CurveRelation"/>
    </xs:choice>
  </xs:group>

  <xs:group name="SpatialRelations">
    <xs:choice>
      <xs:element name="Point" type="MaskedRelation"/>
      <xs:element name="PointSet" type="MaskedRelation"/>
      <xs:element name="Surface" type="MaskedRelation"/>
      <xs:group ref="CurveRelations"/>
    </xs:choice>
  </xs:group>

  <xs:complexType name="Object" abstract="true">
    <xs:attribute name="id" type="IDString" use="required"/>
  </xs:complexType>

  <xs:complexType name="Point" abstract="true">
    <xs:complexContent>
      <xs:extension base="Object">
        <xs:sequence>
          <xs:group ref="Coordinate"/>
        </xs:sequence>
      </xs:extension>
    </xs:complexContent>
  </xs:complexType>

  <xs:complexType name="MultiPoint" abstract="true">
    <xs:complexContent>
      <xs:extension base="Object">
        <xs:sequence>
          <xs:group ref="Coordinate" minOccurs="1" maxOccurs="unbounded"/>
        </xs:sequence>
      </xs:extension>
    </xs:complexContent>
  </xs:complexType>

  <xs:complexType name="SegmentBase" abstract="true">
    <xs:sequence>
      <xs:element name="ControlPoint" type="Coordinate2D" minOccurs="1"
maxOccurs="unbounded"/>
    </xs:sequence>
    <xs:attribute name="interpolation" type="InterpolationType" use="required"/>
  </xs:complexType>

  <xs:complexType name="Segment">
    <xs:complexContent>
      <xs:restriction base="SegmentBase">
        <xs:sequence>

```

```

        <xs:element name="ControlPoint" type="Coordinate2D" minOccurs="2"
maxOccurs="unbounded"/>
    </xs:sequence>
</xs:restriction>
</xs:complexContent>
</xs:complexType>

<xs:complexType name="ArcByCenterPointBase" abstract="true">
    <xs:complexContent>
        <xs:restriction base="SegmentBase">
            <xs:sequence>
                <xs:element name="ControlPoint" type="Coordinate2D" minOccurs="1" maxOccurs="1"/>
            </xs:sequence>
            <xs:attribute name="interpolation" type="InterpolationType" use="required"
fixed="CircularArcCenterPointWithRadius"/>
        </xs:restriction>
    </xs:complexContent>
</xs:complexType>

<xs:complexType name="ArcByCenterPoint">
    <xs:complexContent>
        <xs:extension base="ArcByCenterPointBase">
            <xs:attribute name="radius" type="xs:double" use="required"/>
            <xs:attribute name="startAngle" type="xs:double" use="required"/>
            <xs:attribute name="angularDistance" type="xs:double" use="required"/>
        </xs:extension>
    </xs:complexContent>
</xs:complexType>

<xs:complexType name="CircleByCenterPoint">
    <xs:complexContent>
        <xs:extension base="ArcByCenterPointBase">
            <xs:attribute name="radius" type="xs:double" use="required"/>
            <xs:attribute name="direction" type="Direction" default="+"/>
        </xs:extension>
    </xs:complexContent>
</xs:complexType>

<xs:group name="Segments">
    <xs:choice>
        <xs:element name="Segment" type="Segment"/>
        <xs:element name="ArcByCenterPoint" type="ArcByCenterPoint"/>
        <xs:element name="CircleByCenterPoint" type="CircleByCenterPoint"/>
    </xs:choice>
</xs:group>

<xs:complexType name="Curve" abstract="true">
    <xs:complexContent>
        <xs:extension base="Object">
            <xs:sequence>
                <xs:element name="Boundary" type="BoundaryRelation" minOccurs="0"
maxOccurs="2"/>
                <xs:group ref="Segments" minOccurs="1" maxOccurs="unbounded"/>
            </xs:sequence>
        </xs:extension>
    </xs:complexContent>
</xs:complexType>

<xs:complexType name="CompositeCurve" abstract="true">
    <xs:complexContent>

```

```

    <xs:extension base="Object">
      <xs:sequence>
        <xs:group ref="CurveRelations" minOccurs="1" maxOccurs="unbounded"/>
      </xs:sequence>
    </xs:extension>
  </xs:complexContent>
</xs:complexType>

<xs:complexType name="Ring">
  <xs:group ref="CurveRelations" minOccurs="1" maxOccurs="unbounded"/>
</xs:complexType>

<xs:complexType name="Surface" abstract="true">
  <xs:complexContent>
    <xs:extension base="Object">
      <xs:sequence>
        <xs:element name="OuterRing" type="Ring" minOccurs="1"/>
        <xs:element name="InnerRing" type="Ring" minOccurs="0" maxOccurs="unbounded"/>
      </xs:sequence>
    </xs:extension>
  </xs:complexContent>
</xs:complexType>

<xs:complexType name="Information" abstract="true">
  <xs:complexContent>
    <xs:extension base="Object"/>
  </xs:complexContent>
</xs:complexType>

<xs:complexType name="Feature" abstract="true">
  <xs:complexContent>
    <xs:extension base="Object">
      <xs:sequence>
        <xs:group ref="SpatialRelations" minOccurs="0" maxOccurs="unbounded"/>
      </xs:sequence>
      <xs:attribute name="primitive" type="GeometricPrimitive" use="required"/>
    </xs:extension>
  </xs:complexContent>
</xs:complexType>
</xs:schema>

```

## 9-B-2. Symbol Definition Schema

```

<?xml version="1.0" encoding="UTF-8"?>
<xs:schema xmlns="http://www.ihp.int/S100SymbolDefinition"
  xmlns:xs="http://www.w3.org/2001/XMLSchema"
  xmlns:s100CSL="http://www.ihp.int/S100ConceptualSchema"
  targetNamespace="http://www.ihp.int/S100SymbolDefinition">
  <xs:import namespace="http://www.ihp.int/S100ConceptualSchema"
    schemaLocation="S100CSL.xsd"/>

  <!-- THE GRAPHICS BASE PACKAGE -->
  <!-- A string with at least 1 character starting with an alpha numerical character used as
  identifier within this catalogue -->
  <xs:simpleType name="IdString">
    <xs:restriction base="xs:string">
      <xs:minLength value="1"/>
      <xs:pattern value="[0-9a-zA-Z]*"/>
    </xs:restriction>
  </xs:simpleType>

```

<!-- A color token (either a string starting with an alpha character followed by alpha numeric characters or a hash and three hex numbers like #AA44A8) -->

```
<xs:simpleType name="ColorToken">
  <xs:restriction base="xs:string">
    <xs:minLength value="1"/>
    <xs:pattern value="[a-zA-Z][0-9a-zA-Z]*#[0-9A-Fa-f]{6}"/>
  </xs:restriction>
</xs:simpleType>
```

```
<!-- Enumeration CRSType -->
<xs:simpleType name="Interval01">
  <xs:restriction base="xs:double">
    <xs:minInclusive value="0.0"/>
    <xs:maxInclusive value="1.0"/>
  </xs:restriction>
</xs:simpleType>
```

```
<!-- Enumeration CRSType -->
<xs:simpleType name="CRSType">
  <xs:restriction base="xs:string">
    <xs:enumeration value="GeographicCRS"/>
    <xs:enumeration value="PortrayalCRS"/>
    <xs:enumeration value="LocalCRS"/>
    <xs:enumeration value="LineCRS"/>
  </xs:restriction>
</xs:simpleType>
```

```
<!-- Class Point -->
<xs:complexType name="Point">
  <xs:sequence>
    <xs:element name="x" type="xs:double"/>
    <xs:element name="y" type="xs:double"/>
  </xs:sequence>
</xs:complexType>
```

```
<!-- Class Vector -->
<xs:complexType name="Vector">
  <xs:sequence>
    <xs:element name="x" type="xs:double"/>
    <xs:element name="y" type="xs:double"/>
  </xs:sequence>
</xs:complexType>
```

```
<!-- Class Sector -->
<xs:complexType name="Sector">
  <xs:sequence>
    <xs:element name="startAngle" type="xs:double"/>
    <xs:element name="angularDistance" type="xs:double"/>
  </xs:sequence>
</xs:complexType>
```

```
<!-- Class Color -->
<xs:complexType name="Color">
  <xs:simpleContent>
    <xs:extension base="ColorToken">
      <xs:attribute name="transparency" type="Interval01" default="0.0"/>
    </xs:extension>
  </xs:simpleContent>
</xs:complexType>
```

```

<!-- Class OverrideColor -->
<xs:complexType name="OverrideColor">
  <xs:sequence>
    <xs:element name="override" type="Color"/>
    <xs:element name="color" type="Color"/>
  </xs:sequence>
</xs:complexType>

<!-- Class Pen -->
<xs:complexType name="Pen">
  <xs:sequence>
    <xs:element name="color" type="Color"/>
  </xs:sequence>
  <xs:attribute name="width" type="xs:double" use="required"/>
</xs:complexType>

<!-- Class Pixmap -->
<xs:complexType name="Pixmap">
  <xs:sequence>
    <xs:element name="overrideAll" type="Color" minOccurs="0" maxOccurs="1"/>
    <xs:element name="override" type="OverrideColor" minOccurs="0" maxOccurs="unbounded"/>
  </xs:sequence>
  <xs:attribute name="reference" type="IdString" use="required"/>
</xs:complexType>

<!-- Class Polyline -->
<xs:complexType name="Polyline">
  <xs:sequence>
    <xs:element name="point" type="Point" minOccurs="2" maxOccurs="unbounded"/>
  </xs:sequence>
</xs:complexType>

<!-- Class Arc3Points -->
<xs:complexType name="Arc3Points">
  <xs:sequence>
    <xs:element name="startPoint" type="Point"/>
    <xs:element name="medianPoint" type="Point"/>
    <xs:element name="endPoint" type="Point"/>
  </xs:sequence>
</xs:complexType>

<!-- Class ArcByRadius -->
<xs:complexType name="ArcByRadius">
  <xs:sequence>
    <xs:element name="center" type="Point"/>
    <xs:element name="sector" type="Sector" minOccurs="0" maxOccurs="1"/>
    <xs:element name="radius" type="xs:double"/>
  </xs:sequence>
</xs:complexType>

<!-- Class Annulus -->
<xs:complexType name="Annulus">
  <xs:sequence>
    <xs:element name="center" type="Point"/>
    <xs:element name="innerRadius" type="xs:double" minOccurs="0" maxOccurs="1"/>
    <xs:element name="outerRadius" type="xs:double"/>
    <xs:element name="sector" type="Sector" minOccurs="0" maxOccurs="1"/>
  </xs:sequence>
</xs:complexType>

```

```

<!-- group for segments -->
<xs:group name="Segment">
  <xs:choice>
    <xs:element name="polyline" type="Polyline"/>
    <xs:element name="arc3Points" type="Arc3Points"/>
    <xs:element name="arcByRadius" type="ArcByRadius"/>
    <xs:element name="annulus" type="Annulus"/>
  </xs:choice>
</xs:group>

<!-- Class Path -->
<xs:complexType name="Path">
  <xs:sequence>
    <xs:group ref="Segment" minOccurs="1" maxOccurs="unbounded"/>
  </xs:sequence>
</xs:complexType>

<!-- THE SYMBOL PACKAGE -->
<!-- Enumeration LinePlacementMode -->
<xs:simpleType name="LinePlacementMode">
  <xs:restriction base="xs:string">
    <xs:enumeration value="Relative"/>
    <xs:enumeration value="Absolute"/>
  </xs:restriction>
</xs:simpleType>

<!-- Enumeration AreaPlacementMode -->
<xs:simpleType name="AreaPlacementMode">
  <xs:restriction base="xs:string">
    <xs:enumeration value="VisibleParts"/>
    <xs:enumeration value="Geographic"/>
  </xs:restriction>
</xs:simpleType>

<!-- Class LineSymbolPlacement -->
<xs:complexType name="LineSymbolPlacement">
  <xs:sequence>
    <xs:element name="offset" type="xs:double"/>
  </xs:sequence>
  <xs:attribute name="placementMode" type="LinePlacementMode" use="required"/>
</xs:complexType>

<!-- Class AreaSymbolPlacement -->
<xs:complexType name="AreaSymbolPlacement">
  <xs:attribute name="placementMode" type="AreaPlacementMode" default="VisibleParts"/>
</xs:complexType>

<!-- Class Symbol -->
<xs:complexType name="Symbol">
  <xs:sequence>
    <xs:element name="offset" type="Vector" minOccurs="0" maxOccurs="1"/>
    <xs:element name="overrideAll" type="Color" minOccurs="0" maxOccurs="1"/>
    <xs:element name="override" type="OverrideColor" minOccurs="0" maxOccurs="unbounded"/>
    <xs:element name="linePlacement" type="LineSymbolPlacement" minOccurs="0"
maxOccurs="1"/>
    <xs:element name="areaPlacement" type="AreaSymbolPlacement" minOccurs="0"
maxOccurs="1"/>
  </xs:sequence>
  <xs:attribute name="reference" type="IdString" use="required"/>

```



```

    <xs:attribute name="rotation" type="xs:double" default="0.0"/>
    <xs:attribute name="rotationCRS" type="CRSType" default="PortrayalCRS"/>
    <xs:attribute name="scaleFactor" type="xs:double" default="1.0"/>
  </xs:complexType>

<!-- THE LINE STYLES PACKAGE -->
<!-- Enumeration JoinStyle -->
<xs:simpleType name="JoinStyle">
  <xs:restriction base="xs:string">
    <xs:enumeration value="Bevel"/>
    <xs:enumeration value="Miter"/>
    <xs:enumeration value="Round"/>
  </xs:restriction>
</xs:simpleType>

<!-- Enumeration JoinStyle -->
<xs:simpleType name="CapStyle">
  <xs:restriction base="xs:string">
    <xs:enumeration value="Butt"/>
    <xs:enumeration value="Square"/>
    <xs:enumeration value="Round"/>
  </xs:restriction>
</xs:simpleType>

<!-- Class Dash -->
<xs:complexType name="Dash">
  <xs:sequence>
    <xs:element name="start" type="xs:double"/>
    <xs:element name="length" type="xs:double"/>
  </xs:sequence>
</xs:complexType>

<!-- Class LineSymbol -->
<xs:complexType name="LineSymbol">
  <xs:sequence>
    <xs:element name="position" type="xs:double"/>
  </xs:sequence>
  <xs:attribute name="reference" type="IdString" use="required"/>
  <xs:attribute name="rotation" type="xs:double" default="0.0"/>
  <xs:attribute name="scaleFactor" type="xs:double" default="1.0"/>
  <xs:attribute name="crsType" type="CRSType" default="LocalCRS"/>
</xs:complexType>

<!-- An abstract base class for linestyle -->
<!-- To be used as anchor element of an substitution group -->
<xs:complexType name="LineStyleBase" abstract="true"/>
<!-- Class LineStyle -->
<xs:complexType name="LineStyle">
  <xs:complexContent>
    <xs:extension base="LineStyleBase">
      <xs:sequence>
        <xs:element name="intervalLength" type="xs:double" minOccurs="0" maxOccurs="1"/>
        <xs:element name="pen" type="Pen"/>
        <xs:element name="dash" type="Dash" minOccurs="0" maxOccurs="unbounded"/>
        <xs:element name="symbol" type="LineSymbol" minOccurs="0"
maxOccurs="unbounded"/>
      </xs:sequence>
      <xs:attribute name="capStyle" type="CapStyle" default="Butt"/>
      <xs:attribute name="joinStyle" type="JoinStyle" default="Miter"/>
      <xs:attribute name="offset" type="xs:double" default="0.0"/>
    </xs:extension>
  </xs:complexContent>
</xs:complexType>

```

```

    </xs:extension>
  </xs:complexContent>
</xs:complexType>

<!-- Class LineStyleReference -->
<xs:complexType name="LineStyleReference">
  <xs:complexContent>
    <xs:extension base="LineStyleBase">
      <xs:attribute name="reference" type="IdString" use="required"/>
    </xs:extension>
  </xs:complexContent>
</xs:complexType>

<!-- Class CompositeLineStyle -->
<xs:complexType name="CompositeLineStyle">
  <xs:complexContent>
    <xs:extension base="LineStyleBase">
      <xs:sequence>
        <xs:group ref="LineStyleGroup" minOccurs="1" maxOccurs="unbounded"/>
      </xs:sequence>
    </xs:extension>
  </xs:complexContent>
</xs:complexType>

<!-- Group LineStyle -->
<xs:group name="LineStyleGroup">
  <xs:choice>
    <xs:element name="lineStyle" type="LineStyle"/>
    <xs:element name="lineStyleReference" type="LineStyleReference"/>
    <xs:element name="compositeLineStyle" type="CompositeLineStyle"/>
  </xs:choice>
</xs:group>

<!-- THE AREA FILLS PACKAGE -->
<!-- Enumeration AreaCRSType -->
<xs:simpleType name="AreaCRSType">
  <xs:restriction base="xs:string">
    <xs:enumeration value="Global"/>
    <xs:enumeration value="LocalGeometry"/>
    <xs:enumeration value="GlobalGeometry"/>
  </xs:restriction>
</xs:simpleType>

<!-- An abstract base class for linestyle -->
<!-- To be used as anchor element of an substitution group -->
<xs:complexType name="AreaFillBase" abstract="true"/>
<!-- Class ColorFill -->
<xs:complexType name="ColorFill">
  <xs:complexContent>
    <xs:extension base="AreaFillBase">
      <xs:sequence>
        <xs:element name="color" type="Color"/>
      </xs:sequence>
    </xs:extension>
  </xs:complexContent>
</xs:complexType>

<!-- Class AreaFillReference -->
<xs:complexType name="AreaFillReference">
  <xs:complexContent>

```

```

    <xs:extension base="AreaFillBase">
      <xs:attribute name="reference" type="IdString" use="required"/>
    </xs:extension>
  </xs:complexContent>
</xs:complexType>

<!-- Class PatternFill -->
<xs:complexType name="PatternFill" abstract="true">
  <xs:complexContent>
    <xs:extension base="AreaFillBase">
      <xs:sequence>
        <xs:element name="areaCRS" type="AreaCRSType"/>
      </xs:sequence>
    </xs:extension>
  </xs:complexContent>
</xs:complexType>

<!-- Class PixmapFill -->
<xs:complexType name="PixmapFill">
  <xs:complexContent>
    <xs:extension base="PatternFill">
      <xs:sequence>
        <xs:element name="pixmap" type="Pixmap"/>
      </xs:sequence>
    </xs:extension>
  </xs:complexContent>
</xs:complexType>

<!-- Class SymbolFill -->
<xs:complexType name="SymbolFill">
  <xs:complexContent>
    <xs:extension base="PatternFill">
      <xs:sequence>
        <xs:element name="symbol" type="Symbol"/>
        <xs:element name="v1" type="Vector"/>
        <xs:element name="v2" type="Vector"/>
      </xs:sequence>
      <xs:attribute name="clipSymbols" type="xs:boolean" default="true"/>
    </xs:extension>
  </xs:complexContent>
</xs:complexType>

<!-- Class Hatch -->
<xs:complexType name="Hatch">
  <xs:sequence>
    <xs:group ref="LineStyleGroup"/>
    <xs:element name="direction" type="Vector"/>
    <xs:element name="distance" type="xs:double"/>
  </xs:sequence>
</xs:complexType>

<!-- Class HatchFill -->
<xs:complexType name="HatchFill">
  <xs:complexContent>
    <xs:extension base="PatternFill">
      <xs:sequence>
        <xs:element name="hatch" type="Hatch" minOccurs="1" maxOccurs="2"/>
      </xs:sequence>
    </xs:extension>
  </xs:complexContent>

```

```

</xs:complexType>

<!-- Group AreaFill -->
<xs:group name="AreaFillGroup">
  <xs:choice>
    <xs:element name="colorFill" type="ColorFill"/>
    <xs:element name="areaFillReference" type="AreaFillReference"/>
    <xs:element name="pixmapFill" type="PixmapFill"/>
    <xs:element name="symbolFill" type="SymbolFill"/>
    <xs:element name="hatchFill" type="HatchFill"/>
  </xs:choice>
</xs:group>

<!-- THE TEXT PACKAGE -->
<!-- Enumeration FontProportion -->
<xs:simpleType name="FontProportion">
  <xs:restriction base="xs:string">
    <xs:enumeration value="MonoSpaced"/>
    <xs:enumeration value="Proportional"/>
  </xs:restriction>
</xs:simpleType>

<!-- Enumeration FontSlant -->
<xs:simpleType name="FontSlant">
  <xs:restriction base="xs:string">
    <xs:enumeration value="Upright"/>
    <xs:enumeration value="Italics"/>
  </xs:restriction>
</xs:simpleType>

<!-- Enumeration FontWeight -->
<xs:simpleType name="FontWeight">
  <xs:restriction base="xs:string">
    <xs:enumeration value="Light"/>
    <xs:enumeration value="Medium"/>
    <xs:enumeration value="Bold"/>
  </xs:restriction>
</xs:simpleType>

<!-- Enumeration TextFlag -->
<xs:simpleType name="TextFlag">
  <xs:restriction base="xs:string">
    <xs:enumeration value="UnderLine"/>
    <xs:enumeration value="StrikeThrough"/>
    <xs:enumeration value="UpperLine"/>
  </xs:restriction>
</xs:simpleType>

<!-- Enumeration HorizontalAlignment -->
<xs:simpleType name="HorizontalAlignment">
  <xs:restriction base="xs:string">
    <xs:enumeration value="Start"/>
    <xs:enumeration value="End"/>
    <xs:enumeration value="Center"/>
  </xs:restriction>
</xs:simpleType>

<!-- Enumeration VerticalAlignment -->
<xs:simpleType name="VerticalAlignment">

```

```

    <xs:restriction base="xs:string">
      <xs:enumeration value="Top"/>
      <xs:enumeration value="Bottom"/>
      <xs:enumeration value="Center"/>
    </xs:restriction>
  </xs:simpleType>

  <!-- Class Font -->
  <xs:complexType name="Font" abstract="true">
    <xs:sequence>
      <xs:element name="weight" type="FontWeight"/>
      <xs:element name="slant" type="FontSlant"/>
    </xs:sequence>
  </xs:complexType>

  <!-- Class FontCharaceristics -->
  <xs:complexType name="FontCharacteristics">
    <xs:complexContent>
      <xs:extension base="Font">
        <xs:sequence>
          <xs:element name="serifs" type="xs:boolean"/>
          <xs:element name="proportion" type="FontProportion"/>
        </xs:sequence>
      </xs:extension>
    </xs:complexContent>
  </xs:complexType>

  <!-- Class FontReference -->
  <xs:complexType name="FontReference">
    <xs:complexContent>
      <xs:extension base="Font">
        <xs:attribute name="reference" type="IdString" use="required"/>
      </xs:extension>
    </xs:complexContent>
  </xs:complexType>

  <!-- Group Font -->
  <xs:group name="Font">
    <xs:choice>
      <xs:element name="fontCharacteristics" type="FontCharacteristics"/>
      <xs:element name="fontReference" type="FontReference"/>
    </xs:choice>
  </xs:group>

  <!-- Class TextFlags -->
  <xs:complexType name="TextFlags">
    <xs:sequence>
      <xs:element name="flag" type="TextFlag" minOccurs="1" maxOccurs="unbounded"/>
    </xs:sequence>
  </xs:complexType>

  <!-- Class TextElement -->
  <xs:complexType name="TextElement">
    <xs:sequence>
      <xs:element name="text" type="xs:string"/>
      <xs:element name="bodySize" type="xs:double"/>
      <xs:element name="flags" type="TextFlags" minOccurs="0" maxOccurs="1"/>
      <xs:element name="foreground" type="Color"/>
      <xs:element name="background" type="Color" minOccurs="0" maxOccurs="1"/>
      <xs:group ref="Font"/>
    </xs:sequence>
  </xs:complexType>

```

```

    </xs:sequence>
    <xs:attribute name="verticalOffset" type="xs:double" default="0.0"/>
  </xs:complexType>

  <!-- Class Text -->
  <xs:complexType name="Text" abstract="true">
    <xs:sequence>
      <xs:element name="element" type="TextElement" minOccurs="1" maxOccurs="unbounded"/>
    </xs:sequence>
    <xs:attribute name="horizontalAlignment" type="HorizontalAlignment" default="Start"/>
    <xs:attribute name="verticalAlignment" type="VerticalAlignment" default="Bottom"/>
  </xs:complexType>

  <!-- Class TextPoint -->
  <xs:complexType name="TextPoint">
    <xs:complexContent>
      <xs:extension base="Text">
        <xs:sequence>
          <xs:element name="offset" type="Vector" minOccurs="0" maxOccurs="1"/>
          <xs:element name="areaPlacement" type="AreaSymbolPlacement" minOccurs="0"
maxOccurs="1"/>
        </xs:sequence>
        <xs:attribute name="rotation" type="xs:double" default="0.0"/>
      </xs:extension>
    </xs:complexContent>
  </xs:complexType>

  <!-- Class TextLine -->
  <xs:complexType name="TextLine">
    <xs:complexContent>
      <xs:extension base="Text">
        <xs:sequence>
          <xs:element name="startOffset" type="xs:double"/>
          <xs:element name="endOffset" type="xs:double" minOccurs="0" maxOccurs="1"/>
          <xs:element name="placementMode" type="LinePlacementMode"/>
        </xs:sequence>
      </xs:extension>
    </xs:complexContent>
  </xs:complexType>

  <!-- Group Text -->
  <xs:group name="Text">
    <xs:choice>
      <xs:element name="textPoint" type="TextPoint"/>
      <xs:element name="textLine" type="TextLine"/>
    </xs:choice>
  </xs:group>

  <!-- THE COVERAGE PACKAGE -->
  <!-- Enumeration ChampionChoice -->
  <xs:simpleType name="ChampionChoice">
    <xs:restriction base="xs:string">
      <xs:enumeration value="Smallest"/>
      <xs:enumeration value="Largest"/>
    </xs:restriction>
  </xs:simpleType>

  <!-- Class CoverageColor -->
  <xs:complexType name="CoverageColor">

```

```

    <xs:sequence>
      <xs:element name="startColor" type="Color" />
      <xs:element name="endColor" type="Color" minOccurs="0" maxOccurs="1"/>
    </xs:sequence>
    <xs:attribute name="penWidth" type="xs:double" />
  </xs:complexType>

  <!-- Class NumericAnnotation -->
  <xs:complexType name="NumericAnnotation">
    <xs:sequence>
      <xs:group ref="Font"/>
      <xs:element name="color" type="Color" />
    </xs:sequence>
    <xs:attribute name="decimals" type="xs:int" default="1"/>
    <xs:attribute name="bodySize" type="xs:double" use="required"/>
    <xs:attribute name="buffer" type="xs:double" default="0"/>
    <xs:attribute name="champion" type="ChampionChoice" default="Smallest"/>
  </xs:complexType>

  <!-- Class SymbolAnnotation -->
  <xs:complexType name="SymbolAnnotation">
    <xs:sequence>
      <xs:element name="rotationAttribute" type="xs:string" minOccurs="0" maxOccurs="1" />
      <xs:element name="rotationFactor" type="xs:double" minOccurs="0" maxOccurs="1"/>
      <xs:element name="scaleAttribute" type="xs:string" minOccurs="0" maxOccurs="1" />
      <xs:element name="scaleFactor" type="xs:double" minOccurs="0" maxOccurs="1"/>
    </xs:sequence>
    <xs:attribute name="reference" type="IdString" use="required"/>
    <xs:attribute name="defaultRotation" type="xs:double" default="0.0"/>
    <xs:attribute name="rotationCRS" type="CRSType" default="PortrayalCRS"/>
    <xs:attribute name="defaultScaleFactor" type="xs:double" default="1.0"/>
  </xs:complexType>

  <!-- Class LookupEntry -->
  <xs:complexType name="LookupEntry">
    <xs:sequence>
      <xs:element name="label" type="xs:string"/>
      <xs:element name="range" type="s100CSL:S100_NumericRange" minOccurs="0"
maxOccurs="1"/>
      <xs:element name="color" type="CoverageColor" minOccurs="0" maxOccurs="1"/>
      <xs:element name="digits" type="NumericAnnotation" minOccurs="0" maxOccurs="1"/>
      <xs:element name="symbol" type="SymbolAnnotation" minOccurs="0" maxOccurs="1"/>
    </xs:sequence>
  </xs:complexType>

  <!-- Class CoverageFill -->
  <xs:complexType name="CoverageFill">
    <xs:sequence>
      <xs:element name="attributeCode" type="xs:string"/>
      <xs:element name="uom" type="s100CSL:S100_UnitOfMeasure" minOccurs="0"
maxOccurs="1"/>
      <xs:element name="lookup" type="LookupEntry" minOccurs="1" maxOccurs="unbounded"/>
    </xs:sequence>
  </xs:complexType>
</xs:schema>

```

### 9-A-2-1. S-100 Conceptual Schema Language Schema

```

<?xml version="1.0" encoding="UTF-8"?>
<xs:schema xmlns:xs="http://www.w3.org/2001/XMLSchema"
  xmlns="http://www.iho.int/S100ConceptualSchema"
  targetNamespace="http://www.iho.int/S100ConceptualSchema">
  <!-- S100 Conceptual Schema Language types -->
  <xs:simpleType name="maxOccurs">
    <xs:union>
      <xs:simpleType>
        <xs:restriction base='xs:nonNegativeInteger'/>
      </xs:simpleType>
      <xs:simpleType>
        <xs:restriction base='xs:string'>
          <xs:enumeration value='unbounded'/>
        </xs:restriction>
      </xs:simpleType>
    </xs:union>
  </xs:simpleType>
  <!-- UnlimitedInteger -->
  <xs:simpleType name="UnlimitedInteger">
    <xs:union>
      <xs:simpleType>
        <xs:restriction base='xs:integer'/>
      </xs:simpleType>
      <xs:simpleType>
        <xs:restriction base='xs:string'>
          <xs:enumeration value='Infinite'/>
        </xs:restriction>
      </xs:simpleType>
    </xs:union>
  </xs:simpleType>

  <!-- Enumeration S100_IntervalType -->
  <xs:simpleType name="S100_IntervalType">
    <xs:restriction base="xs:string">
      <xs:enumeration value="openInterval"/>
      <xs:enumeration value="geLtInterval"/>
      <xs:enumeration value="gtLeInterval"/>
      <xs:enumeration value="closedInterval"/>
      <xs:enumeration value="gtSemilInterval"/>
      <xs:enumeration value="geSemilInterval"/>
      <xs:enumeration value="ltSemilInterval"/>
      <xs:enumeration value="leSemilInterval"/>
    </xs:restriction>
  </xs:simpleType>

  <!-- Enumeration S100_NumericRange -->
  <xs:complexType name="S100_NumericRange">
    <xs:attribute name="lower" type="xs:double" />
    <xs:attribute name="upper" type="xs:double" />
    <xs:attribute name="closure" type="S100_IntervalType" />
  </xs:complexType>

  <!-- Enumeration S100_UnitOfMeasure -->
  <xs:complexType name="S100_UnitOfMeasure">
    <xs:attribute name="name" type="xs:string" use="required"/>
    <xs:attribute name="definition" type="xs:string" />
    <xs:attribute name="symbol" type="xs:string" />
  </xs:complexType>

```



```
</xs:schema>
```

### 9-A-3. Presentation Schema

```
<?xml version="1.0" encoding="UTF-8"?>
<xs:schema xmlns="http://www.iho.int/S100Presentation"
  xmlns:xs="http://www.w3.org/2001/XMLSchema"
  xmlns:s100Symbol="http://www.iho.int/S100SymbolDefinition"
  targetNamespace="http://www.iho.int/S100Presentation" attributeFormDefault="qualified">
  <xs:import namespace="http://www.iho.int/S100SymbolDefinition"
    schemaLocation="S100SymbolDefinition.xsd"/>
  <!-- Simple non empty alpha numeric string type for references -->
  <xs:simpleType name="Reference">
    <xs:restriction base="xs:string">
      <xs:minLength value="1"/>
      <xs:pattern value="[0-9a-zA-Z_]*"/>
    </xs:restriction>
  </xs:simpleType>

  <!-- Class Spatial Reference -->
  <xs:complexType name="SpatialReference">
    <xs:simpleContent>
      <xs:extension base="Reference">
        <xs:attribute name="forward" type="xs:boolean" default="true"/>
      </xs:extension>
    </xs:simpleContent>
  </xs:complexType>

  <!-- Class DrawingInstruction -->
  <xs:complexType name="DrawingInstruction" abstract="true">
    <xs:sequence>
      <xs:element name="featureReference" type="Reference"/>
      <xs:element name="spatialReference" type="SpatialReference" minOccurs="0"
maxOccurs="unbounded"/>
      <xs:element name="viewingGroup" type="xs:string"/>
      <xs:element name="displayPlane" type="xs:string"/>
      <xs:element name="drawingPriority" type="xs:int"/>
      <xs:element name="scaleMinimum" type="xs:positiveInteger" minOccurs="0" maxOccurs="1"/>
      <xs:element name="scaleMaximum" type="xs:positiveInteger" minOccurs="0" maxOccurs="1"/>
    </xs:sequence>
  </xs:complexType>

  <!-- Class NullInstruction -->
  <xs:complexType name="NullInstruction">
    <xs:complexContent>
      <xs:extension base="DrawingInstruction"/>
    </xs:complexContent>
  </xs:complexType>

  <!-- Class pointInstruction -->
  <xs:complexType name="PointInstruction">
    <xs:complexContent>
      <xs:extension base="DrawingInstruction">
        <xs:sequence>
          <xs:element name="symbol" type="s100Symbol:Symbol"/>
        </xs:sequence>
      </xs:extension>
    </xs:complexContent>
  </xs:complexType>
```

```

<!-- Class Area Instruction -->
<xs:complexType name="AreaInstruction">
  <xs:complexContent>
    <xs:extension base="DrawingInstruction">
      <xs:sequence>
        <xs:group ref="s100Symbol:AreaFillGroup"/>
      </xs:sequence>
    </xs:extension>
  </xs:complexContent>
</xs:complexType>

<!-- Class LineInstruction -->
<xs:complexType name="LineInstruction">
  <xs:complexContent>
    <xs:extension base="DrawingInstruction">
      <xs:sequence>
        <xs:group ref="s100Symbol:LineStyleGroup"/>
      </xs:sequence>
      <xs:attribute name="suppression" type="xs:boolean" default="true"/>
    </xs:extension>
  </xs:complexContent>
</xs:complexType>

<!-- Class TextInstruction -->
<xs:complexType name="TextInstruction">
  <xs:complexContent>
    <xs:extension base="DrawingInstruction">
      <xs:sequence>
        <xs:group ref="s100Symbol:Text"/>
      </xs:sequence>
    </xs:extension>
  </xs:complexContent>
</xs:complexType>

<!-- Class CoverageInstruction -->
<xs:complexType name="CoverageInstruction">
  <xs:complexContent>
    <xs:extension base="DrawingInstruction">
      <xs:sequence>
        <xs:element name="coverageFill" type="s100Symbol:CoverageFill"/>
      </xs:sequence>
    </xs:extension>
  </xs:complexContent>
</xs:complexType>

<!-- Class AugmentedGeometry -->
<xs:complexType name="AugmentedGeometry" abstract="true">
  <xs:complexContent>
    <xs:extension base="DrawingInstruction">
      <xs:sequence>
        <xs:element name="crs" type="s100Symbol:CRSType"/>
        <xs:group ref="s100Symbol:Text" minOccurs="0" maxOccurs="1"/>
      </xs:sequence>
    </xs:extension>
  </xs:complexContent>
</xs:complexType>

<!-- Class AugmentedPoint -->
<xs:complexType name="AugmentedPoint">

```

```

    <xs:complexContent>
      <xs:extension base="AugmentedGeometry">
        <xs:sequence>
          <xs:element name="position" type="s100Symbol:Point"/>
          <xs:element name="symbol" type="s100Symbol:Symbol" minOccurs="0"
maxOccurs="1"/>
        </xs:sequence>
      </xs:extension>
    </xs:complexContent>
  </xs:complexType>

<!-- Class AugmentedLineOrArea -->
<xs:complexType name="AugmentedLineOrArea" abstract="true">
  <xs:complexContent>
    <xs:extension base="AugmentedGeometry">
      <xs:sequence>
        <xs:group ref="s100Symbol:LineStyleGroup" minOccurs="0" maxOccurs="1"/>
      </xs:sequence>
    </xs:extension>
  </xs:complexContent>
</xs:complexType>

<!-- Class AugmentedRay -->
<xs:complexType name="AugmentedRay">
  <xs:complexContent>
    <xs:extension base="AugmentedLineOrArea">
      <xs:sequence>
        <xs:element name="direction" type="xs:double"/>
        <xs:element name="length" type="xs:double"/>
      </xs:sequence>
    </xs:extension>
  </xs:complexContent>
</xs:complexType>

<!-- Class AugmentedPath -->
<xs:complexType name="AugmentedPath">
  <xs:complexContent>
    <xs:extension base="AugmentedLineOrArea">
      <xs:sequence>
        <xs:element name="path" type="s100Symbol:Path"/>
      </xs:sequence>
    </xs:extension>
  </xs:complexContent>
</xs:complexType>

<!-- Class AugmentedArea -->
<xs:complexType name="AugmentedArea">
  <xs:complexContent>
    <xs:extension base="AugmentedPath">
      <xs:sequence>
        <xs:group ref="s100Symbol:AreaFillGroup" minOccurs="0" maxOccurs="1"/>
      </xs:sequence>
    </xs:extension>
  </xs:complexContent>
</xs:complexType>

<!-- Group DisplayInstruction -->
<xs:group name="DisplayInstruction">
  <xs:choice>
    <xs:element name="nullInstruction" type="NullInstruction"/>
  </xs:choice>
</xs:group>

```

```

    <xs:element name="pointInstruction" type="PointInstruction"/>
    <xs:element name="lineInstruction" type="LineInstruction"/>
    <xs:element name="areaInstruction" type="AreaInstruction"/>
    <xs:element name="coverageInstruction" type="CoverageInstruction"/>
    <xs:element name="textInstruction" type="TextInstruction"/>
    <xs:element name="augmentedPoint" type="AugmentedPoint"/>
    <xs:element name="augmentedRay" type="AugmentedRay"/>
    <xs:element name="augmentedPath" type="AugmentedPath"/>
    <xs:element name="augmentedArea" type="AugmentedArea"/>
  </xs:choice>
</xs:group>

<!-- Class DisplayList -->
<xs:complexType name="DisplayList">
  <xs:sequence>
    <xs:group ref="DisplayInstruction" minOccurs="0" maxOccurs="unbounded"/>
  </xs:sequence>
</xs:complexType>

<!-- An element of type DisplayList -->
<xs:element name="displayList" type="DisplayList"/>
</xs:schema>

```

#### 9-A-4. Example Result Display List

```

<?xml version="1.0" encoding="UTF-8"?>
<displayList xmlns:xsi="http://www.w3.org/2001/XMLSchema-instance"
  xsi:noNamespaceSchemaLocation="S100Presentation.xsd">
  <areaInstruction>
    <featureReference reference="1"/>
    <viewingGroup>13030</viewingGroup>
    <displayPlane>S</displayPlane>
    <drawingPriority>10</drawingPriority>
    <colorFill>
      <color>
        <token>DEPIT</token>
        <transparency/>
      </color>
    </colorFill>
  </areaInstruction>
  <areaInstruction>
    <featureReference reference="1"/>
    <viewingGroup>13030</viewingGroup>
    <displayPlane>S</displayPlane>
    <drawingPriority>11</drawingPriority>
    <pixmapFill>
      <areaCRS>Global</areaCRS>
      <pixmap>
        <symbolReference>DIAMOND01</symbolReference>
      </pixmap>
    </pixmapFill>
  </areaInstruction>
  <pointInstruction>
    <featureReference reference="2"/>
    <viewingGroup>17020</viewingGroup>
    <displayPlane>O</displayPlane>
    <drawingPriority>80</drawingPriority>
    <symbol>
      <symbolReference>BCNCAR03</symbolReference>
    </symbol>
  </pointInstruction>

```

```

        <rotation/>
        <rotationCRS/>
        <scaleFactor/>
    </symbol>
</pointInstruction>

<areaInstruction>
    <featureReference reference="3"/>
    <viewingGroup>13030</viewingGroup>
    <displayPlane>S</displayPlane>
    <drawingPriority>10</drawingPriority>
    <colorFill>
        <color>
            <token>DEPVS</token>
            <transparency/>
        </color>
    </colorFill>
</areaInstruction>
<areaInstruction>
    <featureReference reference="3"/>
    <viewingGroup>13030</viewingGroup>
    <displayPlane>S</displayPlane>
    <drawingPriority>11</drawingPriority>
    <pixmapFill>
        <areaCRS>Global</areaCRS>
        <pixmap>
            <symbolReference>DIAMOND01</symbolReference>
        </pixmap>
    </pixmapFill>
</areaInstruction>

<lineInstruction>
    <featureReference reference="4"/>
    <spatialReference reference="2" forward="true"/>
    <viewingGroup>33020</viewingGroup>
    <displayPlane>O</displayPlane>
    <drawingPriority>50</drawingPriority>
    <simpleLineStyle>
        <capStyle/>
        <joinStyle/>
        <offset/>
        <pen width="1">
            <color>
                <token>DEPCN</token>
                <transparency/>
            </color>
        </pen>
    </simpleLineStyle>
</lineInstruction>
<lineInstruction>
    <featureReference reference=""/>
    <spatialReference reference="1" forward="true"/>
    <viewingGroup>33020</viewingGroup>
    <displayPlane>O</displayPlane>
    <drawingPriority>50</drawingPriority>
    <simpleLineStyle>
        <capStyle/>
        <joinStyle/>
        <offset/>
        <pen width="1">

```

```

        <color>
            <token>DEPCN</token>
            <transparency/>
        </color>
    </pen>
</simpleLineStyle>
</lineInstruction>
<lineInstruction>
    <featureReference reference=""/>
    <spatialReference reference="5" forward="false"/>
    <viewingGroup>33020</viewingGroup>
    <displayPlane>O</displayPlane>
    <drawingPriority>50</drawingPriority>
    <simpleLineStyle>
        <capStyle/>
        <joinStyle/>
        <offset/>
        <pen width="1">
            <color>
                <token>DEPCN</token>
                <transparency/>
            </color>
        </pen>
    </simpleLineStyle>
</lineInstruction>
<lineInstruction>
    <featureReference reference=""/>
    <spatialReference reference="3" forward="false"/>
    <viewingGroup>33020</viewingGroup>
    <displayPlane>O</displayPlane>
    <drawingPriority>50</drawingPriority>
    <simpleLineStyle>
        <capStyle/>
        <joinStyle/>
        <intervalLength>4</intervalLength>
        <offset/>
        <pen width="1">
            <color>
                <token>DEPCN</token>
                <transparency/>
            </color>
        </pen>
        <dash>
            <start>0.0</start>
            <length>2.0</length>
        </dash>
    </simpleLineStyle>
</lineInstruction>

<lineInstruction>
    <featureReference reference="5"/>
    <spatialReference reference="2" forward="true"/>
    <viewingGroup>33020</viewingGroup>
    <displayPlane>O</displayPlane>
    <drawingPriority>50</drawingPriority>
    <simpleLineStyle>
        <capStyle/>
        <joinStyle/>
        <offset/>
        <pen width="1">

```

```

        <color>
            <token>DEPCN</token>
            <transparency/>
        </color>
    </pen>
</simpleLineStyle>
</lineInstruction>
<lineInstruction>
    <featureReference reference="5"/>
    <spatialReference reference="3" forward="false"/>
    <viewingGroup>33020</viewingGroup>
    <displayPlane>O</displayPlane>
    <drawingPriority>50</drawingPriority>
    <simpleLineStyle>
        <capStyle/>
        <joinStyle/>
        <intervalLength>4</intervalLength>
        <offset/>
        <pen width="1">
            <color>
                <token>DEPCN</token>
                <transparency/>
            </color>
        </pen>
        <dash>
            <start>0.0</start>
            <length>2.0</length>
        </dash>
    </simpleLineStyle>
</lineInstruction>

<pointInstruction>
    <featureReference reference="6"/>
    <viewingGroup>22220</viewingGroup>
    <displayPlane>O</displayPlane>
    <drawingPriority>60</drawingPriority>
    <symbol>
        <symbolReference>BUIREL13</symbolReference>
        <rotation/>
        <rotationCRS/>
        <scaleFactor/>
    </symbol>
</pointInstruction>

<arealInstruction>
    <featureReference reference="7"/>
    <viewingGroup>13030</viewingGroup>
    <displayPlane>S</displayPlane>
    <drawingPriority>10</drawingPriority>
    <colorFill>
        <color>
            <token>DEPMS</token>
            <transparency/>
        </color>
    </colorFill>
</arealInstruction>
<arealInstruction>
    <featureReference reference="7"/>
    <viewingGroup>13030</viewingGroup>
    <displayPlane>S</displayPlane>

```

```

    <drawingPriority>11</drawingPriority>
    <pixmapFill>
      <areaCRS>Global</areaCRS>
      <pixmap>
        <symbolReference>DIAMOND01</symbolReference>
      </pixmap>
    </pixmapFill>
  </areaInstruction>

<areaInstruction>
  <featureReference reference="8"/>
  <viewingGroup>13030</viewingGroup>
  <displayPlane>S</displayPlane>
  <drawingPriority>10</drawingPriority>
  <colorFill>
    <color>
      <token>DEPMD</token>
      <transparency/>
    </color>
  </colorFill>
</areaInstruction>

<areaInstruction>
  <featureReference reference="9"/>
  <viewingGroup>13030</viewingGroup>
  <displayPlane>S</displayPlane>
  <drawingPriority>10</drawingPriority>
  <colorFill>
    <color>
      <token>DEPDW</token>
      <transparency/>
    </color>
  </colorFill>
</areaInstruction>

<pointInstruction>
  <featureReference reference="10"/>
  <viewingGroup>32220</viewingGroup>
  <displayPlane>O</displayPlane>
  <drawingPriority>40</drawingPriority>
  <symbol>
    <symbolReference>FLGSTF01</symbolReference>
    <rotation/>
    <rotationCRS/>
    <scaleFactor/>
  </symbol>
</pointInstruction>

<pointInstruction>
  <featureReference reference="11"/>
  <viewingGroup>32220</viewingGroup>
  <displayPlane>O</displayPlane>
  <drawingPriority>40</drawingPriority>
  <symbol>
    <symbolReference>POSGEN01</symbolReference>
    <rotation/>
    <rotationCRS/>
    <scaleFactor/>
  </symbol>
</pointInstruction>

```



```

<pointInstruction>
  <featureReference reference="12"/>
  <viewingGroup>32220</viewingGroup>
  <displayPlane>O</displayPlane>
  <drawingPriority>40</drawingPriority>
  <symbol>
    <symbolReference>TOWERS01</symbolReference>
    <rotation/>
    <rotationCRS/>
    <scaleFactor/>
  </symbol>
</pointInstruction>
<textInstruction>
  <featureReference reference="12"/>
  <viewingGroup>32220</viewingGroup>
  <displayPlane>O</displayPlane>
  <drawingPriority>40</drawingPriority>
  <textPoint>
    <element>
      <text>A name</text>
      <bodySize>12</bodySize>
      <verticalOffset/>
      <foreground>
        <token>CHBLK</token>
        <transparency/>
      </foreground>
      <font>
        <serifs>true</serifs>
        <weight>Bold</weight>
        <slant>Upright</slant>
        <proportion>Proportional</proportion>
      </font>
    </element>
    <rotation/>
  </textPoint>
</textInstruction>

<pointInstruction>
  <featureReference reference="13"/>
  <viewingGroup>22220</viewingGroup>
  <displayPlane>O</displayPlane>
  <drawingPriority>60</drawingPriority>
  <symbol>
    <symbolReference>POSGEN03</symbolReference>
    <rotation/>
    <rotationCRS/>
    <scaleFactor/>
  </symbol>
</pointInstruction>
</displayList>

```

## 9-A-5. Portrayal Catalogue Schema

```

<?xml version="1.0" encoding="UTF-8"?>
<xs:schema xmlns:xs="http://www.w3.org/2001/XMLSchema"
  xmlns:s100Symbol="http://www.iho.int/S100SymbolDefinition">
  <xs:import namespace="http://www.iho.int/S100SymbolDefinition"
    schemaLocation="S100SymbolDefinition.xsd"/>
  <!-- Supported type for context parameters -->
  <xs:simpleType name="ParameterType">
    <xs:restriction base="xs:string">
      <xs:enumeration value="Boolean"/>
      <xs:enumeration value="Integer"/>
      <xs:enumeration value="Double"/>
      <xs:enumeration value="String"/>
      <xs:enumeration value="Date"/>
    </xs:restriction>
  </xs:simpleType>

  <!-- The type of an external file -->
  <xs:simpleType name="FileType">
    <xs:restriction base="xs:string">
      <xs:enumeration value="Font"/>
      <xs:enumeration value="AreaFill"/>
      <xs:enumeration value="LineStyle"/>
      <xs:enumeration value="Symbol"/>
      <xs:enumeration value="ColorProfile"/>
      <xs:enumeration value="Pixmap"/>
      <xs:enumeration value="Rule"/>
    </xs:restriction>
  </xs:simpleType>

  <!-- The format of an external file -->
  <xs:simpleType name="FileFormat">
    <xs:restriction base="xs:string">
      <xs:enumeration value="XML"/>
      <xs:enumeration value="SVG"/>
      <xs:enumeration value="XSLT"/>
      <xs:enumeration value="TTF"/>
    </xs:restriction>
  </xs:simpleType>

  <!-- The type of an template -->
  <xs:simpleType name="RuleType">
    <xs:restriction base="xs:string">
      <xs:enumeration value="TopLevelTemplate"/>
      <xs:enumeration value="SubTemplate"/>
    </xs:restriction>
  </xs:simpleType>

  <!-- Class for descriptive information about a catalogue item -->
  <xs:complexType name="Description">
    <xs:sequence>
      <xs:element name="name" type="xs:string" minOccurs="0" maxOccurs="1"/>
      <xs:element name="description" type="xs:string"/>
      <xs:element name="language" type="xs:language"/>
    </xs:sequence>
  </xs:complexType>

  <!-- Abstract base class for catalogue items -->

```

```

<xs:complexType name="CatalogItem" abstract="true">
  <xs:sequence>
    <xs:element name="description" type="Description" minOccurs="0" maxOccurs="unbounded"/>
  </xs:sequence>
  <xs:attribute name="id" type="s100Symbol:IdString" use="required"/>
</xs:complexType>

<!-- catalogue item for an external file -->
<xs:complexType name="ExternalFile">
  <xs:complexContent>
    <xs:extension base="CatalogItem">
      <xs:sequence>
        <xs:element name="fileName" type="xs:anyURI"/>
        <xs:element name="fileType" type="FileType"/>
        <xs:element name="fileFormat" type="FileFormat"/>
      </xs:sequence>
    </xs:extension>
  </xs:complexContent>
</xs:complexType>

<!-- catalogue item for an XSLT rule file -->
<xs:complexType name="RuleFile">
  <xs:complexContent>
    <xs:extension base="ExternalFile">
      <xs:sequence>
        <xs:element name="ruleType" type="RuleType"/>
      </xs:sequence>
    </xs:extension>
  </xs:complexContent>
</xs:complexType>

<!-- Class for a viewing group -->
<xs:complexType name="ViewingGroup">
  <xs:complexContent>
    <xs:extension base="CatalogItem"/>
  </xs:complexContent>
</xs:complexType>

<!-- Class for a viewing group layer (an aggregation of viewing groups) -->
<xs:complexType name="ViewingGroupLayer">
  <xs:complexContent>
    <xs:extension base="CatalogItem">
      <xs:sequence>
        <xs:element name="viewingGroup" type="s100Symbol:IdString" minOccurs="1"
maxOccurs="unbounded"/>
      </xs:sequence>
    </xs:extension>
  </xs:complexContent>
</xs:complexType>

<!-- Class for a display mode (an aggregation of viewing group layers) -->
<xs:complexType name="DisplayMode">
  <xs:complexContent>
    <xs:extension base="CatalogItem">
      <xs:sequence>
        <xs:element name="viewingGroupLayer" type="s100Symbol:IdString" minOccurs="1"
maxOccurs="unbounded"/>
      </xs:sequence>
    </xs:extension>
  </xs:complexContent>
</xs:complexType>

```

```

    </xs:complexContent>
  </xs:complexType>

  <!-- Class for a display plane -->
  <xs:complexType name="DisplayPlane">
    <complexContent>
      <xs:extension base="CatalogItem"/>
    </complexContent>
  </xs:complexType>

  <!-- Class for a context parameter -->
  <xs:complexType name="ContextParameter">
    <complexContent>
      <xs:extension base="CatalogItem">
        <xs:sequence>
          <xs:element name="type" type="ParameterType"/>
          <xs:element name="default" type="xs:anyType"/>
        </xs:sequence>
      </xs:extension>
    </complexContent>
  </xs:complexType>

  <xs:complexType name="Pixmap">
    <xs:sequence>
      <xs:element name="pixmap" type="ExternalFile" minOccurs="0" maxOccurs="unbounded"/>
    </xs:sequence>
  </xs:complexType>

  <xs:complexType name="ColorProfiles">
    <xs:sequence>
      <xs:element name="colorProfile" type="ExternalFile" minOccurs="0"
maxOccurs="unbounded"/>
    </xs:sequence>
  </xs:complexType>

  <xs:complexType name="Symbols">
    <xs:sequence>
      <xs:element name="symbol" type="ExternalFile" minOccurs="0" maxOccurs="unbounded"/>
    </xs:sequence>
  </xs:complexType>

  <xs:complexType name="LineStyle">
    <xs:sequence>
      <xs:element name="lineStyle" type="ExternalFile" minOccurs="0" maxOccurs="unbounded"/>
    </xs:sequence>
  </xs:complexType>

  <xs:complexType name="AreaFills">
    <xs:sequence>
      <xs:element name="areaFill" type="ExternalFile" minOccurs="0" maxOccurs="unbounded"/>
    </xs:sequence>
  </xs:complexType>

  <xs:complexType name="Fonts">
    <xs:sequence>
      <xs:element name="font" type="ExternalFile" minOccurs="0" maxOccurs="unbounded"/>
    </xs:sequence>
  </xs:complexType>

  <xs:complexType name="ViewingGroups">

```

```

    <xs:sequence>
      <xs:element name="viewingGroup" type="ViewingGroup" minOccurs="1"
maxOccurs="unbounded"/>
    </xs:sequence>
  </xs:complexType>

  <xs:complexType name="ViewingGroupLayers">
    <xs:sequence>
      <xs:element name="viewingGroupLayer" type="ViewingGroupLayer" minOccurs="0"
maxOccurs="unbounded"/>
    </xs:sequence>
  </xs:complexType>

  <xs:complexType name="DisplayModes">
    <xs:sequence>
      <xs:element name="displayMode" type="DisplayMode" minOccurs="0"
maxOccurs="unbounded"/>
    </xs:sequence>
  </xs:complexType>

  <xs:complexType name="DisplayPlanes">
    <xs:sequence>
      <xs:element name="displayPlane" type="DisplayPlane" minOccurs="1"
maxOccurs="unbounded"/>
    </xs:sequence>
  </xs:complexType>

  <xs:complexType name="Context">
    <xs:sequence>
      <xs:element name="parameter" type="ContextParameter" minOccurs="0"
maxOccurs="unbounded"/>
    </xs:sequence>
  </xs:complexType>

  <xs:complexType name="Rules">
    <xs:sequence>
      <xs:element name="ruleFile" type="RuleFile" minOccurs="1" maxOccurs="unbounded"/>
    </xs:sequence>
  </xs:complexType>

  <xs:complexType name="PortrayalCatalog">
    <xs:sequence>
      <xs:element name="pixmaps" type="Pixmaps">
        <xs:key name="pixmapKey">
          <xs:selector xpath="pixmap"/>
          <xs:field xpath="@id"/>
        </xs:key>
      </xs:element>
      <xs:element name="colorProfiles" type="ColorProfiles">
        <xs:key name="colorProfileKey">
          <xs:selector xpath="colorProfile"/>
          <xs:field xpath="@id"/>
        </xs:key>
      </xs:element>
      <xs:element name="symbols" type="Symbols">
        <xs:key name="symbolKey">
          <xs:selector xpath="symbol"/>
          <xs:field xpath="@id"/>
        </xs:key>
      </xs:element>
    </xs:sequence>
  </xs:complexType>

```

```

<xs:element name="lineStyles" type="LineStyles">
  <xs:key name="lineStyleKey">
    <xs:selector xpath="lineStyle"/>
    <xs:field xpath="@id"/>
  </xs:key>
</xs:element>
<xs:element name="areaFills" type="AreaFills">
  <xs:key name="areaFillKey">
    <xs:selector xpath="areaFill"/>
    <xs:field xpath="@id"/>
  </xs:key>
</xs:element>
<xs:element name="fonts" type="Fonts">
  <xs:key name="fontKey">
    <xs:selector xpath="font"/>
    <xs:field xpath="@id"/>
  </xs:key>
</xs:element>
<xs:element name="viewingGroups" type="ViewingGroups">
  <xs:key name="viewingGroupKey">
    <xs:selector xpath="viewingGroup"/>
    <xs:field xpath="@id"/>
  </xs:key>
</xs:element>
<xs:element name="foundationMode">
  <xs:complexType>
    <xs:sequence>
      <xs:element name="viewingGroup" type="s100Symbol:IdString" minOccurs="0"
maxOccurs="unbounded"/>
    </xs:sequence>
  </xs:complexType>
</xs:element>
<xs:element name="viewingGroupLayers" type="ViewingGroupLayers">
  <xs:key name="viewingGroupLayerKey">
    <xs:selector xpath="viewingGroupLayer"/>
    <xs:field xpath="@id"/>
  </xs:key>
</xs:element>
<xs:element name="displayModes" type="DisplayModes">
  <xs:key name="displayModeKey">
    <xs:selector xpath="displayMode"/>
    <xs:field xpath="@id"/>
  </xs:key>
</xs:element>
<xs:element name="displayPlane" type="DisplayPlanes">
  <xs:key name="displayPlaneKey">
    <xs:selector xpath="displayPlane"/>
    <xs:field xpath="@id"/>
  </xs:key>
</xs:element>
<xs:element name="context" type="Context">
  <xs:key name="contextKey">
    <xs:selector xpath="parameter"/>
    <xs:field xpath="@id"/>
  </xs:key>
</xs:element>
<xs:element name="rules" type="Rules">
  <xs:key name="ruleKey">
    <xs:selector xpath="ruleFile"/>
    <xs:field xpath="@id"/>
  </xs:key>

```

```

        </xs:key>
      </xs:element>
    </xs:sequence>
    <xs:attribute name="productId" type="xs:string" use="required"/>
    <xs:attribute name="version" type="xs:string" use="required"/>
  </xs:complexType>

  <!-- THE ROOT ELEMENT -->
  <xs:element name="portrayalCatalog" type="PortrayalCatalog">
    <!-- KEYREF FOR VIEWING GROUPS -->
    <xs:keyref name="viewingGroupRef" refer="viewingGroupKey">
      <xs:selector
xpath="viewingGroupLayers/viewingGroupLayer/viewingGroup|foundationMode/viewingGroup"/>
      <xs:field xpath="."/>
    </xs:keyref>
    <!-- KEYREF FOR VIEWING GROUP LAYERS -->
    <xs:keyref name="viewingGroupLayerRef" refer="viewingGroupLayerKey">
      <xs:selector xpath="displayModes/displayMode/viewingGroupLayer"/>
      <xs:field xpath="."/>
    </xs:keyref>
  </xs:element>
</xs:schema>

```

## 9-A-6. S-100 Color Profile

```

<?xml version="1.0" encoding="UTF-8"?>
<xs:schema xmlns:xs="http://www.w3.org/2001/XMLSchema">
  <xs:simpleType name="Token">
    <xs:restriction base="xs:string">
      <xs:minLength value="1"/>
      <xs:pattern value="[a-zA-Z][0-9a-zA-Z_]*"/>
    </xs:restriction>
  </xs:simpleType>

  <xs:simpleType name="ColorInteger">
    <xs:restriction base="xs:nonNegativeInteger">
      <xs:minInclusive value="0"/>
      <xs:maxInclusive value="255"/>
    </xs:restriction>
  </xs:simpleType>

  <xs:simpleType name="NormalDouble">
    <xs:restriction base="xs:double">
      <xs:minInclusive value="0.0"/>
      <xs:maxInclusive value="1.0"/>
    </xs:restriction>
  </xs:simpleType>

  <xs:complexType name="CIExyL">
    <xs:sequence>
      <xs:element name="x" type="NormalDouble"/>
      <xs:element name="y" type="NormalDouble"/>
      <xs:element name="L" type="xs:double"/>
    </xs:sequence>
  </xs:complexType>

  <xs:complexType name="CIEXYZ">
    <xs:sequence>
      <xs:element name="X" type="xs:double"/>
      <xs:element name="Y" type="xs:double"/>

```

```

    <xs:element name="Z" type="xs:double"/>
  </xs:sequence>
</xs:complexType>

<xs:complexType name="sRGB">
  <xs:sequence>
    <xs:element name="red" type="ColorInteger"/>
    <xs:element name="green" type="ColorInteger"/>
    <xs:element name="blue" type="ColorInteger"/>
  </xs:sequence>
</xs:complexType>

<xs:complexType name="CIE">
  <xs:choice>
    <xs:element name="xyL" type="CIExyL"/>
    <xs:element name="XYZ" type="CIEXYZ"/>
  </xs:choice>
</xs:complexType>

<xs:complexType name="ColorName">
  <xs:sequence>
    <xs:element name="description" type="xs:string" minOccurs="0" maxOccurs="1"/>
  </xs:sequence>
  <xs:attribute name="name" type="xs:string"/>
  <xs:attribute name="token" type="Token" use="required"/>
</xs:complexType>

<xs:complexType name="Colors">
  <xs:sequence>
    <xs:element name="color" type="ColorName" minOccurs="1" maxOccurs="unbounded"/>
  </xs:sequence>
</xs:complexType>

<xs:complexType name="PalettelItem">
  <xs:sequence>
    <xs:element name="cie" type="CIE"/>
    <xs:element name="srgb" type="SRGB"/>
  </xs:sequence>
  <xs:attribute name="token" type="Token" use="required"/>
</xs:complexType>

<xs:complexType name="Palette">
  <xs:sequence>
    <xs:element name="item" type="PalettelItem" minOccurs="1" maxOccurs="unbounded"/>
  </xs:sequence>
  <xs:attribute name="name" type="xs:string" use="required"/>
</xs:complexType>

<xs:complexType name="ColorProfile">
  <xs:sequence>
    <xs:element name="colors" type="Colors">
      <xs:key name="colorKey">
        <xs:selector xpath="color"/>
        <xs:field xpath="@token"/>
      </xs:key>
    </xs:element>
    <xs:element name="palette" type="Palette" minOccurs="1" maxOccurs="unbounded">
      <xs:unique name="tokenUnique">
        <xs:selector xpath="item"/>
        <xs:field xpath="@token"/>
      </xs:unique>
    </xs:element>
  </xs:sequence>

```



```

        </xs:unique>
      </xs:element>
    </xs:sequence>
  </xs:complexType>

  <xs:element name="colorProfile" type="ColorProfile">
    <xs:keyref name="colorRef" refer="colorKey">
      <xs:selector xpath="palette/item"/>
      <xs:field xpath="@token"/>
    </xs:keyref>
  </xs:element>
</xs:schema>

```

### 9-A-7. Sample Colour Profile

```

<?xml version="1.0" encoding="UTF-8"?>
<colorProfile xmlns:xsi="http://www.w3.org/2001/XMLSchema-instance"
xsi:noNamespaceSchemaLocation="s100ColorProfile.xsd">
  <colors>
    <color token="NODTA" name="grey">
      <description>No data color</description>
    </color>
    <color token="CURSR" name="orange"/>
  </colors>

  <palette name="Day">
    <item token="NODTA">
      <cie>
        <xyL>
          <x>0.280</x>
          <y>0.310</y>
          <L>45.0</L>
        </xyL>
      </cie>
      <srgb>
        <red>171</red>
        <green>192</green>
        <blue>177</blue>
      </srgb>
    </item>
    <item token="CURSR">
      <cie>
        <xyL>
          <x>0.52</x>
          <y>0.39</y>
          <L>28.0</L>
        </xyL>
      </cie>
      <srgb>
        <red>230</red>
        <green>121</green>
        <blue>56</blue>
      </srgb>
    </item>
  </palette>

  <palette name="Dusk">
    <item token="NODTA">
      <cie>

```

```

    <xyL>
      <x>0.28</x>
      <y>0.31</y>
      <L>25.0</L>
    </xyL>
  </cie>
  <srgb>
    <red>136</red>
    <green>152</green>
    <blue>139</blue>
  </srgb>
</item>
<item token="CURSR">
  <cie>
    <xyL>
      <x>0.52</x>
      <y>0.39</y>
      <L>28.0</L>
    </xyL>
  </cie>
  <srgb>
    <red>230</red>
    <green>121</green>
    <blue>56</blue>
  </srgb>
</item>
</palette>

<palette name="Night">
  <item token="NODTA">
    <cie>
      <xyL>
        <x>0.28</x>
        <y>0.31</y>
        <L>2.25</L>
      </xyL>
    </cie>
    <srgb>
      <red>56</red>
      <green>61</green>
      <blue>55</blue>
    </srgb>
  </item>
  <item token="CURSR">
    <cie>
      <xyL>
        <x>0.52</x>
        <y>0.39</y>
        <L>2.52</L>
      </xyL>
    </cie>
    <srgb>
      <red>89</red>
      <green>50</green>
      <blue>22</blue>
    </srgb>
  </item>
</palette>

</colorProfile>

```

### 9-A-7.1. S-100 Line Style

```
<?xml version="1.0" encoding="UTF-8"?>
<xs:schema xmlns:xs="http://www.w3.org/2001/XMLSchema"
  xmlns:s100Symbol="http://www.iho.int/S100SymbolDefinition">
  <xs:import namespace="http://www.iho.int/S100SymbolDefinition"
    schemaLocation="S100SymbolDefinition.xsd"/>

  <xs:element name="lineStyleBase" type="s100Symbol:LineStyleBase"/>

  <xs:element name="LineStyle" type="s100Symbol:LineStyle" substitutionGroup="LineStyleBase"/>

  <xs:element name="compositeLineStyle" type="s100Symbol:CompositeLineStyle"
    substitutionGroup="LineStyleBase"/>
</xs:schema>
```

#### 9-A-7.1.1. Sample Line Style

```
<?xml version="1.0" encoding="UTF-8"?>
<lineStyle xmlns:xsi="http://www.w3.org/2001/XMLSchema-instance"
  xsi:noNamespaceSchemaLocation="s100LineStyle.xsd">
  <intervalLength>6</intervalLength>
  <pen width="0.3">
    <color>#aabbcc</color>
  </pen>
  <dash>
    <start>0</start>
    <length>1</length>
  </dash>
  <dash>
    <start>2</start>
    <length>3</length>
  </dash>
  <symbol reference="bla">
    <position>3.5</position>
  </symbol>
</lineStyle>
```

#### 9-A-7.1.2. S-100 Area Fill

```
<?xml version="1.0" encoding="UTF-8"?>
<xs:schema xmlns:xs="http://www.w3.org/2001/XMLSchema"
  xmlns:s100Symbol="http://www.iho.int/S100SymbolDefinition">
  <xs:import namespace="http://www.iho.int/S100SymbolDefinition"
    schemaLocation="S100SymbolDefinition.xsd"/>

  <xs:element name="areaFillBase" type="s100Symbol:AreaFillBase"/>

  <xs:element name="colorFill" type="s100Symbol:ColorFill" substitutionGroup="areaFillBase"/>

  <xs:element name="pixmapFill" type="s100Symbol:PixmapFill" substitutionGroup="areaFillBase"/>

  <xs:element name="symbolFill" type="s100Symbol:SymbolFill" substitutionGroup="areaFillBase"/>

  <xs:element name="hatchFill" type="s100Symbol:HatchFill" substitutionGroup="areaFillBase"/>
</xs:schema>
```

**9-A-7.1.3. Sample Area fill XML**

```
<?xml version="1.0" encoding="UTF-8"?>
<colorFill xmlns:xsi="http://www.w3.org/2001/XMLSchema-instance"
xsi:noNamespaceSchemaLocation="S100AreaFill.xsd">
  <color transparency="0.5">NODTA</color>
</colorFill>
```

**9-A-7.1.4. S-100 Pixmap**

```
<?xml version="1.0" encoding="UTF-8"?>
<xs:schema xmlns:xs="http://www.w3.org/2001/XMLSchema"
xmlns:s100Symbol="http://www.iho.int/S100SymbolDefinition">
  <xs:import namespace="http://www.iho.int/S100SymbolDefinition"
schemaLocation="S100SymbolDefinition.xsd"/>

  <xs:simpleType name="ColorId">
    <xs:restriction base="xs:string">
      <xs:minLength value="1"/>
      <xs:maxLength value="3"/>
      <xs:pattern value="[a-zA-Z0-9_]+"/>
    </xs:restriction>
  </xs:simpleType>

  <xs:complexType name="Pixel">
    <xs:simpleContent>
      <xs:extension base="ColorId">
        <xs:attribute name="x" type="xs:nonNegativeInteger" use="required"/>
        <xs:attribute name="y" type="xs:nonNegativeInteger" use="required"/>
      </xs:extension>
    </xs:simpleContent>
  </xs:complexType>

  <xs:complexType name="ColorMapItem">
    <xs:complexContent>
      <xs:extension base="s100Symbol:Color">
        <xs:attribute name="id" type="ColorId" use="required"/>
      </xs:extension>
    </xs:complexContent>
  </xs:complexType>

  <xs:complexType name="ColorMap">
    <xs:sequence>
      <xs:element name="color" type="ColorMapItem" minOccurs="1" maxOccurs="unbounded"/>
    </xs:sequence>
  </xs:complexType>

  <xs:complexType name="Pixmap">
    <xs:sequence>
      <xs:element name="description" type="xs:string" minOccurs="0" maxOccurs="1"/>
      <xs:element name="width" type="xs:positiveInteger"/>
      <xs:element name="height" type="xs:positiveInteger"/>
      <xs:element name="colorMap" type="ColorMap">
        <xs:key name="colorKey">
          <xs:selector xpath="color"/>
          <xs:field xpath="@id"/>
        </xs:key>
      </xs:element>
      <xs:element name="background" type="ColorId"/>
      <xs:element name="pixel" type="Pixel" minOccurs="0" maxOccurs="unbounded"/>
    </xs:sequence>
```

```

</xs:complexType>

<xs:element name="pixmap" type="Pixmap">
  <xs:keyref name="pixelRef" refer="colorKey">
    <xs:selector xpath="pixel"/>
    <xs:field xpath="."/>
  </xs:keyref>
  <xs:keyref name="backgroundRef" refer="colorKey">
    <xs:selector xpath="background"/>
    <xs:field xpath="."/>
  </xs:keyref>
  <xs:unique name="positionUnique">
    <xs:selector xpath="pixel"/>
    <xs:field xpath="@x"/>
    <xs:field xpath="@y"/>
  </xs:unique>
</xs:element>

</xs:schema>

```

#### 9-A-7.1.5. Sample Pixmap

```

<?xml version="1.0" encoding="UTF-8"?>
<pixmap xmlns:xsi="http://www.w3.org/2001/XMLSchema-instance"
xsi:noNamespaceSchemaLocation="S100Pixmap.xsd">
  <description>Pixmap for a pixmap pattern fill for an area which is not sufficiently described
to be symbolized, or for which no symbol exists in the symbol library.</description>
  <width>8</width>
  <height>16</height>
  <colorMap>
    <color id="0" transparency="1.0">#000000</color>
    <color id="A">CHMGD</color>
  </colorMap>
  <background>0</background>
  <pixel x="2" y="0">A</pixel>
  <pixel x="3" y="0">A</pixel>
  <pixel x="4" y="0">A</pixel>
  <pixel x="5" y="0">A</pixel>
  <pixel x="1" y="1">A</pixel>
  <pixel x="6" y="1">A</pixel>
  <pixel x="0" y="2">A</pixel>
  <pixel x="7" y="2">A</pixel>
  <pixel x="0" y="3">A</pixel>
  <pixel x="7" y="3">A</pixel>
  <pixel x="7" y="4">A</pixel>
  <pixel x="7" y="5">A</pixel>
  <pixel x="6" y="6">A</pixel>
  <pixel x="5" y="7">A</pixel>
  <pixel x="4" y="8">A</pixel>
  <pixel x="3" y="9">A</pixel>
  <pixel x="3" y="10">A</pixel>
  <pixel x="3" y="11">A</pixel>
  <pixel x="3" y="14">A</pixel>
  <pixel x="3" y="15">A</pixel>
</pixmap>

```

**9-A-7.1.6. Sample Catalogue XML**

```

<?xml version="1.0" encoding="UTF-8"?>
<portrayalCatalog xmlns:xsi="http://www.w3.org/2001/XMLSchema-instance"
xsi:noNamespaceSchemaLocation="s100PortrayalCatalog.xsd" productId="" version="">
  <pixmaps>
    <pixmap id="1">
      <fileName>file://pixmaps/bla.xml</fileName>
      <fileType>Pixmap</fileType>
      <fileFormat>XML</fileFormat>
    </pixmap>
    <pixmap id="2">
      <fileName>file://pixmaps/blub.xml</fileName>
      <fileType>Pixmap</fileType>
      <fileFormat>XML</fileFormat>
    </pixmap>
  </pixmaps>
  <colorProfiles>
    <colorProfile id="day">
      <description>
        <name>Day</name>
        <description>The colour profile for the day color schema</description>
        <language>en</language>
      </description>
      <fileName>file://colorProfiles/day.xml</fileName>
      <fileType>ColorProfile</fileType>
      <fileFormat>XML</fileFormat>
    </colorProfile>
    <colorProfile id="dusk">
      <description>
        <name>Dusk</name>
        <description>The colour profile for the dusk color schema</description>
        <language>en</language>
      </description>
      <fileName>file://colorProfiles/dusk.xml</fileName>
      <fileType>ColorProfile</fileType>
      <fileFormat>XML</fileFormat>
    </colorProfile>
    <colorProfile id="night">
      <description>
        <name>Night</name>
        <description>The colour profile for the night color schema</description>
        <language>en</language>
      </description>
      <fileName>file://colorProfiles/night.xml</fileName>
      <fileType>ColorProfile</fileType>
      <fileFormat>XML</fileFormat>
    </colorProfile>
  </colorProfiles>
  <symbols>
    <symbol id="sym1">
      <fileName>file://symbols/sym1.svg</fileName>
      <fileType>Symbol</fileType>
      <fileFormat>SVG</fileFormat>
    </symbol>
    <symbol id="sym2">
      <fileName>file://symbols/sym2.svg</fileName>
      <fileType>Symbol</fileType>
      <fileFormat>SVG</fileFormat>
    </symbol>
  </symbols>

```

```

<lineStyles>
  <lineStyle id="42">
    <fileName>file://lineStyles/solid.xml</fileName>
    <fileType>LineStyle</fileType>
    <fileFormat>XML</fileFormat>
  </lineStyle>
</lineStyles>
<areaFills/>
<fonts/>
<viewingGroups>
  <viewingGroup id="11009"/>
  <viewingGroup id="17004"/>
  <viewingGroup id="22334"/>
  <viewingGroup id="24111"/>
  <viewingGroup id="27000"/>
  <viewingGroup id="27001"/>
  <viewingGroup id="37000"/>
  <viewingGroup id="37001"/>
</viewingGroups>
<foundationMode>
  <viewingGroup>11009</viewingGroup>
  <viewingGroup>17004</viewingGroup>
</foundationMode>
<viewingGroupLayers>
  <viewingGroupLayer id="a">
    <viewingGroup>22334</viewingGroup>
    <viewingGroup>24111</viewingGroup>
  </viewingGroupLayer>
  <viewingGroupLayer id="b">
    <viewingGroup>27000</viewingGroup>
    <viewingGroup>27001</viewingGroup>
  </viewingGroupLayer>
  <viewingGroupLayer id="c">
    <viewingGroup>37000</viewingGroup>
    <viewingGroup>37001</viewingGroup>
  </viewingGroupLayer>
</viewingGroupLayers>
<displayModes>
  <displayMode id="1">
    <description>
      <name>Standard</name>
      <description>The standard display</description>
      <language>en</language>
    </description>
    <viewingGroupLayer>a</viewingGroupLayer>
    <viewingGroupLayer>b</viewingGroupLayer>
  </displayMode>
</displayModes>
<displayPlane>
  <displayPlane id="U">
    <description>
      <name>Under Radar</name>
      <description></description>
      <language>en</language>
    </description>
    <description>
      <name>Unter Radar</name>
      <description></description>
      <language>de</language>
    </description>
  </displayPlane>
</displayPlane>

```

```

</displayPlane>
  <displayPlane id="O">
    <description>
      <name>Over Radar</name>
      <description></description>
      <language>en</language>
    </description>
    <description>
      <name>Über Radar</name>
      <description></description>
      <language>de</language>
    </description>
  </displayPlane>
</displayPlane>
<context>
  <parameter id="safetyDepth">
    <type>Double</type>
    <default>5.0</default>
  </parameter>
  <parameter id="safetyContour">
    <type>Double</type>
    <default>5.0</default>
  </parameter>
</context>
<rules>
  <ruleFile id="1">
    <fileName>file://rules/main.xsl</fileName>
    <fileType>Rule</fileType>
    <fileFormat>XSLT</fileFormat>
    <ruleType>TopLevelTemplate</ruleType>
  </ruleFile>
  <ruleFile id="2">
    <fileName>file://rules/depare.xslt</fileName>
    <fileType>Rule</fileType>
    <fileFormat>XSLT</fileFormat>
    <ruleType>SubTemplate</ruleType>
  </ruleFile>
</rules>
</portrayalCatalog>

```



## Appendix 9-B XML Schemas (informative)

### 9-B-1. Preface

This standard describes a base schema that contains base types to be used within a schema for a data product. In such a schema the real feature types and information types will be defined with their properties. Such properties are attributes or associations. Spatial types have to be derived from the appropriate base types as well.

This section will describe how such a schema can be created. Techniques will be introduced to map the data model from a feature catalogue to an input schema for portrayal. Although the schema can cover the entire data model it is sufficient to model only the part that is relevant for portrayal.

### 9-B-2. Importing the base schema

The product schema will be based on the S100 base schema. Therefore the base schema must be made available within the product schema. This can be achieved by the `xs:import` instruction.

```
<xs:import
  namespace="http://www.ihp.int/S100BaseModel"
  schemaLocation="S100BaseModel.xsd"/>
```

### 9-B-3. Spatial Objects

Since all spatial types in the base schema are abstract there must be derived types in the product schema. Even if no additional properties are added to the base type, the advantage is that all spatial types belongs to the same namespace the rest of the types defined in the product schema. In the following example a spatial type `Point` is derived from `s100:Point` and an association is added to an information type defining the spatial quality.

```
<xs:complexType name="Point">
  <xs:complexContent>
    <xs:extension base="s100:Point">
      <xs:sequence>
        <xs:element name="spatialQuality" type="s100:InformationAssociation" minOccurs="0"/>
      </xs:sequence>
    </xs:extension>
  </xs:complexContent>
</xs:complexType>
```

### 9-B-4. Information types and feature types

The portrayal of many feature types depends on some attributes. As a simple example we assume a feature type 'Beacon, cardinal'. The portrayal should only depend on the attribute 'Category of cardinal mark'. The definition of that feature type would look like.

```
<xs:complexType name="BeaconCardinal">
  <xs:complexContent>
    <xs:extension base="s100:Feature">
      <xs:sequence>
        <xs:element name="categoryOfCardinalMark" nillable="true" type="xs:int"/>
      </xs:sequence>
    </xs:extension>
  </xs:complexContent>
</xs:complexType>
```

```

</xs:extension>
</xs:complexContent>
</xs:complexType>

```

An instance looks like:

```

<BeaconCardinal id="2">
  <s100:Point ref="3"/>
  <categoryOfCardinalMark>3</categoryOfCardinalMark>
</BeaconCardinal>

```

A feature hierarchy can be introduced to avoid redundant definitions. Assuming that all feature types of a data product can have an association to a note (an information type), an abstract type with this property can be introduced and other feature types from this type instead from s100:Feature can be derived.

```

<xs:complexType name="Feature" abstract="true">
  <xs:complexContent base="s100:Feature">
    <xs:extension base="s100:Feature">
      <xs:sequence>
        <xs:element name="noteAssociation" type="s100:InformationAssociation"
          minOccurs="0" maxOccurs="unbounded"/>
      </xs:sequence>
    </xs:extension>
  </xs:complexContent>
</xs:complexType>

```

The beacon, cardinal type is defined now:

```

<xs:complexType name="BeaconCardinal">
  <xs:complexContent>
    <xs:extension base="Feature">
      <xs:sequence>
        <xs:element name="categoryOfCardinalMark" nillable="true" type="xs:int"/>
      </xs:sequence>
    </xs:extension>
  </xs:complexContent>
</xs:complexType>

```

The instance may look like:

```

<BeaconCardinal id="2">
  <s100:Point ref="3"/>
  <noteAssociation role="aNote" informationRef="1"/>
  <categoryOfCardinalMark>3</categoryOfCardinalMark>
</BeaconCardinal>

```

Information types are very similar to feature types. Here are two examples.

The first defines an information type for carrying quality information for spatial types.

```

<xs:complexType name="SpatialQuality">
  <xs:complexContent>

```

```

<xs:extension base="s100:Information">
  <xs:sequence>
    <xs:element name="qualityOfPosition" type="xs:int"/>
  </xs:sequence>
</xs:extension>
</xs:complexContent>
</xs:complexType>

```

The second example shows a note type for general notes that can be associated to any feature type.

```

<xs:complexType name="ChartNote">
  <xs:complexContent>
    <xs:extension base="s100:Information">
      <xs:sequence>
        <xs:element name="note" type="Note" maxOccurs="unbounded"/>
      </xs:sequence>
    </xs:extension>
  </xs:complexContent>
</xs:complexType>

```

The element `<note>` in the example corresponds here to a complex attribute. See the section on complex attributes for more details.

### 9-B-5. Associations

Associations are named relationships between objects. We have two types of associations: information associations for relationships between any object and an information type and feature associations for relationships between two feature types. The associations will be realized in the schema by elements that have the name from the camelCase code of the association. They are of type `s100:InformationAssociation` or `s100:FeatureAssociation`. As an example we extend the beacon cardinal type with a feature association to the underlying area.

```

<xs:complexType name="BeaconCardinal">
  <xs:complexContent>
    <xs:extension base="Feature">
      <xs:sequence>
        <xs:element name="underlyingArea" type="s100:FeatureAssociation" minOccurs="0"/>
        <xs:element name="categoryOfCardinalMark" nillable="true" type="xs:int"/>
      </xs:sequence>
    </xs:extension>
  </xs:complexContent>
</xs:complexType>

```

The instance now is:

```

<BeaconCardinal id="2">
  <s100:Point ref="3"/>
  <noteAssociation role="aNote" informationRef="1"/>
  <underlyingArea role="area" featureRef="3"/>
  <categoryOfCardinalMark>3</categoryOfCardinalMark>
</BeaconCardinal>

```

### 9-B-6. Complex attributes

Complex attributes can be easily defined as complex types in XML. As an example we have a look at the complex attribute note of our ChartNote information type. This attribute comprises two simple data types the text and the language of the text. The definition is:

```
<xs:complexType name="Note">
  <xs:sequence>
    <xs:element name="noteText" type="xs:string"/>
    <xs:element name="language" type="xs:string"/>
  </xs:sequence>
</xs:complexType>
```

An instance of the information type ChartNote could be:

```
<ChartNote id="1">
  <note>
    <noteText>Hello world!</noteText>
    <language>en</language>
  </note>
  <note>
    <noteText>Hallo Welt!</noteText>
    <language>de</language>
  </note>
</ChartNote>
```

### 9-B-7. Sample S-101 Product Input Schema

```
<?xml version="1.0" encoding="UTF-8"?>
<xs:schema xmlns:xs="http://www.w3.org/2001/XMLSchema"
  xmlns:s100="http://www.iho.int/S100BaseModel">
  <xs:import namespace="http://www.iho.int/S100BaseModel"
    schemaLocation="S100BaseModel.xsd"/>

  <!-- INFORMATION ASSOCIATIONS -->
  <xs:complexType name="SpatialQualityAssociation">
    <xs:complexContent>
      <xs:extension base="s100:InformationAssociation"/>
    </xs:complexContent>
  </xs:complexType>
  <!-- FEATURE ASSOCIATIONS -->
  <xs:complexType name="UnderlyingAreaAssociation">
    <xs:complexContent>
      <xs:extension base="s100:FeatureAssociation"/>
    </xs:complexContent>
  </xs:complexType>

  <!-- INFORMATION TYPES -->
  <xs:complexType name="SpatialQuality">
    <xs:complexContent>
      <xs:extension base="s100:Information">
        <xs:sequence>
          <xs:element name="qualityOfPosition"/>
        </xs:sequence>
      </xs:extension>
    </xs:complexContent>
  </xs:complexType>

  <xs:complexType name="Note">
    <xs:sequence minOccurs="1" maxOccurs="unbounded">
      <xs:element name="noteText" type="xs:string"/>
    </xs:sequence>
  </xs:complexType>
```

```

    <xs:element name="language" type="xs:language"/>
  </xs:sequence>
</xs:complexType>

<xs:complexType name="ChartNote">
  <xs:complexContent>
    <xs:extension base="s100:Information">
      <xs:sequence>
        <xs:element name="note" type="Note" maxOccurs="unbounded"/>
      </xs:sequence>
    </xs:extension>
  </xs:complexContent>
</xs:complexType>

<!-- GROUP OF ALL INFORMATION TYPES -->
<xs:group name="InformationType">
  <xs:choice>
    <xs:element name="SpatialQuality" type="SpatialQuality"/>
    <xs:element name="ChartNote" type="ChartNote"/>
  </xs:choice>
</xs:group>

<!-- SPATIAL TYPES (WITH SPATIAL QUALITY RELATIONS FOR POINTS,
POINTSETS, AND CURVES-->
<xs:complexType name="Point">
  <xs:complexContent>
    <xs:extension base="s100:Point">
      <xs:sequence>
        <xs:element name="spatialQuality" type="s100:InformationAssociation" minOccurs="0"/>
      </xs:sequence>
    </xs:extension>
  </xs:complexContent>
</xs:complexType>

<xs:complexType name="MultiPoint">
  <xs:complexContent>
    <xs:extension base="s100:MultiPoint">
      <xs:sequence>
        <xs:element name="spatialQuality" type="s100:InformationAssociation" minOccurs="0"/>
      </xs:sequence>
    </xs:extension>
  </xs:complexContent>
</xs:complexType>

<xs:complexType name="Curve">
  <xs:complexContent>
    <xs:extension base="s100:Curve">
      <xs:sequence>
        <xs:element name="spatialQuality" type="s100:InformationAssociation" minOccurs="0"/>
      </xs:sequence>
    </xs:extension>
  </xs:complexContent>
</xs:complexType>

<xs:complexType name="CompositeCurve">
  <xs:complexContent>
    <xs:extension base="s100:CompositeCurve"/>
  </xs:complexContent>
</xs:complexType>

```

```

<xs:complexType name="Surface">
  <xs:complexContent>
    <xs:extension base="s100:Surface"/>
  </xs:complexContent>
</xs:complexType>

<!-- FEATURE TYPES -->
<!-- BASE CLASS FOR ALL FEATURES WITH NOTE ASSOCIATION -->
<xs:complexType name="Feature" abstract="true">
  <xs:complexContent>
    <xs:extension base="s100:Feature">
      <xs:sequence>
        <xs:element name="noteAssociation" type="s100:InformationAssociation" minOccurs="0"
maxOccurs="unbounded"/>
      </xs:sequence>
    </xs:extension>
  </xs:complexContent>
</xs:complexType>

<xs:complexType name="DepthArea">
  <xs:complexContent>
    <xs:extension base="Feature">
      <xs:sequence>
        <xs:element name="depthValue1" type="xs:double" nillable="true" minOccurs="0"
maxOccurs="1"/>
        <xs:element name="depthValue2" type="xs:double" nillable="true" minOccurs="0"
maxOccurs="1"/>
      </xs:sequence>
    </xs:extension>
  </xs:complexContent>
</xs:complexType>

<xs:complexType name="DepthContour">
  <xs:complexContent>
    <xs:extension base="Feature">
      <xs:sequence>
        <xs:element name="valueOfDepthContour" type="xs:double" nillable="true"
minOccurs="0" maxOccurs="1"/>
      </xs:sequence>
    </xs:extension>
  </xs:complexContent>
</xs:complexType>

<xs:complexType name="BeaconCardinal">
  <xs:complexContent>
    <xs:extension base="Feature">
      <xs:sequence>
        <xs:element name="underlyingArea" type="s100:FeatureAssociation" minOccurs="0"/>
        <xs:element name="categoryOfCardinalMark" type="xs:int" nillable="true" minOccurs="0"
maxOccurs="1"/>
      </xs:sequence>
    </xs:extension>
  </xs:complexContent>
</xs:complexType>

<xs:complexType name="Landmark">
  <xs:complexContent>
    <xs:extension base="Feature">
      <xs:sequence>
        <xs:element name="categoryOfLandmark" type="xs:int" nillable="true" minOccurs="0"/>
      </xs:sequence>
    </xs:extension>
  </xs:complexContent>
</xs:complexType>

```

```

        <xs:element name="function" type="xs:string" minOccurs="0"/>
        <xs:element name="visuallyConspicuous" type="xs:int" nillable="true" minOccurs="0"/>
        <xs:element name="objectName" type="xs:string" nillable="true" minOccurs="0"/>
    </xs:sequence>
</xs:extension>
</xs:complexContent>
</xs:complexType>

<!-- GROUP OF ALL FEATURES -->
<xs:group name="Feature">
    <xs:choice>
        <xs:element name="DepthArea" type="DepthArea"/>
        <xs:element name="DepthContour" type="DepthContour"/>
        <xs:element name="BeaconCardinal" type="BeaconCardinal"/>
        <xs:element name="Landmark" type="Landmark"/>
    </xs:choice>
</xs:group>

<!-- THE ELEMENTS OF THE DATA SET -->
<xs:complexType name="InformationTypes">
    <xs:sequence minOccurs="0" maxOccurs="unbounded">
        <xs:group ref="InformationType"/>
    </xs:sequence>
</xs:complexType>
<xs:complexType name="Points">
    <xs:sequence>
        <xs:element name="Point" type="Point" minOccurs="0" maxOccurs="unbounded"/>
    </xs:sequence>
</xs:complexType>

<xs:complexType name="MultiPoints">
    <xs:sequence>
        <xs:element name="MultiPoint" type="MultiPoint" minOccurs="0" maxOccurs="unbounded"/>
    </xs:sequence>
</xs:complexType>

<xs:complexType name="Curves">
    <xs:sequence>
        <xs:element name="Curve" type="Curve" minOccurs="0" maxOccurs="unbounded"/>
    </xs:sequence>
</xs:complexType>

<xs:complexType name="CompositeCurves">
    <xs:sequence>
        <xs:element name="CompositeCurve" type="CompositeCurve" minOccurs="0"
maxOccurs="unbounded"/>
    </xs:sequence>
</xs:complexType>

<xs:complexType name="Surfaces">
    <xs:sequence>
        <xs:element name="Surface" type="Surface" minOccurs="0" maxOccurs="unbounded"/>
    </xs:sequence>
</xs:complexType>

<xs:complexType name="Features">
    <xs:sequence minOccurs="0" maxOccurs="unbounded">
        <xs:group ref="Feature"/>
    </xs:sequence>
</xs:complexType>

```

```

<xs:complexType name="Dataset">
  <xs:sequence>
    <!-- THE INFORMATION TYPES -->
    <xs:element name="InformationTypes" type="InformationTypes" minOccurs="0">
      <xs:key name="informationKey">
        <xs:selector xpath="*/">
        <xs:field xpath="@id"/>
      </xs:key>
    </xs:element>
    <!-- THE POINTS -->
    <xs:element name="Points" type="Points" minOccurs="0">
      <xs:key name="pointKey">
        <xs:selector xpath="Point"/>
        <xs:field xpath="@id"/>
      </xs:key>
    </xs:element>
    <!-- THE MULTI POINTS -->
    <xs:element name="MultiPoints" type="MultiPoints" minOccurs="0">
      <xs:key name="multiPointKey">
        <xs:selector xpath="MultiPoint"/>
        <xs:field xpath="@id"/>
      </xs:key>
    </xs:element>
    <!-- THE CURVES -->
    <xs:element name="Curves" type="Curves" minOccurs="0">
      <xs:key name="curveKey">
        <xs:selector xpath="Curve"/>
        <xs:field xpath="@id"/>
      </xs:key>
    </xs:element>
    <!-- THE COMPOSITE CURVES -->
    <xs:element name="CompositeCurves" type="CompositeCurves" minOccurs="0">
      <xs:key name="compositeCurveKey">
        <xs:selector xpath="CompositeCurve"/>
        <xs:field xpath="@id"/>
      </xs:key>
    </xs:element>
    <!-- THE SURFACES -->
    <xs:element name="Surfaces" type="Surfaces" minOccurs="0">
      <xs:key name="surfaceKey">
        <xs:selector xpath="Surface"/>
        <xs:field xpath="@id"/>
      </xs:key>
    </xs:element>
    <!-- THE FEATURE TYPES -->
    <xs:element name="Features" type="Features">
      <xs:key name="featureKey">
        <xs:selector xpath="*/">
        <xs:field xpath="@id"/>
      </xs:key>
    </xs:element>
  </xs:sequence>
</xs:complexType>

<!-- THE ROOT ELEMENT (OF TYPE DataSet) -->
<xs:element name="Dataset" type="Dataset">

```



```

<!-- KEY REFERENCES -->
<xs:keyref name="informationRef" refer="informationKey">
  <xs:selector xpath="./"/*"/>
  <xs:field xpath="@informationRef"/>
</xs:keyref>
<xs:keyref name="pointRef" refer="pointKey">
  <xs:selector xpath="Features/*/s100:Point | Curves/Curve/s100:Boundary"/>
  <xs:field xpath="@ref"/>
</xs:keyref>
<xs:keyref name="multiPointRef" refer="multiPointKey">
  <xs:selector xpath="Features/*/s100:MultiPoint"/>
  <xs:field xpath="@ref"/>
</xs:keyref>
<xs:keyref name="curveRef" refer="curveKey">
  <xs:selector xpath="Features/*/s100:Curve | CompositeCurves/CompositeCurve/s100:Curve |
Surfaces/Surface/s100:Ring/s100:Curve"/>
  <xs:field xpath="@ref"/>
</xs:keyref>
<xs:keyref name="compositeCurveRef" refer="compositeCurveKey">
  <xs:selector xpath="Features/*/s100:CompositeCurve |
CompositeCurves/CompositeCurve/s100:CompositeCurve |
Surfaces/Surface/s100:Ring/s100:CompositeCurve"/>
  <xs:field xpath="@ref"/>
</xs:keyref>
<xs:keyref name="surfaceRef" refer="surfaceKey">
  <xs:selector xpath="Features/*/s100:Surface"/>
  <xs:field xpath="@ref"/>
</xs:keyref>
<xs:keyref name="featureRef" refer="featureKey">
  <xs:selector xpath="Features/*/*"/>
  <xs:field xpath="@featureRef"/>
</xs:keyref>
</xs:element>

</xs:schema>

```

### 9-B-8. Example Product Input Dataset

```

<?xml version="1.0" encoding="UTF-8"?>
<Dataset xmlns:xsi="http://www.w3.org/2001/XMLSchema-instance"
xsi:noNamespaceSchemaLocation="S101DataModel.xsd"
xmlns:s100="http://www.ihp.int/S100BaseModel">

```

```

<!-- THE INFORMATION TYPES -->

```

```

<InformationTypes xmlns="">

```

```

<!-- A CHART NOTE -->

```

```

<ChartNote id="1">

```

```

  <note>

```

```

    <noteText>Hello world!</noteText>

```

```

    <language>en</language>

```

```

  </note>

```

```

  <note>

```

```

    <noteText>Hallo Welt!</noteText>

```

```

    <language>de</language>

```

```

  </note>

```

```

</ChartNote>

```

```

<!-- AN INFORMATION OBJECT INDICATING SPATIAL QUALITY -->

```

```

<SpatialQuality id="2">

```

```

    <qualityOfPosition>2</qualityOfPosition>
  </SpatialQuality>

</InformationTypes>

<!-- THE SPATIAL OBJECTS -->
<!-- SOME POINTS -->
<Points>
  <Point id="1">
    <Coordinate2D>
      <x>1.0</x>
      <y>2.0</y>
    </Coordinate2D>
  </Point>

  <Point id="2">
    <Coordinate2D>
      <x>1.0</x>
      <y>2.0</y>
    </Coordinate2D>
  </Point>

  <Point id="3">
    <Coordinate2D>
      <x>1.0</x>
      <y>2.0</y>
    </Coordinate2D>
  </Point>
</Points>

<!-- POINT SETS -->
<MultiPoints>
  <MultiPoint id="1">
    <Coordinate3D>
      <x>2.0</x>
      <y>3.0</y>
      <z>5.3</z>
    </Coordinate3D>
    <Coordinate3D>
      <x>5</x>
      <y>6</y>
      <z>7</z>
    </Coordinate3D>
  </MultiPoint>

  <MultiPoint id="2">
    <Coordinate3D>
      <x>2.0</x>
      <y>2.5</y>
      <z>5.3</z>
    </Coordinate3D>
    <Coordinate3D>
      <x>2.0</x>
      <y>2.5</y>
      <z>5.3</z>
    </Coordinate3D>
  </MultiPoint>

  <MultiPoint id="5">
    <Coordinate3D>

```

```

        <x>2.0</x>
        <y>2.5</y>
        <z>5.3</z>
    </Coordinate3D>
</MultiPoint>
</MultiPoints>

<!-- CURVES -->
<Curves>
  <Curve id="1">
    <Boundary ref="1" boundaryType="Begin"/>
    <Boundary ref="1" boundaryType="End"/>
    <Segment interpolation="Loxodromic">
      <ControlPoint>
        <x>1</x>
        <y>2</y>
      </ControlPoint>
      <ControlPoint>
        <x>1</x>
        <y>2</y>
      </ControlPoint>
    </Segment>
  </Curve>

  <Curve id="2">
    <Boundary ref="2" boundaryType="Begin"/>
    <Boundary ref="3" boundaryType="End"/>
    <Segment interpolation="Loxodromic">
      <ControlPoint>
        <x>3.6</x>
        <y>4.5</y>
      </ControlPoint>
      <ControlPoint>
        <x>3.8</x>
        <y>4.7</y>
      </ControlPoint>
    </Segment>
  </Curve>

  <Curve id="3">
    <Segment interpolation="Loxodromic">
      <ControlPoint>
        <x>3.6</x>
        <y>4.5</y>
      </ControlPoint>
      <ControlPoint>
        <x>3.8</x>
        <y>4.7</y>
      </ControlPoint>
    </Segment>
    <spatialQuality role="qualityOfPosition" informationRef="2"/>
  </Curve>

  <Curve id="5">
    <Segment interpolation="Loxodromic">
      <ControlPoint>
        <x>3.6</x>
        <y>4.5</y>
      </ControlPoint>
      <ControlPoint>

```

```

        <x>3.8</x>
        <y>4.7</y>
      </ControlPoint>
    <ControlPoint>
      <x>7</x>
      <y>5.3</y>
    </ControlPoint>
  </Segment>
</Curve>
<Curve id="6">
  <CircleByCenterPoint interpolation="CircularArcCenterPointWithRadius" radius="5.0">
    <ControlPoint>
      <x>2.0</x>
      <y>3.0</y>
    </ControlPoint>
  </CircleByCenterPoint>
  <ArcByCenterPoint interpolation="CircularArcCenterPointWithRadius" radius="5.0"
startAngle="23.0" angularDistance="-45.0">
    <ControlPoint>
      <x>12.4</x>
      <y>22</y>
    </ControlPoint>
  </ArcByCenterPoint>
</Curve>

</Curves>

<!-- COMPOSITE CURVES -->
<CompositeCurves>
  <CompositeCurve id="1">
    <Curve ref="1" orientation="Forward"/>
    <Curve ref="5" orientation="Reverse"/>
  </CompositeCurve>
  <CompositeCurve id="2">
    <Curve ref="3" orientation="Forward"/>
    <CompositeCurve ref="1" orientation="Reverse"/>
  </CompositeCurve>
</CompositeCurves>

<!-- SURFACES -->
<Surfaces>
  <Surface id="1">
    <Ring type="Outer">
      <Curve ref="1" orientation="Forward"/>
      <CompositeCurve ref="1" orientation="Reverse"/>
    </Ring>
    <Ring type="Inner">
      <Curve ref="5" orientation="Reverse"/>
    </Ring>
  </Surface>
</Surfaces>

<!-- THE FEATURE TYPES OF THE DATA SET -->
<Features>
  <DepthArea id="1" primitive="Surface">
    <depthValue1 xsi:nil="true"/>
    <depthValue2>0</depthValue2>
  </DepthArea>

  <BeaconCardinal id="2" primitive="Point">

```

```

    <Point ref="3"/>
    <Point ref="1"/>
    <noteAssociation role="aNote" informationRef="1"/>
    <underlyingArea role="area" featureRef="3"/>
    <categoryOfCardinalMark>3</categoryOfCardinalMark>
  </BeaconCardinal>

  <DepthArea id="3" primitive="Surface">
    <Surface ref="1"/>
    <depthValue1>0</depthValue1>
    <depthValue2>5</depthValue2>
  </DepthArea>

  <DepthContour id="4" primitive="Curve">
    <Curve ref="2" orientation="Forward"/>
    <CompositeCurve ref="2" orientation="Reverse"/>
  </DepthContour>

  <DepthContour id="5" primitive="Curve">
    <Curve ref="2" orientation="Forward"/>
    <Curve ref="3" orientation="Reverse"/>
  </DepthContour>

  <Landmark id="6" primitive="Point">
    <Point ref="2"/>
    <categoryOfLandmark>15</categoryOfLandmark>
    <function>21</function>
    <visuallyConspicuous>1</visuallyConspicuous>
  </Landmark>

  <DepthArea id="7" primitive="Surface">
    <depthValue1>5</depthValue1>
    <depthValue2>10</depthValue2>
  </DepthArea>

  <DepthArea id="8" primitive="Surface">
    <depthValue1>10</depthValue1>
    <depthValue2>20</depthValue2>
  </DepthArea>

  <DepthArea id="9" primitive="Surface">
    <depthValue1>20</depthValue1>
  </DepthArea>

  <Landmark id="10" primitive="Point">
    <categoryOfLandmark>5</categoryOfLandmark>
  </Landmark>

  <Landmark id="11" primitive="Point"/>

  <Landmark id="12" primitive="Point">
    <categoryOfLandmark>17</categoryOfLandmark>
    <function>33</function>
    <objectName>A name</objectName>
  </Landmark>

  <Landmark id="13" primitive="Point">
    <visuallyConspicuous>1</visuallyConspicuous>
    <objectName>No display name</objectName>
  </Landmark>

```

</Features>

</Dataset>



## Appendix 9-C

# SVG Profile

### (Normative)

#### 9C-1 Introduction

This appendix describes the subset of SVG elements that have been used in the creation of S-100 SVG symbols and covers the set of SVG elements and associated attributes and properties that are in use by S-100.

The S-100 SVG profile is a subset of the SVG Tiny 1.2 profile  
<http://www.w3.org/TR/SVGTiny12/>

#### 9C-2 Top Level SVG

The main svg element carries this indication as well as properties of each individual svg symbol as xml attributes.

```
<svg xmlns="http://www.w3.org/2000/svg" version="1.2" baseProfile="tiny"
xml:space="preserve" style="shape-rendering:geometricPrecision; fill-rule:evenodd;"
width="4.34mm" height="5.35mm" viewBox="-2.22 -2.79 4.34 5.35">
```

##### 9C-2.1 Coordinate System

The overall width and height of the symbol are defined in mm. The viewBox covers the range of coordinates used for the symbol. The pivot point of the symbol is designed to be at the 0,0 position.

The default coordinate system used for S-100 SVG has the origin in the upper left corner with the x-axis pointing to the right and the y-axis pointing down.

##### 9C-3.2 Title

The title element is used to carry the name of the symbol.

```
<title>ACHARE02</title>
```

##### 9C-3.3 Description

The description element is used to carry a brief textual description of the symbol.

```
<desc>anchorage area as a point at small scale, or anchor points of mooring trot at large
scale</desc>
```

##### 9C-3.4 Metadata

SVG has a metadata element which allows for the direct inclusion of metadata document fragments from other namespaces. The following example shows how IHO could define the appropriate metadata content for a symbol. The IHO S-100 working group is encouraged to define a metadata schema for use with S-100 symbols.

```
<metadata>
  <iho:S100SVG xmlns:iho="http://www.iho.int/SVGMetadata">
    <iho:Description iho:publisher="IHB" iho:creationDate="2014-06-09"
iho:source="S52Preslib4.0" iho:format="S100SVG" iho:version="0.1"/>
  </iho:S100SVG>
</metadata>
```



## 9C-3 Drawing Elements

The body of the SVG symbol contains the drawing elements. The drawing elements implemented so far include path, rect and circle with details to follow. These drawing elements share some common attributes such as 'class'.

### 9C-3.1 Class

The 'class' attribute is used to assign one or more class names to the element. In the S-100 SVG the class attribute is used to assign style information by way of a CSS stylesheet. It can also be used to filter or control which elements should be shown. Essentially the class tokens can be used as a key to find a set of style instructions in the corresponding Cascading Style Sheet (CSS ). A processing instruction at the head of the SVG symbol indicates the corresponding CSS file.

#### 9C-3.1.1 CSS

```
<?xml-stylesheet href="SVGStyle.css" type="text/css"?>
```

An example excerpt of such a CSS file might be as follows:

```
.layout {display:none} /* used to control visibility of symbolBox, svgBox, pivotPoint (none or
inline) */
.symbolBox {stroke:black;stroke-width:0.32;} /* show the cover of the symbol graphics */
.svgBox {stroke:blue;stroke-width:0.32;} /* show the entire SVG cover */
.pivotPoint {stroke:red;stroke-width:0.64;} /* show the pivot/anchor point, 0,0 */
.sl {stroke-linecap:round;stroke-linejoin:round} /* default line style elements */
.f0 {fill:none} /* no fill */
.sCURSR {stroke:#E38039} /* sRGB line colour for colour token CURSR */
.fCURSR{fill:#E38039} /* sRGB fill colour for colour token CURSR*/
.sCHBLK {stroke:#000000}
.fCHBLK {fill:#000000}
.sCHGRD {stroke:#4C5B63}
.fCHGRD {fill:#4C5B63}
.sCHGRF {stroke:#768C97}
.fCHGRF {fill:#768C97}
.sCHRED {stroke:#EA5471}
.fCHRED {fill:#EA5471}
.sCHGRN {stroke:#52E93A}
.fCHGRN {fill:#52E93A}
.sCHMGD {stroke:#C045D1}
.fCHMGD {fill:#C045D1}
...
```

This mechanism allows for possibility to change the colours used in the symbols by swapping the CSS file with different contents according to the desired colour scheme. Each colour token is encoded for both a stroke style and a fill style. The stroke is used for drawing lines and the fill for filling closed shapes. In the above example the token 'sCHMGD' translates into a 'stroke' property using the sRGB colour #C045D1 and fCHMGD represents a fill operation. Different CSS files would be used for each colour palette with the sRGB values calculated using a formula to convert from the official CIE values.

NOTE: In converting CIE to sRGB, the rendering intent must follow an absolute colorimetry method. Due to the differences in color and luminance performance between individual monitors, any "formula" for conversion from CIE to sRGB must be based on measurements to characterize (calibrate) the monitor in order to meet the color accuracy and separation specified for ECDIS. For interoperability with ECDIS, portrayal of other S-1xx products would need to follow the same rendering intent. [Reference ICC specification, rendering intents]

### 9C-3.2 Style Properties

The style properties used in the draft S-100 SVG symbols include:

- 'stroke' - the pen colour for lines defined with a hexadecimal sRGB value
- 'stroke-width' - the pen width in the same units as the SVG width/height. For S-100 SVG we are using mm.
- 'stroke-opacity' - range of 0.0 (fully transparent) to 1.0 (fully opaque)
- 'fill' - the colour to fill closed shapes defined with a hexadecimal sRGB value
- 'fill-opacity' - range of 0.0 (fully transparent) to 1.0 (fully opaque)
- 'stroke-linecap' – style for the ends of lines, choice of (butt | round | square )
- 'stroke-linejoin' – style for corners within a line path, choice of (miter | round | bevel)
- 'display' – identifies whether the element is to be included/rendered or not. Default is 'inline'. This is used as a way to hide or show the layout elements of the symbol such as the covering box or the pivot point. This way a different CSS file with layout display set to 'inline' can be used when viewing the symbol in a design/engineering view.

### 9C-3.3 Path

```
<path d=" M -2.06,1.36 L -1,2.4 L 0.98,2.4 L 1.96,1.39" class="sl f0 sCHMGD" style="stroke-width: 0.32;"/>
```

```
<path d=" M -5.88,-5.88 L 5.87,-5.88 L 5.87,5.87 L -5.88,5.87 L -5.88,-5.88 Z" class="fDNGHL" style="fill-opacity:0.25;"/>
```

The 'd' attribute carries the path data which describes the outline of a shape. In the current set of SVG symbols the path data is made up of *moveto* 'M' and *lineto* 'L' instructions as well as the *closepath* 'Z' instruction. The *curve* instructions have not yet been used. 'M' and 'L' instructions are followed by a pair of absolute coordinates. Relative coordinates indicated with lowercase 'm' and 'l' instructions are not used. Note that some style elements can be assigned specifically using the 'style' attribute and others are coming from the stylesheet via the class lookups as described above.

### 9C-3.4 Rectangle

```
<rect class="symbolBox layout" fill="none" x="-2.06" y="-2.63" height="5.03" width="4.02"/>
```

The 'rect' command uses 'x' and 'y' to define the upper left corner of the rectangle and the attributes 'width' and 'height' in the user units, mm. Specific style parameters are defined using the 'style' attribute while colours and other common styles are applied via the class token CSS lookups.

### 9C-3.5 Circle

```
<circle class="pivotPoint layout" fill="none" cx="0" cy="0" r="1"/>
```

The 'circle' command uses 'cx' and 'cy' to define the centre of the circle and the attribute 'r' to define the radius in the user units, mm. Specific style parameters are defined using style attributes while colours and other common styles are applied via the class token CSS lookups.



# **S-100 – Part 10a**

## **ISO/IEC 8211 Encoding**

## Contents

10a-1	Scope .....	4
10a-2	Conformance.....	4
10a-3	Normative References .....	4
10a-3.1	Introduction .....	4
10a-3.2	Notations used in this clause .....	4
10a-3.3	Tree structure diagrams .....	4
10a-3.4	Field Tables.....	5
10a-3.5	Data formats.....	6
10a-3.6	Data Descriptive Fields .....	6
10a-4	Common fields .....	7
10a-4.1	Attribute field .....	7
10a-4.1.1	Encoding rules .....	7
10a-4.2	Updating of the Attribute field.....	8
10a-4.3	Attribute field structure .....	10
10a-4.4	Information Association field .....	10
10a-4.4.1	Encoding rules .....	10
10a-4.4.2	Information Association field structure .....	10
10a-5	Data Set Descriptive records .....	11
10a-5.1	Data Set General Information record .....	11
10a-5.1.1	Encoding rules .....	11
10a-5.1.2	Data Set General Information record structure .....	12
10a-5.2	Data Set Coordinate Reference System record .....	15
10a-5.2.1	Encoding rules .....	15
10a-5.2.2	Data Set Coordinate Reference System record structure .....	18
10a-5.3	Information Type record.....	20
10a-5.3.1	Encoding rules .....	20
10a-5.3.2	Information Type record structure.....	21
10a-5.3.3	Information Type Identifier field structure .....	21
10a-5.4	Spatial type records .....	21
10a-5.4.1	Coordinates.....	21
10a-5.4.2	2-D Integer Coordinate Tuple field structure.....	22
10a-5.4.3	3-D Integer Coordinate Tuple field structure.....	22
10a-5.4.4	2-D Floating Point Coordinate Tuple field structure.....	23
10a-5.4.5	3-D Floating Point Coordinate Tuple field structure.....	23
10a-5.4.6	2-D Integer Coordinate List field structure .....	23
10a-5.4.7	3-D Integer Coordinate List field structure .....	23
10a-5.4.8	2-D Floating Point Coordinate List field structure .....	24
10a-5.4.9	3-D Floating Point Coordinate List field structure .....	24
10a-5.5	Point record.....	24
10a-5.5.1	Encoding rules .....	24
10a-5.5.2	Point record structure.....	25
10a-5.6	Multi Point record .....	25
10a-5.6.1	Encoding rules .....	25
10a-5.6.2	Multi Point record structure .....	26
10a-5.7	Curve record .....	27
10a-5.7.1	Encoding rules .....	27
10a-5.7.2	Curve record structure .....	28
10a-5.8	Composite Curve record .....	31
10a-5.8.1	Encoding rules .....	31
10a-5.8.2	Composite Curve record structure .....	32
10a-5.9	Surface Record .....	33
10a-5.9.1	Encoding rules .....	33
10a-5.9.2	Surface Record structure .....	33
10a-5.10	Feature Type record .....	35
10a-5.10.1	Encoding rules .....	35
10a-5.11	Feature Type record structure .....	36
10a-5.11.1	Feature Type Record Identifier field structure .....	36
10a-5.11.2	Feature Object Identifier field structure.....	37

10a-5.11.3	Spatial Association field structure .....	37
10a-5.11.4	Feature Association field.....	37
10a-5.11.5	Theme Association field.....	38
10a-5.11.6	Masked Spatial Type field structure.....	38

## 10a-1 Scope

The international standard ISO/IEC 8211 - *Specification for a data descriptive file for information interchange*, is a means of encapsulating data; it provides a file based mechanism for the transfer of data. This Part specifies an interchange format to facilitate the moving of files containing data records between computer systems. It defines a specific structure which can be used to transmit files containing data type and data structures specific to S-100.

## 10a-2 Conformance

This profile conforms to level 2 of ISO 19106:2004.

## 10a-3 Normative References

The following referenced documents are required for the application of this document. For dated references, only the edition cited applies. For undated references, the latest edition of the referenced document (including amendments) applies.

ISO/IEC 8211:1994, *Specification for a data descriptive file for information interchange Structure implementations*.

### 10a-3.1 Introduction

This chapter specifies the structure of an exchange set at the record and field levels. It further specifies the contents of the physical constructs required for their implementation as ISO/IEC 8211 data records, fields, and subfields. The grouping of records into ISO/IEC 8211 files is considered application specific and is, therefore, described in the relevant product specification. For the encoding only the binary ISO/IEC 8211 format is used.

### 10a-3.2 Notations used in this clause

The specification of the structure of a record is given as a tree structure diagram which comprises the names, linkages and repetition factors of the physical constructs. The detailed specifications of fields and subfields are given in tabular form. Additionally for each field the Data Descriptive field is given. Those fields are used in the Data Descriptive Record (DDR) of an ISO/IEC 8211 conformal data set.

### 10a-3.3 Tree structure diagrams

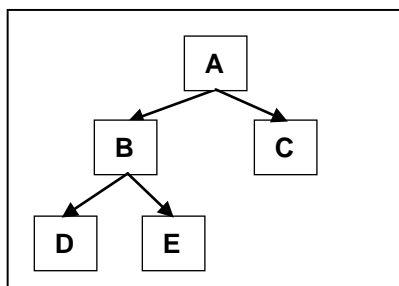


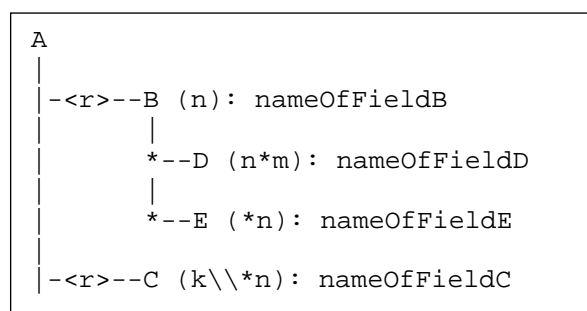
Figure 10a-1

Where A is the root node and parent of node B and node C. Node B is the root of a sub-tree and the parent of nodes D and E.

Nodes are also referred to as the offspring or child of their parents. E.g. node B is the offspring of node A.

The tree structure diagrams must be interpreted in a preorder traversal sequence (top down, left branch first).

For ease of annotation these diagrams are presented vertically in this standard using ASCII characters. In this notation the above diagram becomes:



Where:

A, B, C, ...	ISO/IEC 8211 field tags
<r>	r is the sub-tree cardinality (if missing, r=1) possible values: <0.. 1> zero or one <0 .. *> any number including zero <1.. *> at least one
(n)	the number of subfields is n (fixed number)
(n*m)	subfields are stored as an m by n array with m rows and n columns (n subfields are repeated m times)
(*n)	subfields are stored as a n-column table with an arbitrary number of rows (n subfields are repeating)
(k\\*n)	A concatenation of k subfields and a n-column table (k subfields are followed by n repeating subfields)

The tree structure diagrams define which fields are allowed to be repeated. However, within a record, the degree of repetition of fields will depend on the data that is being encoded. In some cases a particular field may not be required and so will be absent (see clause 2.1). However, in all cases, the pre-order traversal sequence of a data record will be the same as shown in the generic tree structure diagram for that record type.

### 10a-3.4 Field Tables

Each table is preceded by a row in bold outline indicating the field name and field tag. The body of the table specifies the subfield names and labels as well as the ISO/IEC 8211. The subfield specification may include a required value or range constraint. The following is an example of a field table using the Data Set Identification field.

Field Tag: <b>DSID</b>		[Upd] *)		Field Name: Data Set Identification
Subfield name	Label	Format	Subfield content and specification	
Record name	RCNM	b11	{10} **)	
Record identification number	RCID	b14	Range: 1 to 2 <sup>32</sup> -2	
Encoding specification	ENSP	A()	Encoding specification that defines the encoding	
Encoding specification edition	ENED	A()	Edition of the encoding specification	
Product identifier	PRSP	A()	Unique identifier for the data product as specified in the product specification	
Product edition	PRED	A()	Edition of the product specification	
Application profile	PROF	A()	Identifier that specifies a profile within the data product	
Data set name	DSNM	A()	The name of the data set	
Edition number	EDTN	b12	The edition number of the data set	
Update number	UPDN	b12	The update number of the data set	
Issue date	ISDT	A(8)	The issue date Format: YYYYMMDD according to ISO 8601	



- \*) [Upd] indicates that the field is only used for updating (for the DSID field this is used as an example)  
 \*\*) Required binary values are enclosed in {...}

Where:

- 1) **Label** is the ISO/IEC 8211 subfield label, present only in the data descriptive record and required to identify the subfields within a field. A label preceded by "\*" signifies that the subfield and the subsequent ones, repeat within the field. This, therefore, indicates the presence of a 2-D array or table for which the subfield labels provide the column headings (the vector labels of a cartesian label).
- 2) **Format** is the ISO/IEC 8211 binary subfield data format

### 10a-3.5 Data formats

Subfield data formats are specified by ISO/IEC 8211. The allowable data formats are as follows:

Format	Data Type	Omitted values	Remark
A(n)	Character Data	If the subfield has a fixed length the subfield will be filled with blanks (space character) If the subfield length is variable only the unit terminator must be encoded.	n specifies the length of the subfield (number of character) A() indicates a sub field of variable length which must be terminated by the unit delimiter (UT). The encoding of Character Data within this standard must be UTF8 implementation level 1. The appropriate Escape Sequence is: (2/5) (2/15) (4/7) "%/G"
b1w	Unsigned Integer (LSBF *)	The binary value with all bits set to 1 must be used.	w specifies the number of Bytes used. Permissible values are: 1,2,4
b2w	Signed Integer (LSBF)	The binary value with all bits set to 1 must be used.	w specifies the number of Bytes used. Permissible values are: 1,2,4
b48	Signed Floating Point (LSBF)	The value for 'Not A Number' (NaN) must be used	according to IEC 559 or IEEE 754

\*) LSBF or "little-endian" is the byte order for multi-byte types. The least significant byte is placed closest to the beginning of a file.

### 10a-3.6 Data Descriptive Fields

Data Descriptive fields are fields of the Data Descriptive Record (DDR) of an ISO/IEC 8211 conformatal data file. These fields describe the format of each field in a Data record (DR) of such a file. A Data Descriptive field comprises the Field Control, the Data Field Name, the Array Descriptor, and the Format Controls. More details on Data Descriptive Fields are in ISO/IEC 8211 (1994) Clause 6.4.

Data Descriptive Fields contain non printable characters. In this document they are replaced with graphical symbols as the following table defines:

Character	Code	Graphic
Space	(2/0)	□
UT (Unit Terminator)	(1/15)	▲
FT (Field Terminator)	(1/14)	▼

The Data Descriptive Field is given in a bold text box following the table describing the format of the field.

## 10a-4 Common fields

### 10a-4.1 Attribute field

#### 10a-4.1.1 Encoding rules

In S-100 attributes can be either simple or complex. Simple attributes have values whereas complex attributes are an aggregation of other attributes, either simple or complex. The following diagram shows an example of a feature type with both simple and complex attributes.

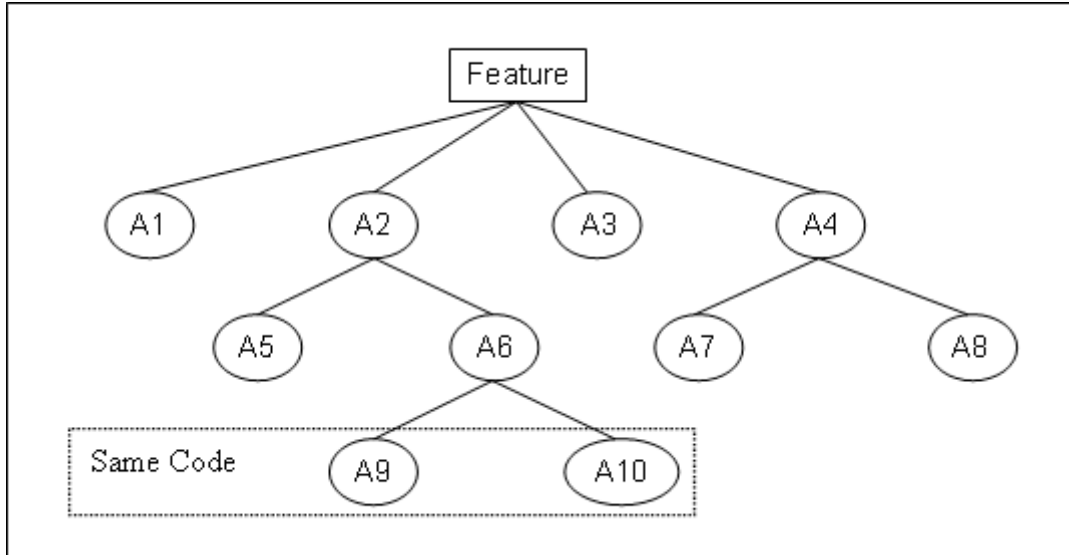


Figure 10a-2

The feature has four attributes: A1, A2, A3, and A4. A1 and A3 are simple attributes; A2 and A4 are complex attributes. A2 comprises two attributes (A5 and A6) where A5 is a simple one and A6 is another complex attribute. A4 and A6 are two complex attributes; both consist of two simple attributes.

Another characteristic of attributes is the cardinality. This indicates how many attributes of the same kind (the same code in a feature catalogue) are used at the same parent. The same parent means that they are all top level attributes or belonging to the same instance of a complex attribute. In the example above A9 and A10 are assumed to have the same code.

With the concept of cardinalities larger than one, an attribute can be seen as an array of attributes. To access an attribute in such an array one needs not only the code of that attribute but also the index of that attribute. Note that the order in such an array may be meaningful and must be maintained by the encoding.

Taking all of the above into account an attribute can be uniquely addressed by three values:

1. The attribute code
2. The index of the attribute (starting with 1)
3. The parent of the attribute

To complete the example above, the following table defines codes and values of the attributes:

Attribute	Code	Attribute Index	Value	Remarks
A1	21	1	Vachon	
A2	22	1		complex

A3	23	1	12	
A4	24	1		complex
A5	25	1	42.0	
A6	26	1		complex
A7	27	1	123	
A8	28	1	Canada	
A9	29	1	17	same code as A10
A10	29	2	43	same code as A9

To encode an attribute a set of five items is necessary: the three mentioned above plus an update instruction and the value of the attribute. To specify the parent of the attribute an index is used. This index points to the  $n^{\text{th}}$  tuple in the ATTR field starting with 1. The following table shows the encoding of the example:

Index	NATC	ATIX	PAIX	ATIN	ATVL	Remark
1	21	1	0	Insert	Vachon	A1
2	22	1	0	Insert		A2 - composite
3	25	1	2	Insert	42.0	A5
4	26	1	2	Insert		A6 - composite
5	29	1	4	Insert	17	A9
6	29	2	4	Insert	43	A10
7	23	1	0	Insert	12	A3
8	24	1	0	Insert		A4 - composite
9	27	1	8	Insert	123	A7
10	28	1	8	Insert	Canada	A8

Note that here the preorder traversing is used to define the order of tuples in the field. This keeps all part of a complex attribute together and guarantees that the parent is always stored before the child. The preorder traversing is defined as follows:

- 1) Encode the root
- 2) Than encode the sub-trees from left to right.

This traversing order is mandatory within this standard.

Note also that the ATIN subfield (Attribute update Instruction) will always be 'Insert' for encoding base data attributes. The other ATIN values (Modify, Delete) are only needed for updating the ATTR field.

All values of attribute are stored as character strings even if the value domain is a numeric type. UTF-8 will be the only encoding allowed in S-100 for such character strings. This allows the encoding of all characters of the first multilingual plane of ISO 10646. There is no other encoding for national character sets necessary.

#### 10a-4.2 Updating of the Attribute field

To update an attribute the attribute must be uniquely identifiable and once identified instructions are needed to affect that attribute. The Attribute Update Instruction indicates whether an attribute is to be deleted from the field; modified, or inserted. Deletion and modification implies that the attribute exists. Deletion and insertion may change the indices of other attributes in an array of attributes and therefore must be taken into account when the attribute field is updated. Instructions must be applied in sequence in order that the indices used are identifying the correct attributes components on subsequent updates.

To demonstrate the updating of attributes the example above should be modified as shown in the following figure.

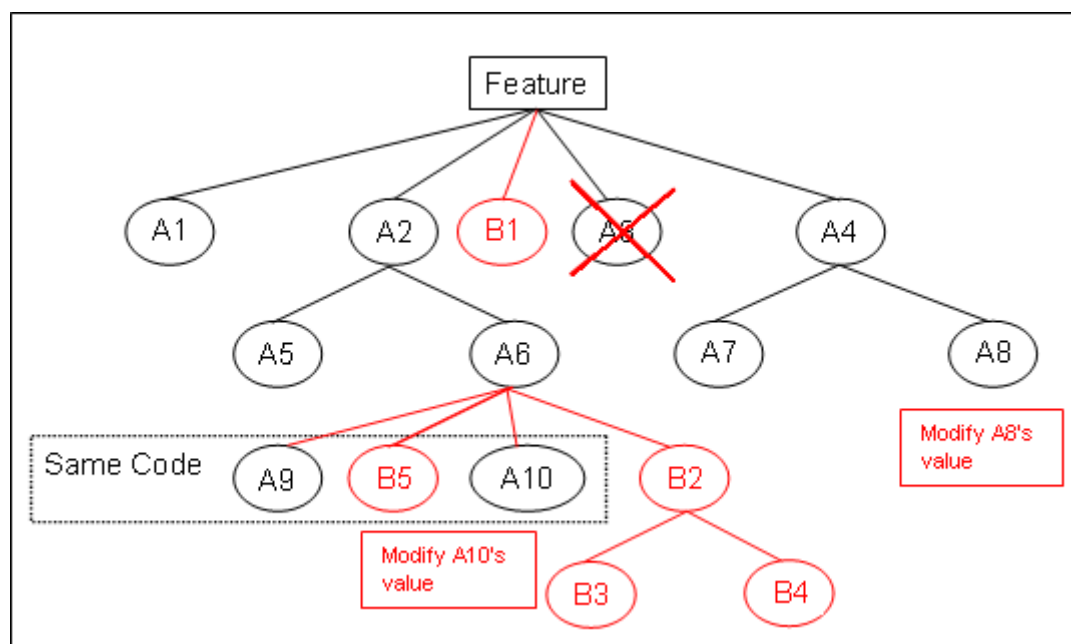


Figure 10a-3

The details are:

Attribute	Code	Attribute Index	Value	Update Instruction	Remarks
B5	29	2	32	Insert	Will change A10's index to 3
A10	29	3	7	Modify	
B2	35	1		Insert	complex
B3	36	1	32	Insert	
B4	37	1	123	Insert	
B1	32	1	abc	Insert	
A3	23	1	1,2	Delete	
A8	28	1	Germany	Modify	

In order to identify B5, A10 and B2 the entries for A2 and A6 must be inserted. The same is true for A4 (to identify A8). The complete field will look like:

Index	NATC	ATIX	PAIX	ATIN	ATVL	Remark
1	22	1	0	Modify		A2 - complex
2	26	1	1	Modify		A6 - complex
3	29	2	2	Insert	32	B5 - Will increase the ATIX of A10
4	29	3	2	Modify	7	A10 - now with ATIX 2
5	35	1	2	Insert		B2 - complex
6	36	1	5	Insert	22	B3
7	37	1	5	Insert	123	B4
8	32	1	0	Insert	abc	B1
9	23	1	0	Delete		A3
10	24	1	0	Modify		A4 - complex
11	28	1	10	Modify	Germany	A8

Note that in order to delete a complex attribute it will be adequate to delete the root entry of that attribute. E.g. to delete A2 only one entry (22, 1, 0, Delete) has to be encoded.

### 10a-4.3 Attribute field structure

Field Tag: <b>ATTR</b>	Field Name: Attribute
------------------------	-----------------------

Subfield name	Label	Format	Subfield content and specification
Numeric attribute code	*NATC	b12	A valid attribute code as defined in the ATCS field of the Dataset General Information Record
Attribute index	ATIX	b12	Index (position) of the attribute in the sequence of attributes with the same code and the same parent (starting with 1).
Parent index	PAIX	b12	Index (position) of the parent complex attribute within this ATTR field (starting with 1). If the attribute has no parent (top level attribute) the value is 0.
Attribute instruction	ATIN	b11	{1} - Insert {2} - Delete {3} - Modify
Attribute value	ATVL	A()	A string containing a valid value for the domain of the attribute specified by the subfields above.

#### Data Descriptive Field

2600; &%/GAttribute▲*NATC!ATIX!PAIX!ATIN!ATVL▲(3b12,b11,A)▼
---

### 10a-4.4 Information Association field

#### 10a-4.4.1 Encoding rules

An Information association is a link from one record to an information type record. An information type record can be referenced from any number of other records but at least one record should have an association to an information type record. Such associations will be encoded by means of the Information Association field (INAS). For each association a separate field has to be used. The association itself can have attributes. The attributes are encoded in the field by the same mechanism as described for the ATTR field. The same subfields are used at the end of the association field. Each association is uniquely addressed by the combination of the RRNM, RRID, IASS, and ROLE subfields.

The RRNM subfield is referencing the record name subfield (RCNM) and the RRID subfield is referencing the record id subfield (RCID) of the target record.

The Information Association Update Instruction INUI subfield is used to indicate if an association is to be inserted or deleted on update. For a base data set this field must have the value 'Insert'.

#### 10a-4.4.2 Information Association field structure

Field Tag: <b>INAS</b>	Field Name: Information Association
------------------------	-------------------------------------

Subfield name	Label	Format	Subfield content and specification
Referenced Record name	RRNM	b11	Record name of the referenced record
Referenced Record identifier	RRID	b14	Record identifier of the referenced record
Numeric Information Association Code	NIAC	b12	A valid code for the information association as defined in the IACS field of the Dataset General Information Record
Numeric AssociationRole code	NARC	b12	A valid code for the role as defined in the ARCS field of the Dataset General Information Record
Information Association Update Instruction	IUIN	b11	{1} - Insert {2} - Delete {3} - Modify
Numeric attribute code	*NATC	b12	A valid attribute code as defined in the ATCS field of the Dataset General Information Record
Attribute index	ATIX	b12	Index (position) of the attribute in the sequence of attributes

			with the same code and the same parent (starting with 1).
Parent index	PAIX	b12	Index (position) of the parent complex attribute within this INAS field (starting with 1). If the attribute has no parent (top level attribute) the value is 0.
Attribute Instruction	ATIN	b11	{1} - Insert {2} - Delete {3} - Modify
Attribute value	ATVL	A()	A string containing a valid value for the domain of the attribute specified by the subfields above.

### Data Descriptive Field

```
3600; &%/GInformation□Association▲RRNM!RRID!NIAC!NARC!IUIN\\*NATC!ATIX!PAIX
!ATIN!ATVL▲(b11,b14,2b12,b11,3b12,b11,A)▼
```

## 10a-5 Data Set Descriptive records

### 10a-5.1 Data Set General Information record

#### 10a-5.1.1 Encoding rules

This record encodes general information about the data set. This information includes identification, structural information and Metadata.

The Data Set Identification field contains information to identify the data set. This information is divided into three groups:

- 1) Information about the encoding
- 2) Information about the data product
- 3) Information about the data set itself

The first group specifies the encoding specification on which the encoding is based and what version of that specification is applicable.

The second group defines the data product, the edition of the product specification and the profile used within the product. The product itself is specified by a unique identifier. Edition and Profile depend on the product specification and will be encoded as character strings.

The third group contains:

- 1) A file identifier of the data set
- 2) A title of the data set
- 3) The reference (issue) date of the data set
- 4) The (default) language used in the data set
- 5) An abstract about the data set
- 6) The edition of the data set (may contain subversion/update number)
- 7) A list of topic categories according to ISO/IEC 19115 (see list)

Value of DSTC subfield	Topic Category
1	farming
2	biota
3	boundaries
4	climatologyMeterologyAtmosphere
5	economy
6	elevation
7	environment
8	geoscientificInformation
9	health

10	imageryBaseMapsEarthCover
11	intelligenceMilitary
12	inlandWaters
13	location
14	oceans
15	planningCadastre
16	society
17	structure
18	transportation
19	utilitiesCommunication

The Data Set Structure Information field contains some structural information. These are:

- 1) An origin offset used to shift the coordinate data being encoded such that higher precision can be carried in the region of the dataset.
- 2) The multiplication factors for the separate coordinate axes
- 3) The number of the different kinds of records in the data file

In an S-100 Feature catalogue all items are uniquely identifiable using the S100\_FC\_Item code which is a character string. This applies to Attributes, Information Types, Feature Types, Information Associations, Feature Associations and Association roles. In the interest of space and efficiency of the 8211 encoding it is desirable to use numeric identifiers for these items. To support this capability, the 8211 encoding includes a table for each item type that holds a listing of the S100\_FC\_Item codes used in the dataset. Each entry in the table carries the item code and the associated numeric code which will be used within the dataset everywhere that item type is referenced. These numeric codes are only guaranteed to be unique within one instance of a dataset. For example a Feature with code Coastline could be recorded in the Feature Type Codes field with a numeric code of 10. Then all the Coastline Features in the dataset would carry the numeric code of 10. In another dataset the numeric code for Coastline could be 15.

### 10a-5.1.2 Data Set General Information record structure

Data Set General Information record

```

|
|--DSID (13\\*1): Data Set Identification field
|
|--DSSI (13): Data Set Structure Information field
|
|<0..1>-ATCS (*2): Attribute Codes field
|
|<0..1>-ITCS (*2): Information Type Codes field
|
|<0..1>-FTCS (*2): Feature Type Codes field
|
|<0..1>-IACS (*2): Information Association Codes field
|
|<0..1>-FACS (*2): Feature Association Codes field
|
|<0..1>-ARCS (*2): Association Role Codes field

```

#### 10a-5.1.2.1 Data Set Identification field structure

Field Tag: <b>DSID</b>	Field Name: Data Set Identification
------------------------	-------------------------------------

Subfield name	Label	Format	Subfield content and specification
Record name	RCNM	b11	{10} - Data Set Identification
Record identification number	RCID	b14	Range: 1 to 2 <sup>32</sup> -2
Encoding specification	ENSP	A()	Encoding specification that defines the encoding
Encoding specification edition	ENED	A()	Edition of the encoding specification
Product identifier	PRSP	A()	Unique identifier for the data product as specified in the product specification
Product edition	PRED	A()	Edition of the product specification
Application profile	PROF	A()	Identifier that specifies a profile within the data product
Dataset file identifier	DSNM	A()	The file identifier of the dataset
Dataset title	DSTL	A()	The title of the dataset
Dataset reference date	DSRD	A(8)	The reference date of the dataset Format: YYYYMMDD according to ISO 8601
Dataset language	DSLGL	A()	The (primary) language used in this dataset
Dataset abstract	DSAB	A()	The abstract of the dataset
Dataset edition	DSED	A()	The edition of the dataset
Dataset topic category	*DSTC	b11	A set of topic categories

### Data Descriptive Field

```
3600; &%/GData□Set□Identification▲RCNM!RCID!ENSP!ENED!PRSP!PRED!PROF!DSNM!DSTL!DSRD!DSLGL!DSAB!DSED\\*DSTC▲(b11,b14,7A,A(8),3A,b11)▼
```

### 10a-5.1.2.2 Data Set Structure Information field structure

Field Tag: <b>DSSI</b>	Field Name: Data Set Structure Information
------------------------	--

Subfield name	Label	Format	Subfield content and specification
Dataset Coordinate Origin X	DCOX	b48	Shift used to adjust x-coordinate before encoding
Dataset Coordinate Origin Y	DCOY	b48	Shift used to adjust y-coordinate before encoding
Dataset Coordinate Origin Z	DCOZ	b48	Shift used to adjust z-coordinate before encoding
Coordinate multiplication factor for x-coordinate	CMFX	b14	Floating point to integer multiplication factor for the x-coordinate or longitude
Coordinate multiplication factor for y-coordinate	CMFY	b14	Floating point to integer multiplication factor for the y-coordinate or latitude
Coordinate multiplication factor for z-coordinate	CMFZ	b14	Floating point to integer multiplication factor for the z-coordinate or depths or height
Number of Information Type records	NOIR	b14	Number of information records in the data set
Number of Point records	NOPN	b14	Number of point records in the data set
Number of Multi Point records	NOMN	b14	Number of multi point records in the data set
Number of Curve records	NOCN	b14	Number of curve records in the data set
Number of Composite Curve records	NOXN	b14	Number of composite curve records in the data set
Number of Surface records	NOSN	b14	Number of surface records in the data set
Number of Feature Type records	NOFR	b14	Number of feature records in the data set

### Data Descriptive Field

```
1600; &□□□Data□Set□Structure□Information▲DCOX!DCOY!DCOZ!CMFX!CMFY!CMFZ!NOIR!NOPM!NOMN!NOCN!NOXN!NOSN!NOFR▲(3b48,10b14)▼
```

### 10a-5.1.2.3 Attribute Codes field structure

Field Tag: <b>ATCS</b>	Field Name: Attribute Codes
------------------------	-----------------------------



Subfield name	Label	Format	Subfield content and specification
Attribute Code	ATCD	A	The code as defined in the feature catalogue
Attribute Numeric Code	ANCD	b12	The code used within the NATC subfield

### Data Descriptive Field

2600; &□□□Attribute□Codes▲\*ATCD!ANCD▲(A, b12) ▼

### 10a-5.1.2.4 Information Type Codes field structure

Field Tag: <b>ITCS</b>	Field Name: Information Type Codes
------------------------	------------------------------------

Subfield name	Label	Format	Subfield content and specification
Information Type Code	ITCD	A	The code as defined in the feature catalogue
Information Type Numeric Code	ITNC	b12	The code used within the NITC subfield

### Data Descriptive Field

2600; &□□□Information□Type□Codes▲\*ITCD!ITNC▲(A, b12) ▼

### 10a-5.1.2.5 Feature Type Codes field structure

Field Tag: <b>FTCS</b>	Field Name: Feature Type Codes
------------------------	--------------------------------

Subfield name	Label	Format	Subfield content and specification
Feature Type Code	FTCD	A	The code as defined in the feature catalogue
Feature Type Numeric Code	FTNC	b12	The code used within the NFTC subfield

### Data Descriptive Field

2600; &□□□Feature□Type□Codes▲\*FTCD!FTNC▲(A, b12) ▼

### 10a-5.1.2.6 Information Association Codes field structure

Field Tag: <b>IACS</b>	Field Name: Information Association Codes
------------------------	---

Subfield name	Label	Format	Subfield content and specification
Information Association Code	IACD	A	The code as defined in the feature catalogue
Information Association Numeric Code	IANC	b12	The code used within the NIAC subfield

### Data Descriptive Field

2600; &□□□Information□Association□Codes▲\*IACD!IANC▲(A, b12) ▼

### 10a-5.1.2.7 Feature Association Codes field structure

Field Tag: <b>FACS</b>	Field Name: Feature Association Codes
------------------------	---------------------------------------

Subfield name	Label	Format	Subfield content and specification
Feature Association Code	FACD	A	The code as defined in the feature catalogue
Feature Association Numeric Code	FANC	b12	The code used within the NFAC subfield

### Data Descriptive Field

```
2600; &[ ] [ ] Feature [ ] Association [ ] Codes▲*FACD!FANC▲(A, b12)▼
```

### 10a-5.1.2.8 Association Role Codes field structure

Field Tag: <b>ARCS</b>	Field Name: Association Role Codes
------------------------	------------------------------------

Subfield name	Label	Format	Subfield content and specification
Association Role Code	ARCD	A	The code as defined in the feature catalogue
Association Role Numeric Code	ARNC	b12	The code used within the NARC subfield

### Data Descriptive Field

```
2600; &[ ] [ ] Association [ ] Role [ ] Codes▲*ARCD!ARNC▲(A, b12)▼
```

## 10a-5.2 Data Set Coordinate Reference System record

### 10a-5.2.1 Encoding rules

All two-dimensional coordinates in a dataset refer to one horizontal CRS. Three-dimensional coordinates refer to a compound CRS which consists of the horizontal CRS and a vertical CRS. There can be more than one vertical CRSs in a dataset one for each compound CRS.

The CRSH field contains the following information about the (single) CRS.

- The type of CRS (this implies the dimension of the coordinate system)
- The type of the associated coordinate system
- The name of the CRS
- An identifier in an external source (if the CRS is defined by referencing)
- An indication which external source is referenced
- Information about this source (if it is not one from a predefined list)

If the CRS is not defined by referencing all details of the coordinate axes, the datum and if necessary about the used projection must be encoded. This has to done by means of the appropriate fields. In this case the CRSI subfield must be encoded empty and the CRSS subfield must have the value 255 (Not Applicable).

For more details on CRS refer to the Coordinate Reference System Component of this standard.

This encoding specification supports the following types of CRS's:

CRS Type	Dimension	CS Type	Axes	Type of Datum	CRST value	Remarks
2D Geographic	2	Ellipsoidal	Geodetic Latitude Geodetic Longitude	Geodetic	1	can combined with a vertical CRS
3D Geographic	3	Ellipsoidal	Geodetic Latitude Geodetic Longitude Ellipsoidal Height	Geodetic	2	
Geocentric	3	Cartesian	Geocentric X Geocentric Y Geocentric Z	Geodetic	3	
Projected	2	Cartesian	Easting / Westing Northing / Southing	Geodetic	4	can combined with a vertical CRS
Vertical	1	Vertical	Gravity Related Height or Gravity related Depth	Vertical	5	

The next table shows the supported coordinate axes.

Axis Type	Axis direction	AXTY value	Remarks
Geodetic Latitude	North	1	
Geodetic Longitude	East	2	
Ellipsoidal Height	Up	3	
Easting	East	4	
Northing	North	5	
Westing	West	6	
Southing	South	7	
Geocentric X	Geocentric X	8	
Geocentric Y	Geocentric Y	9	
Geocentric Z	Geocentric Z	10	
Gravity Related Height	Up	11	
Gravity Related Depth	Down	12	

This table shows the supported projections together with their set of parameters

Name	PROM value	Parameter 1	Parameter 2	Parameter 3	Parameter 4	Parameter 5	EPSG code
Mercator	1	Latitude of 1 <sup>st</sup> standard parallel <sup>1)</sup>	Longitude of natural origin	-	-	-	9805
Transverse Mercator	2	Latitude of natural origin	Longitude of natural origin	Scale factor at natural origin	-	-	9807
Oblique Mercator	3	Latitude of projection centre	Longitude of projection centre	Azimuth of initial line	Angle from Rectified to Skew Grid	Scale factor on initial line	9815
Hotine Oblique Mercator	4	Latitude of projection centre	Longitude of projection centre	Azimuth of initial line	Angle from Rectified to Skew Grid	Scale factor on initial line	9812
Lambert Conic Conformal (1SP)	5	Latitude of natural origin	Longitude of natural origin	Scale factor at natural origin	-	-	9801
Lambert Conic Conformal (2SP)	6	Latitude of false origin	Longitude of false origin	Latitude of 1 <sup>st</sup> standard	Latitude of 2 <sup>nd</sup> standard	-	9802

Name	PROM value	Parameter 1	Parameter 2	Parameter 3	Parameter 4	Parameter 5	EPSG code
				parallel <sup>2)</sup>	parallel <sup>3)</sup>		
Oblique Stereographic	7	Latitude of natural origin	Longitude of natural origin	Scale factor at natural origin	-	-	9809
Polar Stereographic	8	Latitude of natural origin <sup>4)</sup>	Longitude of natural origin	Scale factor at natural origin	-	-	9810
Krovak Oblique Conic Conformal	9	Latitude of projection centre	Longitude of projection centre	Azimuth of initial line	Latitude of pseudo standard parallel	Scale factor on pseudo standard parallel	9819
American Polyconic	10	Latitude of natural origin	Longitude of natural origin	-	-	-	9818
Albers Equal Area	11	Latitude of false origin	Longitude of false origin	Latitude of 1 <sup>st</sup> standard parallel <sup>2)</sup>	Latitude of 2 <sup>nd</sup> standard parallel <sup>3)</sup>	-	9822
Lambert Azimuthal Equal Area	12	Latitude of natural origin	Longitude of natural origin	-	-	-	9820
New Zealand Mapgrid	13	Latitude of natural origin	Longitude of natural origin	-	-	-	9811

<sup>1)</sup> Latitude of true scale

<sup>2)</sup> Standard parallel nearer to equator

<sup>3)</sup> Standard parallel farther from equator

<sup>4)</sup> Must be either 90 degrees or -90 degrees

All latitudes and longitudes must be given in degrees (south and west are negative). Azimuths are given in degrees. For the detailed formulas of the projections refer to the EPSG documentation.

In case that both two-dimensional and three-dimensional coordinates are used in the same data set the three-dimensional coordinates must be described by a compound CRS. The two-dimensional coordinates refer to the first component (usually a 2D Geographic or Projected CRS).

Although all coordinates in a data set must refer to the same CRS different Vertical Datums can be used for the height or depth component of a coordinate tuple. Therefore the VDAT field can be repeated. For each Vertical Datum a unique identifier is defined. Those identifiers will be used in the 3D - coordinate fields to indicate which Vertical Datum is used. The encoding of the Coordinate Reference System record will be demonstrated with two examples. The first example specifies a compound CRS. The first component is a 2D Geographic CRS (WGS84) and the second component is a Vertical CRS for depth using the Vertical Datum: Mean Sea Level.

```

CSID: RCNM{15}!RCID{1}!NCRC{2}!
CRSH: CRIX{1}!CRST{1}!CSTY{1}!CRNM'WGS
      84'!CRSI'4326'!CRSS{2}!SCRI!
CRSH: CRIX{2}!CRST{5}!CSTY{3}!CRNM'Mean Sea Level Depth'!
      CRSI!CRSS{255}SCRI!
CSAX: AXTY{12}!AXUM{4}!
VDAT: DTNM'Mean Sea Level'!DTID'VERDAT3'!DTSR{2}!SCRI!

```

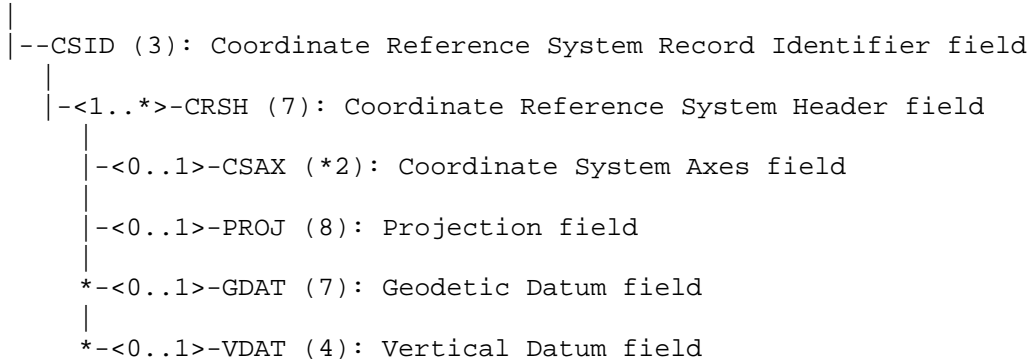
The second example encodes a projected CRS by defining the details.

```

CSID: RCNM{15}!RCID{1}!NCRS{1}!
CRSH: CRIX{1}!CRST{4}!CSTY{2}!CRNM'WGS84/UTM
        32N'!CRSI!CRSS{255}SCRI!
CSAX: AXTY{4}!AXUM{4}!AXTY{5}!AXUM{4}!
PROJ: PROM{2}!PRP1{0}!PRP2{9}!PRP3{0.9996}!PRP4{0}!PRP5{0}!
        FEAS{500000}!FNOR{0}!
GDAT: DTNM'World Geodetic System 1984'!ELNM'WGS 84'!ESMA{6378137}!
        ESPT{2}!ESPM{298.257223563}!CMNM'Greenwich'!CMGL{0}!
    
```

**10a-5.2.2 Data Set Coordinate Reference System record structure**

Data Set Coordinate Reference System record



**10a-5.2.2.1 Coordinate Reference System Record Identifier field structure**

Field Tag: <b>CSID</b>	Field Name: Coordinate Reference System Record Identifier
------------------------	---

Subfield name	Label	Format	Subfield content and specification
Record name	RCNM	b11	{15} - Coordinate Reference System Identifier
Record identification number	RCID	b14	Range: 1 to 2 <sup>32</sup> -2
Number of CRS Components	NCRS	b11	

**Data Descriptive Field**

```

1100; &[] [] [] Coordinate[] Reference[] System[] Record[] Identifier▲RCNM!RCID!NCRS▲(b11, b14, b11)▼
    
```

**10a-5.2.2.2 Coordinate Reference System Header field structure**

Field Tag: <b>CRSH</b>	Field Name: Coordinate Reference System Header
------------------------	--

Subfield name	Label	Format	Subfield content and specification
CRS Index	CRIX	b11	Internal identifier of the CRS (Used for identifying the vertical CRS in C3DI or C3DF)
CRS Type	CRST	b11	see table
Coordinate System Type	CSTY	b11	{1} - Ellipsoidal CS {2} - Cartesian CS {3} - Vertical CS
CRS Name	CRNM	A()	Name of the Coordinate Reference System
CRS Identifier	CRSI	A()	Identifier of the CRS from an external source. Empty if not defined by reference
CRS Source	CRSS	b11	{1} - IHO CRS Register {2} - EPSG

			{254} - Other Source {255} - Not Applicable
CRS Source Information	SCRI	A()	Information about the CRS source if CRSS = 'Other Source'

### Data Descriptive Field

```
1600; &%/GCoordinate□Reference□System□Header▲CRIX!CRST!CSTY!CRNM!CRSI!CRSS!
SRCI▲(3b11, 2A, b11, A)▼
```

### 10a-5.2.2.3 Coordinate System Axes field structure

Field Tag: <b>CSAX</b>	Field Name: Coordinate System Axes
------------------------	------------------------------------

Subfield name	Label	Format	Subfield content and specification
Axis Type	*AXTY	b11	see table
Axis Unit of Measure	AXUM	b11	{1} - Degree {2} - Grad {3} - Radian {4} - Metre {5} - International foot {6} - US survey foot

### Data Descriptive Field

```
2100; &□□□Coordinate□System□Axes▲*AXTY!AXUM▲(2b11)▼
```

### 10a-5.2.2.4 Projection field structure

Field Tag: <b>PROJ</b>	Field Name: Projection
------------------------	------------------------

Subfield name	Label	Format	Subfield content and specification
Projection Method	PROM	b11	see table
Projection Parameter 1	PRP1	b48	see table
Projection Parameter 2	PRP2	b48	see table
Projection Parameter 3	PRP3	b48	see table
Projection Parameter 4	PRP4	b48	see table
Projection Parameter 5	PRO5	b48	see table
False Easting	FEAS	b48	False easting (Units of measurement according to the coordinate axis 'Easting')
False Northing	FNOR	b48	False northing (Units of measurement according to the coordinate axis 'Northing')

### Data Descriptive Field

```
1600; &□□□Projection▲PROM!PRP1!PRP2!PRP3!PRP4!PRP5!FEAS!FNOR!▲(b11, 7b48)▼
```

### 10a-5.2.2.5 Geodetic Datum field structure

Field Tag: <b>GDAT</b>	Field Name: Geodetic Datum
------------------------	----------------------------

Subfield name	Label	Format	Subfield content and specification
Datum Name	DTNM	A()	Name of the geodetic datum
Ellipsoid Name	ELNM	A()	Name of the ellipsoid
Ellipsoid semi major axis	ESMA	b48	Semi major axis of the ellipsoid in metre
Ellipsoid second parameter type	ESPT	b11	{1} - Semi minor axis in metres {2} - Inverse Flattening
Ellipsoid second parameter	ESPM	b48	The second defining parameter of the ellipsoid
Central Meridian Name	CMNM	A()	Name of the central meridian
Central Meridian Greenwich Longitude	CMGL	b48	Greenwich longitude of the central meridian in degrees

#### Data Descriptive Field

```
1600; &%/GGeodetic□Datum▲DTNM!ELNM!ESMA!ESPT!ESPM!CMNM!CMGL!▲(2A, b48, b11, b48, A, b48)▼
```

### 10a-5.2.2.6 Vertical Datum field structure

Field Tag: <b>VDAT</b>	Field Name: Vertical Datum
------------------------	----------------------------

Subfield name	Label	Format	Subfield content and specification
Datum Name	DTNM	A()	Name of the Vertical datum
Datum Identifier	DTID	A()	Identifier of the datum in an external source
Datum Source	DTSR	b11	{1} - IHO CRS Register {2} - Feature Catalogue {3} - EPSG {254} - Other Source {255} - Not Applicable
Datum Source Information	SCRI	A()	Information about the CRS source if DTSR = 'Other Source'

#### Data Descriptive Field

```
1600; &%/GVertical□Datum▲DTNM!DTID!DTSR!SCRI!▲(2A, b11, A)▼
```

## 10a-5.3 Information Type record

### 10a-5.3.1 Encoding rules

Information types are pieces of information in a data set that can be shared between objects. They have attributes like feature types but are not related to any geometry. Information types may reference other information types. For this encoding it is important that an information type record must be stored prior to any record that references this record.

The object code must be a valid code in the feature catalogue that is defined for the data product. The record version will be initialized with 1 and will be incremented for any update of this record. The record update instruction indicates if an information type will be inserted, modified or deleted in an update. In a base data set the value will always be 'Insert'.

### 10a-5.3.2 Information Type record structure

Information Type record

```

|
|--IRID (5): Information Type Record Identifier field
|
|  |--<0..*>-ATTR (*5): Attribute field
|  |
|  |--<0..*>-INAS (5\\*5): Information Association field

```

### 10a-5.3.3 Information Type Identifier field structure

Field Tag: IRID	Field Name: Information Type Record Identifier
-----------------	--

Subfield name	Label	Format	Subfield content and specification
Record name	RCNM	b11	{150} - Information Type
Record identification number	RCID	b14	Range: 1 to 2 <sup>32</sup> -2
Numeric Information Type Code	NITC	b12	A valid information type code as defined in the ITCS field of the Dataset General Information Record
Record version	RVER	b12	RVER contains the serial number of the record edition
Record update instruction	RUIN	b11	{1} - Insert {2} - Delete {3} - Modify

#### Data Descriptive Field

```

1100; &[ ][ ][ ]Information[ ]Type[ ]Record[ ]Identifier▲RCNM!RCID!NITC!RVER!RUIN▲(b11,
b14, 2b12, b11)▼

```

## 10a-5.4 Spatial type records

### 10a-5.4.1 Coordinates

#### 10a-5.4.1.1 Encoding rules

Coordinates in a dataset are defined by the coordinate reference system (CRS). The CRS is defined in the Coordinate Reference System record. This record also defines the units of the coordinates.

The DSSI field of the Data Set General Information record can carry a local origin for the coordinates in a Data Set. When storing coordinates the Origin needs to be subtracted from the value, when reading coordinates from a dataset the Origin needs to be added back on to restore the CRS defined value.

Coordinates can be stored in two ways as floating point numbers or as integer numbers. In the latter case the stored integer value is calculated by the multiplication of the real coordinate and a multiplication factor. Those factors are defined for each coordinate axis in the DSSI field of the Data Set General Information record. With these factors the stored value can be transformed into the real coordinate according to the coordinate reference system (CRS).

The coordinates are transformed as follows:

$$\begin{aligned}
 x &= DCOX + XCOO / CMFX \\
 y &= DCOY + YCOO / CMFY \\
 z &= DCOZ + ZCOO / CMFZ
 \end{aligned}$$

Note that the values of (CMFX, CMFY and CMFZ) should be set to 1 if the coordinates are stored as floating point values.



If the coordinate field allows more than one coordinate tuple the update must maintain the order of the coordinates. Each update of a coordinate stream is therefore defined by an index into the coordinate field(s) of the target record, an update instruction and the number of coordinates in the coordinate field(s) of the update record.

Note that the index and the number refer to coordinate tuples, not to single coordinates. The index will start with 1.

#### 10a-5.4.1.2 Coordinate Control field structure

Field Tag: <b>COCC</b>	[Upd]	Field Name: Coordinate Control
------------------------	-------	--------------------------------

Subfield name	Label	Format	Subfield content and specification
Coordinate Update Instruction	COUI	b11	{1} - Insert {2} - Delete {3} - Modify
Coordinate Index	COIX	b12	Index (position) of the addressed coordinate tuple within the coordinate field(s) of the target record
Number of Coordinates	NCOR	b12	Number of coordinate tuples in the coordinate field(s) of the update record

#### Data Descriptive Field

1100; &□□□Coordinate□Control▲COUI!COIX!NCOR▲(b11, 2b12) ▼
---

#### 10a-5.4.2 2-D Integer Coordinate Tuple field structure

Field Tag: <b>C2IT</b>	Field Name 2-D Integer Coordinate Tuple
------------------------	---

Subfield name	Label	Format	Subfield content and specification
Coordinate in Y axis	YCOO	b24	Y-coordinate or latitude
Coordinate in X axis	XCOO	b24	X-coordinate or longitude

#### Data Descriptive Field

2100; &□□□2-D□Integer□Coordinate□Tuple▲YCOO!XCOO▲(2b24) ▼
---

#### 10a-5.4.3 3-D Integer Coordinate Tuple field structure

Field Tag: <b>C3IT</b>	Field Name: 3-D Integer Coordinate Tuple
------------------------	--

Subfield name	Label	Format	Subfield content and specification
Vertical CRS Id	VCID	b11	Internal identifier of the Vertical CRS
Coordinate in Y axis	YCOO	b24	Y- coordinate or latitude
Coordinate in X axis	XCOO	b24	X- coordinate or longitude
Coordinate in Z axis	ZCOO	b24	Z - coordinate (depth or height)

#### Data Descriptive Field

3100; &□□□3-D□Integer□Coordinate□Tuple▲VCID!YCOO!XCOO!ZCOO▲(b11, 3b24) ▼
--

**10a-5.4.4 2-D Floating Point Coordinate Tuple field structure**

Field Tag: <b>C2FT</b>	Field Name 2-D Floating Point Coordinate Tuple
------------------------	--

Subfield name	Label	Format	Subfield content and specification
Coordinate in Y axis	YCOO	b48	Y-coordinate or latitude
Coordinate in X axis	XCOO	b48	X-coordinate or longitude

**Data Descriptive Field**

2200; &[ ]2-D Floating Point Coordinate Tuple▲YCOO!XCOO▲(2b48)▼
---

**10a-5.4.5 3-D Floating Point Coordinate Tuple field structure**

Field Tag: <b>C3FT</b>	Field Name: 3-D Floating Point Coordinate Tuple
------------------------	---

Subfield name	Label	Format	Subfield content and specification
Vertical CRS Id	VCID	b11	Internal identifier of the Vertical CRS
Coordinate in Y axis	YCOO	b48	Y- coordinate or latitude
Coordinate in X axis	XCOO	b48	X- coordinate or longitude
Coordinate in Z axis	ZCOO	b48	Z - coordinate (depth or height)

**Data Descriptive Field**

3600; &[ ]3-D Floating Point Coordinate Tuple▲VCID!YCOO!XCOO!ZCOO▲(b11, 3b48)▼
--

**10a-5.4.6 2-D Integer Coordinate List field structure**

Field Tag: <b>C2IL</b>	Field Name 2-D Integer Coordinate List
------------------------	--

Subfield name	Label	Format	Subfield content and specification
Coordinate in Y axis	*YCOO	b24	Y-coordinate or latitude
Coordinate in X axis	XCOO	b24	X-coordinate or longitude

**Data Descriptive Field**

2100; &[ ]2-D Integer Coordinate List▲*YCOO!XCOO▲(2b24)▼
--

**10a-5.4.7 3-D Integer Coordinate List field structure**

Field Tag: <b>C3IL</b>	Field Name: 3-D Integer Coordinate List
------------------------	---

Subfield name	Label	Format	Subfield content and specification
Vertical CRS Id	VCID	b11	Internal identifier of the Vertical CRS
Coordinate in Y axis	*YCOO	b24	Y- coordinate or latitude
Coordinate in X axis	XCOO	b24	X- coordinate or longitude
Coordinate in Z axis	ZCOO	b24	Z - coordinate (depth or height)

**Data Descriptive Field**

3100; &[ ]3-D Integer Coordinate List▲VCID\*YCOO!XCOO!ZCOO▲(b11, 3b24)▼
---

### 10a-5.4.8 2-D Floating Point Coordinate List field structure

Field Tag: <b>C2FL</b>	Field Name 2-D Floating Point Coordinate List
------------------------	---

Subfield name	Label	Format	Subfield content and specification
Coordinate in Y axis	*YCOO	b48	Y-coordinate or latitude
Coordinate in X axis	XCOO	b48	X-coordinate or longitude

#### Data Descriptive Field

2200; &[ ] [ ] 2-D Floating Point Coordinate List▲*YCOO!XCOO▲(2b48)▼
--

### 10a-5.4.9 3-D Floating Point Coordinate List field structure

Field Tag: <b>C3FL</b>	Field Name: 3-D Floating Point Coordinate List
------------------------	--

Subfield name	Label	Format	Subfield content and specification
Vertical CRS Id	VCID	b11	Internal identifier of the Vertical CRS
Coordinate in Y axis	*YCOO	b48	Y- coordinate or latitude
Coordinate in X axis	XCOO	b48	X- coordinate or longitude
Coordinate in Z axis	ZCOO	b48	Z - coordinate (depth or height)

#### Data Descriptive Field

3600; &[ ] [ ] 3-D Floating Coordinate List▲VCID\ *YCOO!XCOO!ZCOO▲(b11, 3b24)▼
--

## 10a-5.5 Point record

### 10a-5.5.1 Encoding rules

A point is a zero-dimensional spatial object. It will be encoded with the Point record. This record contains the Point Record Identifier field. With the RCNM and RCID subfields every point must be uniquely identifiable within a data set. A point can have attributes and associations to information types.

Each point has exactly one coordinate field with exactly one coordinate tuple. Points can have both 2D or 3D coordinates.

Since there is only one coordinate tuple no special mechanism is necessary to address a coordinate for updating. When the coordinate of a point is to be updated the update record will contain a coordinate field with the new coordinate. The dimension of the coordinate in the update record must be the same as in the target record.

### 10a-5.5.2 Point record structure

Point record

```

|
|--PRID (4): Point Record Identifier field
|
|  -<0..*>-INAS (5\\*5): Information Association field
|
|  alternate coordinate representations
|
*--C2IT (2): 2-D Integer Coordinate Tuple field
|
*--C3IT (4): 3-D Integer Coordinate Tuple field
|
*--C2FT (2): 2-D Floating Point Coordinate Tuple field
|
*--C3FT (4): 3-D Floating Point Coordinate Tuple field

```

#### 10a-5.5.2.1 Point Record Identifier field structure

Field Tag: <b>PRID</b>	Field Name: Point Record Identifier
------------------------	-------------------------------------

Subfield name	Label	Format	Subfield content and specification
Record name	RCNM	b11	{110} - Point
Record identification number	RCID	b14	Range: 1 to $2^{32}-2$
Record version	RVER	b12	RVER contains the serial number of the record edition
Record update instruction	RUIN	b11	{1} - Insert {2} - Delete {3} - Modify

#### Data Descriptive Field

```
1100; &□□□Point□Record□Identifier▲RCNM!RCID!RVER!RUIN▲(b11,b14,b12,b11)▼
```

### 10a-5.6 Multi Point record

#### 10a-5.6.1 Encoding rules

A Multi Point is an aggregation of zero-dimensional spatial objects. It will be encoded with the Multi Point record. Each Multi Point must have a unique identifier (RCNM + RCID) stored in the Multi Point Record Identifier field. Like any other spatial object Multi Points can have attributes and associations to information types.

Coordinates will be stored by one type of the coordinate list fields. The field can be repeated and in one field can be multiple coordinate tuples. If multiple coordinate list fields are used they must be all of the same type. If 3D-coordinates are used for the Multi Point they must all refer to the same Vertical Datum.

On updating the Coordinate control field defines which coordinates in the target record will be updated. Three kinds of updates are possible as defined by the Coordinate Update Instruction subfield (COUI):

1) Insert

Coordinates encoded in the coordinate field(s) of the update record must be inserted in the coordinate field(s) of the target record. The Coordinate Index subfield (COIX) indicates the index where the new coordinates are to be inserted. The first coordinate has the index 1. The number of coordinates to be inserted is given in the Number of Coordinates subfield (NCOR).

- 2) Delete  
Coordinates must be deleted from the coordinate field(s) of the target record. The deletion must start at the index specified in the COIX subfield. The number of coordinates to be removed is given in the NCOR subfield.
- 3) Modify  
Coordinates encoded in the coordinate field(s) of the update record must replace the addressed coordinate(s) in the coordinate field(s) of the target record. The replacement must start at the index given in the COIX subfield. The number of coordinates to be replaced is given in the NCOR subfield.

Note that the index and number as given in the COIX and NCOR subfields are regarded to coordinate tuples not to single coordinates.

If several operations are necessary to update the coordinates of one target record each operation shall be encoded in a separate update record. Note that indices always refer to the latest version of the record i.e. if the indices of coordinates have changed by one update record these changes have to be taken into account in every subsequent update record.

All coordinates in an update record must be stored in the same type of Coordinate field that is used in the target record and for 3D-coordinates the must refer to the same Vertical Datum as the coordinates in the target record.

### 10a-5.6.2 Multi Point record structure

Multi Point record

```

|
|--MRID (4): Multi Point Record Identifier field
|
|  |--<0..*>-INAS (5\\*5): Information Association field
|  |
|  |--<0..1>-COCC (3): Coordinate Control field
|  |
|  |alternate coordinate representations
|  |
|  |--<0..*>-C2IL (*2): 2-D Integer Coordinate List field
|  |
|  |--<0..*>-C3IL (1\\*3): 3-D Integer Coordinate List field
|  |
|  |--<0..*>-C2FL (*2): 2-D Floating Point Coordinate List field
|  |
|  |--<0..*>-C3FL (1\\*3): 3-D Floating Point Coordinate List field

```

#### 10a-5.6.2.1 Multi Point Record Identifier field structure

Field Tag: <b>MRID</b>	Field Name: Multi Point Record Identifier		
Subfield name	Label	Format	Subfield content and specification
Record name	RCNM	b11	{115} - Multi Point
Record identification number	RCID	b14	Range: 1 to $2^{32}-2$
Record version	RVER	b12	RVER contains the serial number of the record edition
Record update instruction	RUIN	b11	{1} - Insert {2} - Delete {3} - Modify

## Data Descriptive Field

```
1100; &□□□Multi□Point□Record□Identifier▲RCNM!RCID!RVER!RUIN▲(b11,b14,b12,b11)▼
```

### 10a-5.7 Curve record

#### 10a-5.7.1 Encoding rules

A Curve is a one-dimensional spatial object. It consists of one or more segments which define the geometry of the curve. All segments of one curve define one contiguous path. The geometry of a segment is given by a set of control points (coordinates) and an interpolation method. As with any other spatial object, curves can have attributes and associations to information types. A curve can have associations to points which define the topological boundaries (the ends) of the curve. Those points must be coincident with the start of the first segment or with the end of the latest segment respectively. The association with such points will be encoded by means of the Point Association field (PTAS).

For each segment, one Segment Header field (SEGH) has to be encoded followed by the Coordinate Control field (update records only) and Coordinate fields. For segments with the INTP subfield set to 7 (CircularArcCenterPointWithRadius) a parameter field (CIPM or ARPM) must follow the Coordinate field to define the additional parameter of such segments. The CIPM (Circle Parameter field) must be used if the segment is a full circle and the ARPM (Arc Parameter field) must be used for circular arcs. Note that for such segments there is exactly one control point.

Coordinates of control points can be stored in the following fields: C2IL, C2FL, C3IL, or C3FL. Those fields, coordinate list fields, can be repeated and can carry multiple coordinate tuples (except for INTP equal to 7 see above).

If multiple coordinate list fields are used they must be all of the same type. If 3D-coordinates are used for the segment they must all refer to the same Vertical Datum.

For the Point Association field no special update instruction is needed. The association defined in the update record will replace the respective association in the target record.

For segments the order is important and must be maintained during the update. Therefore a special control field for segments will be used during update. The order of segments in a curve is defined by the sequence of Segment Header fields in the record. To update this sequence the Segment Control field (SECC) is used.

Three instructions can be defined in the SEUI subfield:

- 1) Insert  
Segments of the update record has to be inserted into the target record. The SEIX subfield specifies the index (position) where the segments are to be inserted. The subfield NSEG subfield gives the number of segments to be inserted.
- 2) Delete  
Segments must be deleted from the target record. The subfields SEIX and NSEG specify where and how many segments are to be deleted.
- 3) Modify  
Segments of the target record must be modified according to the encoded instructions in the update record. Each segment that is to be modified must have at a Segment Header filed, a Coordinate Control field and if necessary the appropriate Coordinate fields. The SEIX subfield indicates the first segment to be modified and the NSEG subfield gives the number of segments to be modified. All segments to be modified with one update record must be contiguous in the target record. Otherwise more than one update record has to be used.

When the coordinates of the control points of a segment are to be modified, this has to be done by means of the Coordinate Control field. It defines which coordinates in the target

record will be updated. Three kinds of updates are possible and are defined by the Coordinate Update Instruction subfield (COUI):

- 1) Insert  
Coordinates encoded at the coordinate field(s) of the update records segment must be inserted in the coordinate field(s) of the corresponding target records segment. The Coordinate Index subfield (COIX) indicates the index where the new coordinates are inserted. The first coordinate has the index 1. The number of coordinates to be inserted is given in the Number of Coordinates subfield (NCOR).
- 2) Delete  
Coordinates must be deleted from the coordinate field(s) of the corresponding target records segment. The deletion must start at the index specified in the COIX subfield. The number of coordinates to be removed is given in the NCOR subfield.
- 3) Modify  
Coordinates encoded in the coordinate field(s) of the update records segment must be replace the addressed coordinate(s) in the coordinate field(s) of the corresponding target records segment. The replacement must start at the index given in the COIX subfield. The number of coordinates to be replaced is given in the NCOR subfield.

Note that the index and number as given in the COIX and NCOR subfields refer to coordinate tuples not to single coordinates.

All coordinates in an update record must be stored in the same type of Coordinate field that is used in the target record and for 3D-coordinates the must refer to the same Vertical Datum as the coordinates in the target record.

### 10a-5.7.2 Curve record structure

Curve record

```

|
|--CRID (4): Curve Record Identifier field
|
|  -<0..*>-INAS (5\\*5): Information Association field
|
|  -<0..1>-PTAS (*3): Point Association field
|
|  -<0..1>-SECC (3): Segment Control field
|
|  -<0..*>-SEGH (1): Segment Header field
|
|    -<0..1>-COCC (3): Coordinate Control Field
|    alternate coordinate representations
|
|    *-<0..*>-C2IL (*2): 2-D Integer Coordinate List field
|
|    *-<0..*>-C3IL (1\\*3): 3-D Integer Coordinate List field
|
|    *-<0..*>-C2FL (*2): 2-D Floating Point Coordinate List field
|
|    *-<0..*>-C3FL (1\\*3): 3-D Floating Point Coordinate List
|
|    alternate parameter for circle and arc segments
|
|    *-<0..1>-CIPM (6): Circle Parameter field
|
|    *-<0..1>-ARPM (6): Arc Parameter field

```

**10a-5.7.2.1 Curve Record Identifier field structure**

Field Tag: <b>CRID</b>	Field Name: Curve Record Identifier
------------------------	-------------------------------------

Subfield name	Label	Format	Subfield content and specification
Record name	RCNM	b11	{120} - Curve
Record identification number	RCID	b14	Range: 1 to 2 <sup>32</sup> -2
Record version	RVER	b12	RVER contains the serial number of the record edition
Record update instruction	RUIN	b11	{1} - Insert {2} - Delete {3} - Modify

**Data Descriptive Field**

1100; &[ ] [ ] Curve [ ] Record [ ] Identifier ▲ RCNM! RCID! RVER! RUIN ▲ (b11, b14, b12, b11) ▼

**10a-5.7.2.2 Point Association field structure**

Field Tag: <b>PTAS</b>	Field Name: Point Association
------------------------	-------------------------------

Subfield name	Label	Format	Subfield content and specification
Referenced Record name	*RRNM	b11	Record name of the referenced record
Referenced Record identifier	RRID	b14	Record identifier of the referenced record
Topology indicator	TOPI	b11	{1} - Beginning point {2} - End point {3} - Beginning & End point

**Data Descriptive Field**

2100; &[ ] [ ] Point [ ] Association ▲ \*RRNM! RRID! TOPI ▲ (b11, b14, b11) ▼

**10a-5.7.2.3 Segment Control field structure**

Field Tag: <b>SECC</b>	[Upd]	Field Name: Segment Control
------------------------	-------	-----------------------------

Subfield name	Label	Format	Subfield content and specification
Segment update instruction	SEUI	b11	{1} - Insert {2} - Delete {3} - Modify
Segment index	SEIX	b12	Index (position) of the addressed segment in the target record
Number of segments	NSEG	b12	Number of segments in the update record

**Data Descriptive Field**

1100; &[ ] [ ] Segment [ ] Control ▲ SEUI! SEIX! NSEG ▲ (b11, 2b12) ▼



**10a-5.7.2.4 Segment Header field structure**

Field Tag: <b>SEGH</b>	Field Name: Segment Header
------------------------	----------------------------

Subfield name	Label	Format	Subfield content and specification
Interpolation	INTP	b11	{1} - Linear {2} - Arc3Points {3} - Geodesic {4} - Loxodromic {5} - Elliptical {6} - Conic {7} - CircularArcCenterPointWithRadius

**Data Descriptive Field**

1100; &□□□Segment□Header▲INTP ▲(b11)▼
---------------------------------------

### 10a-5.7.3 Circle Parameter field structure

Field Tag: <b>CIPM</b>	Field Name: Circle Parameter
------------------------	------------------------------

Subfield name	Label	Format	Subfield content and specification
Radius	RADI	b48	Radius of the circle
Unit of Radius	RADU	b11	{1} Metres {2} Yards {3} Kilometres {4} Statute miles {5} Nautical miles

#### Data Descriptive Field

```
1100; &[[[CircleParameter▲RADI!RADU▲(b48,b11)▼
```

### 10a-5.7.4 Arc Parameter field structure

Field Tag: <b>ARPM</b>	Field Name: Arc Parameter
------------------------	---------------------------

Subfield name	Label	Format	Subfield content and specification
Radius	RADI	b48	Radius of the circle
Unit of Radius	RADU	b11	{1} Metres {2} Yards {3} Kilometres {4} Statute miles {5} Nautical miles
Start Bearing Angle	SBRG	b48	In decimal degrees, range [0.0, 360.0]
Angular distance	ANGL	b48	In decimal degrees [-360.0, 360.0]

#### Data Descriptive Field

```
1100; &[[[ArcParameter▲RADI!RADU!SBRG!ANGL▲(b48,b11,2b48)▼
```

## 10a-5.8 Composite Curve record

### 10a-5.8.1 Encoding rules

Composite Curves are one-dimensional spatial objects that are composed of other curves. A composite curve itself is a contiguous path, i.e. the end of one component must be coincident with the start of the next component. Components are curves, although the direction in which they are used may be opposite to the direction in which the curve is defined originally. Which direction is used will be encoded in the ORNT subfield of the Curve Component field (CUCO).

The topological boundaries are not encoded explicitly. The beginning node is taken from the first component and the end node is taken from the last component. Which boundary is taken depends on the ORNT subfield.

Attributes and associations to information types can be encoded as for all other spatial objects.

Composite curves can have other composite curves as components. In this case the record of the component must be stored prior to the record which references the component.

Since the order of components is essential for the definition of the composite curve it must be maintained during an update. Therefore a special control field is used to update the sequence of components. This field contains an update instruction subfield (CCUI) that can have three values:

- 1) Insert:  
The components of the update record must be inserted in the sequence of components defined in the target record. The CCIX will define the index (position) where the components are to be inserted. The first component has the index 1. The NCCO subfield gives the number of components in the update record. The new components must be added to the dataset before references to them can be inserted into the composite curve.
- 2) Delete:  
Components must be deleted from the target record. The CCIX subfield will specify the index (position) of the first components to be deleted, The NCCO subfield gives the number of components to be deleted. Note that the component is only deleted from the sequence of components of the composite curve not from the data set.
- 3) Modify:  
The components in the target record will be replaced by the components in the update record. The first component to be replaced is given by the subfield CCIX, the number of components to be replaced is specified by the subfield NCCO. New components must be added to the dataset before references to them can be applied to the composite curve.

If more than one instruction is necessary to update the sequence of components multiple update records have to be encoded. Note that indices always refer to the latest version of the record i.e. if the indices of components have changed by one update record these changes have to be taken into account in every subsequent update record.

### 10a-5.8.2 Composite Curve record structure

Composite Curve record

```

|
|--CCID (4): Composite Curve Record Identifier field
|
|  |--<0..*>-INAS (5\\*5): Information Association field
|  |
|  |--<0..1>-CCOC (3): Curve Component Control field
|  |
|  |--<0..*>-CUCO (*3): Curve Component field
|

```

#### 10a-5.8.2.1 Composite Curve Record Identifier field structure

Field Tag: <b>CCID</b>	Field Name: Composite Curve Record Identifier
------------------------	---

Subfield name	Label	Format	Subfield content and specification
Record name	RCNM	b11	{125} - Composite Curve
Record identification number	RCID	b14	Range: 1 to $2^{32}-2$
Record version	RVER	b12	RVER contains the serial number of the record edition
Record update instruction	RUIN	b11	{1} - Insert {2} - Delete {3} - Modify

#### Data Descriptive Field

```
1100; &□□□Composite□Curve□Record□Identifier▲RCNM!RCID!RVER!RUIN▲(b11,b14,b12,b11)▼
```

#### 10a-5.8.2.2 Curve Component Control field structure

Field Tag: <b>CCOC</b>	[Upd] Field Name: Curve Component Control
------------------------	---

Subfield name	Label	Format	Subfield content and specification
Curve Component update instruction	CCUI	b11	{1} - Insert {2} - Delete {3} - Modify
Curve Component index	CCIX	b12	Index (position) of the addressed Curve record pointer within the CUCO field(s) of the target record
Number of Curve Components	NCCO	b12	Number of Curve record pointer in the CUCO field(s) of the update record

### Data Descriptive Field

```
1100; &[] [] Curve [] Component [] Control ▲ CCUI ! CCIX ! NCCO ▲ (b11, 2b12) ▼
```

### 10a-5.8.2.3 Curve Component field structure

Field Tag: <b>CUCO</b>	Field Name: Curve Component
------------------------	-----------------------------

Subfield name	Label	Format	Subfield content and specification
Referenced Record name	*RRNM	b11	Record name of the referenced record
Referenced Record identifier	RRID	b14	Record identifier of the referenced record
Orientation	ORNT	b11	{1} - Forward {2} - Reverse

### Data Descriptive Field

```
2100; &[] [] Curve [] Component ▲ *RRNM ! RRID ! ORNT ▲ (b11, b14, b11) ▼
```

## 10a-5.9 Surface Record

### 10a-5.9.1 Encoding rules

A surface is a two-dimensional spatial object. It is defined by its boundaries. Each boundary is a closed curve. Closed means that the start and the end point of that curve are coincident. A surface has exactly one exterior boundary and can have zero or more interior boundaries (holes in the surface).

All interior boundaries must be completely inside the exterior boundary and no interior boundary must be inside another interior boundary. Boundaries must not intersect but a tangential touch is allowed. Those boundaries, also called rings, are encoded with the Ring Association field. Each ring will be encoded by a reference to a curve record (RRNM and RRID), the orientation (ORNT) in which the curve is used and the indication whether this ring is exterior or interior (USAG). In Addition each ring is encoded with an update instruction (RAUI). Since the order how the ring associations are encoded is arbitrary there is no special update field to add or remove rings from a surface definition. This will be made with the Ring Association field and the appropriate Ring Association Update Instruction (RAUI) subfield.

### 10a-5.9.2 Surface Record structure

Surface record

```
|
|--SRID (4): Surface Record Identifier field
|
|  -<0..*>-INAS (5\\*5): Information Association field
|
|  -<1..*>-RIAS (*5): Ring Association field
```

**10a-5.9.2.1 Surface Record Identifier field structure**

Field Tag: <b>SRID</b>		Field Name: Surface Record Identifier	
Subfield name	Label	Format	Subfield content and specification
Record name	RCN M	b11	{130} - Surface
Record identification number	RCID	b14	Range: 1 to 2 <sup>32</sup> -2
Record version	RVE R	b12	RVER contains the serial number of the record edition
Record update instruction	RUIN	b11	{1} - Insert {2} - Delete {3} - Modify

**Data Descriptive Field**

```
1100; &[ ] [ ] Surface [ ] Record [ ] Identifier ▲ RCNM!RCID!RVER!RUIN▲ (b11, b14, b12, b11) ▼
```

**10a-5.9.2.2 Ring Association field structure**

Field Tag: <b>RIAS</b>		Field Name: Ring Association	
Subfield name	Label	Format	Subfield content and specification
Referenced Record name	*RRNM	b11	Record name of the referenced record
Referenced Record identifier	RRID	b14	Record identifier of the referenced record
Orientation	ORNT	b11	{1} - Forward {2} - Reverse
Usage indicator	USAG	b11	{1} - Exterior {2} - Interior
Ring Association update instruction	RAUI	b11	{1} - Insert {2} - Delete

**Data Descriptive Field**

```
2100; &[ ] [ ] Ring [ ] Association ▲ RRNM!RRID!ORNT!USAG!RAUI▲ (b11, b14, 3b11) ▼
```

## 10a-5.10 Feature Type record

### 10a-5.10.1 Encoding rules

An instance of a feature type is implemented in the data structure as a feature record. Feature types are listed in the feature catalogue of the data product. For each feature type the feature catalogue defines permissible attributes and associations. The feature catalogue defines also the two roles for each feature to feature association.

An S-100 compliant feature catalogue identifies 5 categories of feature types:

- 1) Meta feature
- 2) Cartographic feature
- 3) Geographic feature
- 4) Aggregated feature
- 5) Theme feature

Each category is implemented in the structure as a feature record and encoded in the same manner.

In the FRID field the code of the feature type is encoded. It must be a valid type from the feature catalogue of the data product. Note that for products using this encoding the feature catalogue must provide a 16-bit integer code.

The FOID field encodes a unique identifier for the instance of a feature type. Instances that are split into separate parts can have the same Feature Object Identifier indicating that this is the same feature object. This is possible for parts in the same data set but also for feature objects in different data sets. The latter case allows to identify parts of the same feature object in adjacent data sets or to determine identical feature objects in different scale bands.

The Feature Object Identifier is only used for implicit relationships not for referencing records directly. That is always done by the combination of the Referenced Record Name (RRNM) and Referenced Record Identifier (RRID).

Feature types are characterised by attributes and can have additional information associated by means of information types. Attributes are encoded by the Attribute field (ATTR) whereas the Information Association field is used for encoding the associations to information types.

The location of a feature object is defined by spatial objects. The association to these spatial objects is encoded with the Spatial Association field. It consists of a reference to the spatial object, an orientation flag, and two values which specifies the scale range for depicting the feature with the referenced geometry. The orientation flag is only necessary if the direction (of a curve) is meaningful for the feature object (e.g. a one-way street).

Feature types can have associations to other feature types. These associations including their roles are defined in the feature catalogue and must be encoded in the Feature Association field. Each relationship to another feature object is defined by:

- 1) The reference to the other feature object
- 2) The association used for the relationship (Given by the code from the Feature catalogue)
- 3) The code of the role used within the association. Each association between the objects A and B has two roles, one for the relationship from A to B and one from the relationship from B to A.

E.g. the association 'Aggregation' has the roles: 'Consists of' and 'Is part of'.

Note that only one direction of the relationship has to be encoded explicitly, the other direction is always implicit. E.g. an aggregation object has encoded the relationships to its parts but

there is no explicit encoding for the relationships from the parts to the aggregation object. For each association a separate field has to be used. The association itself can have attributes. The attributes are encoded in the field by the same mechanism as described for the ATTR field. The same subfields are used at the end of the association field

Theme objects are a special kind of aggregation objects. They do not define an object itself, but group other objects together. The reasons for the grouping are mostly thematic; other reasons are possible. Each feature object may belong to more than one theme. Themes are therefore not mutually exclusive. Since the kind of association from a theme object to its members (and vice versa) is not variable, the encoding of this type of association is different from the other feature associations. A separate field, the Theme Association field is used. The association is always encoded from the feature object that belongs to the theme to the theme object itself.

If parts of the geometry are intended not to be used for the depiction of a feature object these spatial objects can be specified in the Masked field. Note that spatial objects may not to be used directly by the feature object. E.g. If a feature object is defined by a surface only, a curve that forms a part of the surface boundary can be masked.

The MASK field consists of a reference to a record and an update instruction.

Note: When updating associations to other records, the other records must already exist in the target (base data or added by the appropriate update record).

### 10a-5.11 Feature Type record structure

Feature Type record

```

|
|--FRID (5): Feature Type Record Identifier field
|
|  -<0..1>-FOID (3): Feature Object Identifier field
|
|  -<0..*>-ATTR (*5): Attribute field
|
|  -<0..*>-INAS (5\\*5): Information Association field
|
|  -<0..*>-SPAS (*6): Spatial Association field
|
|  -<0..*>-FASC (5\\*5): Feature Association field
|
|  -<0..*>-THAS (*3): Theme Association field
|
|  -<0..*>-MASK (*4): Masked Spatial Type field

```

#### 10a-5.11.1 Feature Type Record Identifier field structure

Field Tag: <b>FRID</b>	Field Name: Feature Type Record Identifier
------------------------	--

Subfield name	Label	Format	Subfield content and specification
Record name	RCNM	b11	{100} - Feature type
Record identification number	RCID	b14	Range: 1 to $2^{32}-2$
Numeric Feature Type Code	NFTC	b12	A valid feature type code as defined in the FTCS field of the Dataset General Information Record
Record version	RVER	b12	RVER contains the serial number of the record edition
Record update instruction	RUIN	b11	{1} - Insert {2} - Delete {3} - Modify

**Data Descriptive Field**

```
1100; &[ ]Feature[ ]Type[ ]Record[ ]Identifier▲RCNM!RCID!NFTC!RVER!RUIN▲(b11, b14, 2b12, b11)▼
```

**10a-5.11.2 Feature Object Identifier field structure**

Field Tag: <b>FOID</b>	Field Name: Feature Object Identifier
------------------------	---------------------------------------

Subfield name	Label	Format	Subfield content and specification
Producing agency	AGEN	b12	Agency code
Feature identification number	FIDN	b14	Range: 1 to 2 <sup>32</sup> -2
Feature identification subdivision	FIDS	b12	Range: 1 to 2 <sup>16</sup> -2

**Data Descriptive Field**

```
1100; &[ ]Feature[ ]Object[ ]Identifier▲AGEN!FIDN!FIDS▲(b12, b14, b12)▼
```

**10a-5.11.3 Spatial Association field structure**

Field Tag: <b>SPAS</b>	Field Name: Spatial Association
------------------------	---------------------------------

Subfield name	Label	Format	Subfield content and specification
Referenced Record name	*RRNM	b11	Record name of the referenced record
Referenced Record identifier	RRID	b14	Record identifier of the referenced record
Orientation	ORNT	b11	{1} Forward {2} Reverse {255} NULL (Not Applicable)
Scale Minimum	SMIN	b14	Denominator of the largest scale for which the feature type can be depicted by the referenced spatial object. If the value is 0 it does not apply.
Scale Maximum	SMAX	b14	Denominator of the smallest scale for which the feature type can be depicted by the referenced spatial object. If the value is 2 <sup>32</sup> -1 it does not apply.
Spatial Association Update Instruction	SAUI	b11	{1} - Insert {2} - Delete

**Data Descriptive Field**

```
2100; &[ ]Spatial[ ]Association▲*RRNM!RRID!ORNT!SMIN!SMAX!SAUI!▲(b11, b14, b11, 2b14, b11)▼
```

**10a-5.11.4 Feature Association field**

Field Tag: <b>FASC</b>	Field Name: Feature Association
------------------------	---------------------------------

Subfield name	Label	Format	Subfield content and specification
Referenced Record name	RRNM	b11	Record name of the referenced record
Referenced Record identifier	RRID	b14	Record identifier of the referenced record
Numeric Feature Association Code	NFAC	b12	A valid code for the feature association as defined in the FACS field of the Dataset General Information Record
Numeric AssociationRole Code	NARC	b12	A valid code for the role as defined in the ARCS field of the Dataset General Information Record



Feature Association Update Instruction	FAUI	b11	{1} - Insert {2} - Delete {3} - Modify
Numeric Attribute Code	*NATC	b12	A valid attribute code as defined in the ATCS field of the Dataset General Information Record
Attribute index	ATIX	b12	Index (position) of the attribute in the sequence of attributes with the same code and the same parent (starting with 1).
Parent index	PAIX	b12	Index (position) of the parent complex attribute within this FASC field (starting with 1). If the attribute has no parent (top level attribute) the value is 0.
Attribute Instruction	ATIN	b11	{1} - Insert {2} - Delete {3} - Modify
Attribute value	ATVL	A()	A string containing a valid value for the domain of the attribute specified by the subfields above.

**Data Descriptive Field**

3600; &%/GFeature□Association▲RRNM!RRID!NFAC!NARC!APUI\\\*NATC!ATIX!PAIX!ATIN!ATVL ▲(b11, b14, 2b12, b11, 3b12, b11, A) ▼

**10a-5.11.5 Theme Association field**

Field Tag: <b>THAS</b>	Field Name: Theme Association
------------------------	-------------------------------

Subfield name	Label	Format	Subfield content and specification
Referenced Record name	*RRNM	b11	Record name of the referenced record
Referenced Record identifier	RRID	b14	Record identifier of the referenced record
Theme Association Update Instruction	TAUI	b11	{1} - Insert {2} - Delete

**Data Descriptive Field**

2100; &□□□Theme□Association▲\*RRNM!RRID!TAUI▲(b11, b14, b11) ▼

**10a-5.11.6 Masked Spatial Type field structure**

Field Tag: <b>MASK</b>	Field Name: Masked Spatial Type
------------------------	---------------------------------

Subfield name	Label	Format	Subfield content and specification
Referenced Record name	*RRNM	b11	Record name of the referenced record
Referenced Record identifier	RRID	b14	Record identifier of the referenced record
Mask Indicator	MIND	b11	{1} - Truncated by the dataset limit {2} - Suppress portrayal
Mask Update Instruction	MUIN	b11	{1} - Insert {2} - Delete

**Data Descriptive Field**

2100; &□□□Masked□Spatial□Record▲\*RRNM!RRID!MIND!MUIN▲(b11, b14, 2b11) ▼

# **S-100 Part 10b**

## **GML Data Format**

## Contents

10b-1	Scope .....	1
10b-2	Conformance .....	1
10b-3	References .....	1
10b-4	Introduction.....	2
10b-5	General concepts .....	2
10b-6	Notation and diagram conventions.....	2
10b-7	Components and relationships to standards.....	2
10b-7.1	Use of profile .....	3
10b-7.2	Interpretations .....	3
10b-8	Profile for feature data.....	3
10b-8.1	Feature and information types.....	3
10b-8.2	Feature collections .....	4
10b-8.3	Associations .....	4
10b-8.3.1	Association classes .....	4
10b-8.4	Data types .....	5
10b-8.4.1	Primitive types .....	5
10b-8.4.2	Value types.....	5
10b-8.4.3	Other data types.....	5
10b-8.5	Spatial types.....	6
10b-8.5.1	Geometric primitives.....	6
10b-8.5.2	Curve Interpolation .....	6
10b-8.5.3	Geometric complex, geometric composites, and geometric aggregates.....	6
10b-8.5.4	Inline and by-reference encoding.....	7
10b-8.5.5	Envelope.....	7
10b-8.6	Unsupported GML functionality .....	7
10b-8.7	Compliance levels .....	7
10b-9	S-100 base schema for feature data.....	8
10b-9.1	Introduction.....	8
10b-9.2	Features .....	8
10b-9.3	Information types.....	9
10b-9.4	Spatial types.....	9
10b-9.4.1	Inline and referenced geometry .....	10
10b-9.4.2	Spatial types defined in base schema.....	10
10b-9.5	Associations .....	11
10b-9.6	Dataset general information .....	14
10b-9.6.1	Dataset identification .....	14
10b-9.6.2	Dataset structure information .....	15
10b-9.7	Feature object identifier.....	16
10b-9.8	Coordinate Reference System .....	17
10b-9.9	Dataset structure definition.....	17
10b-9.9.1	Dataset metadata .....	17
10b-10	Constraints and validation .....	17
10b-11	Dataset level metadata and integrity checks.....	18
10b-12	Schema locations and namespaces .....	18
10b-13	Divergences from common GML practices .....	18
Appendix 10b-A	Application Schema (Informative).....	19
Appendix 10b-B	Use of Profile in GML Application Dataset (Informative) .....	23

## 10b-1 Scope

This Part specifies a profile of GML meant to be used as a basis for the development of GML application schemas for S-100 data products. The GML application schema for each data product defines a file format for the machine-to-machine exchange of information structured in conformance with the application schema for the data product, as defined in the appropriate product specification.

The scope of this Part includes:

- 1) Feature and information type data conforming to the S-100 General Feature Model defined in Part 3, encoded using GML (ISO 19136), and structured as datasets (identifiable collections of data).
- 2) Guidance for use of the schemas in application schemas for data products.

The following are outside scope:

- 1) A format for updates to datasets.
- 2) Interchange by means other than datasets encapsulated as files, such as Web Feature Service (WFS), other Web services, email, etc.
- 3) Information not encapsulated using GML, such as feature catalogues, exchange set metadata, portrayal catalogues, and support files in other XML formats.
- 4) Tools for developing GML application schemas for data products.
- 5) Design and programming of software for processing GML data.
- 6) Gridded and coverage data

## 10b-2 Conformance

The profile described in this Part conforms to the requirements for GML profiles described in ISO 19136.

## 10b-3 References

ISO 19106:2003 Geographic information - Geographic Information - Profiles  
 ISO 19107:2003 Geographic information - Spatial schema  
 ISO 19111:2007: Spatial referencing by coordinates (coordinate reference systems)  
 ISO 19118:2005, Geographic information — Encoding  
 ISO 19123:2005 Schema for coverage geometry and functions  
 ISO 19136:2007 Geographic information - Geography Markup Language  
 ISO/TS 19139: Geographic information — Metadata — XML schema implementation  
 ISO/IEC 19757-3: Information technology — Document Schema Definition Languages (DSDL) — Part 3: Rule-based validation — Schematron  
 IETF RFC 2396: Uniform Resource Identifiers (URI): Generic Syntax  
 IETF RFC 3986: Uniform Resource Identifiers (URI): Generic Syntax  
 W3C XLink: XML Linking Language (XLink) Version 1.0, W3C Recommendation  
 W3C XML Namespaces, Namespaces in XML, W3C Recommendation  
 W3C XML: Extensible Markup Language (XML) 1.0, W3C Recommendation  
 W3C XML Schema Part 1: XML Schema Part 1: Structures, W3C Recommendation  
 W3C XML Schema Part 2: XML Schema Part 2: Datatypes, W3C Recommendation  
 LEIRI: Legacy Extended IRIs for XML Resource Identification. W3C Working Group Note 3.  
 URL: <http://www.w3.org/TR/leiri>

## 10b-4 Introduction

The S-100 GML profile defines the core GML components that shall be used in GML encodings for S-100 data products. This profile defines a restricted subset of XML and GML types that excludes GML features not required by S-100 GML datasets. This profile of GML is contained in a single file and reduces the complexity of the full GML encoding to a more manageable level. A separate XML schema defines common elements and types needed for all S-100 datasets encoding feature-based information.

## 10b-5 General concepts

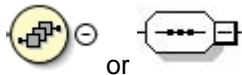
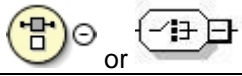
A GML application schema is an XML schema that conforms to the rules for application schemas given in the GML specification (ISO 19136).

A GML document is an XML document with a root element conforming to the rules for GML data specified in the GML specification (ISO 19136). Specifically, in the context of S-100 this means the root element must be a GML AbstractFeature or Dictionary element, or in a substitution group of any of these elements.

The terms “GML application schema” and “application schema” as used in this Part mean respectively an *XML schema* and a *conceptual schema*. The former may be an XSD file conforming to the XML schema rules, the latter a UML diagram.

These terms and definitions conform to ISO 19101 and ISO 19136. Complete definitions are given in ISO 19101 and ISO 19136, and are reproduced in Annex A.

## 10b-6 Notation and diagram conventions

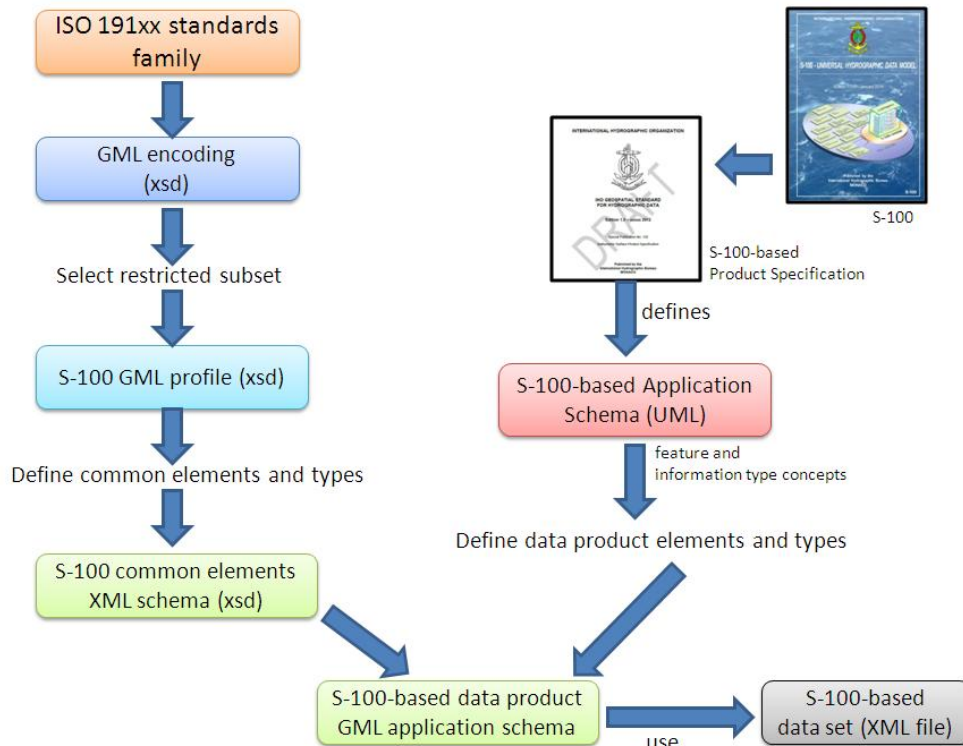
Diagram element	Meaning
	XML Schema <sequence>
	XML Schema <choice>
<u>0..∞</u>	XML schema multiplicity constraints (here, "0" and "unbounded")

## 10b-7 Components and relationships to standards

The GML data format for S-100 consists of the following components, realized as separate XML schemas:

- 1) An XML schema that defines a GML profile (“**Profile**”). This is a restricted subset of types and elements (“XML constructs”) defined in the GML 3.2.1 schemas. XML constructs not needed for S-100 data products are excluded.
- 2) An XML schema defining additional XML constructs (“**S100base**”). This schema uses the GML profile schema. The constructs defined in this schema are expected to be needed in order for a product specification conforming to the S-100 standard to define a format for datasets.

The figure below illustrates the dependency relationships. The GML encoding standard (ISO 19136:2007) provides an implementation schema (XML Schema) for the ISO 19100 conceptual schemas. The S-100 GML profile is a subset of the constructs defined by the GML implementation schema. S-100 common elements are defined in a common elements XML schema conforming to the profile. GML formats for specific data products use the constructs in the common elements schema in defining XML types and elements corresponding to feature and information types defined by the relevant Product Specification. A dataset is an XML file conforming to the GML data format (GML application schema).



**Figure 10b-1 – Derivation of profile and its use by a data product**

### 10b-7.1 Use of profile

The typical use of the profile is to define a format for GML files encapsulating datasets packaged as computer files.

Formats for modes of exchange other than datasets are not required to use these schemas.

The S-100 GML Profile has been defined to support validation and an application schema may import the GML 3.2.1 schemas or replace the <import> statement in the common elements with an <import> of the GML 3.2.1 schemas. To enable validation engines to understand that the S-100-based Application Schema adheres to a profile, the S-100 GML Profile must be declared within the schema. This allows the validation engine to select this schema instead of the GML 3.2.1 schema to validate the data against.

### 10b-7.2 Interpretations

The schema components of the GML profile which are part of the “gml” namespace are to be interpreted in conformance with GML as defined by ISO 19136, with the exceptions below.

- 1) “Linear” curve interpolation type in datasets using a geographic CRS shall be interpreted as loxodromic interpolation.

## 10b-8 Profile for feature data

### 10b-8.1 Feature and information types

The profile supports the ability to encode classes defined as identifiable objects as derived from either the abstract GML type or abstract feature type:

- AbstractGML (can be used to derive S-100 Information Classes)
- AbstractFeature (can be used to derive S-100 Feature Classes)

The S-100 GML Profile prohibits the use of the `gml:StandardObjectProperties` group.

### 10b-8.2 Feature collections

A feature collection is a collection of feature instances. Within GML 3.2.1, the generic `gml:FeatureCollection` element has been deprecated. A feature collection is any feature class with a property element in its content model (e.g. `member`) which is derived by extension from `gml:AbstractFeatureMemberType`.

In addition, the complex type describing the content model of the GML feature collection may also include a reference to the attribute group `gml:AggregationAttributeGroup` to provide additional information about the semantics of the object collection.

The S-100 GML Profile supports the GML 3.2.1 approach to model a Feature Collection class within an S-100 GML Application Schema.

### 10b-8.3 Associations

The profile allows associations to be encoded inline, by reference or either inline or by reference.

For bi-directional associations, the profile supports the encoding of the name of reverse property in the `applInfo` annotation element in the Application Schema XSD.

#### 10b-8.3.1 Association classes

The profile allows the GML 3.3 convention for encoding of association classes using the GML 3.3 association class conversion rule, which converts association classes to an equivalent intermediate class. The figures below illustrate the conversion rule.

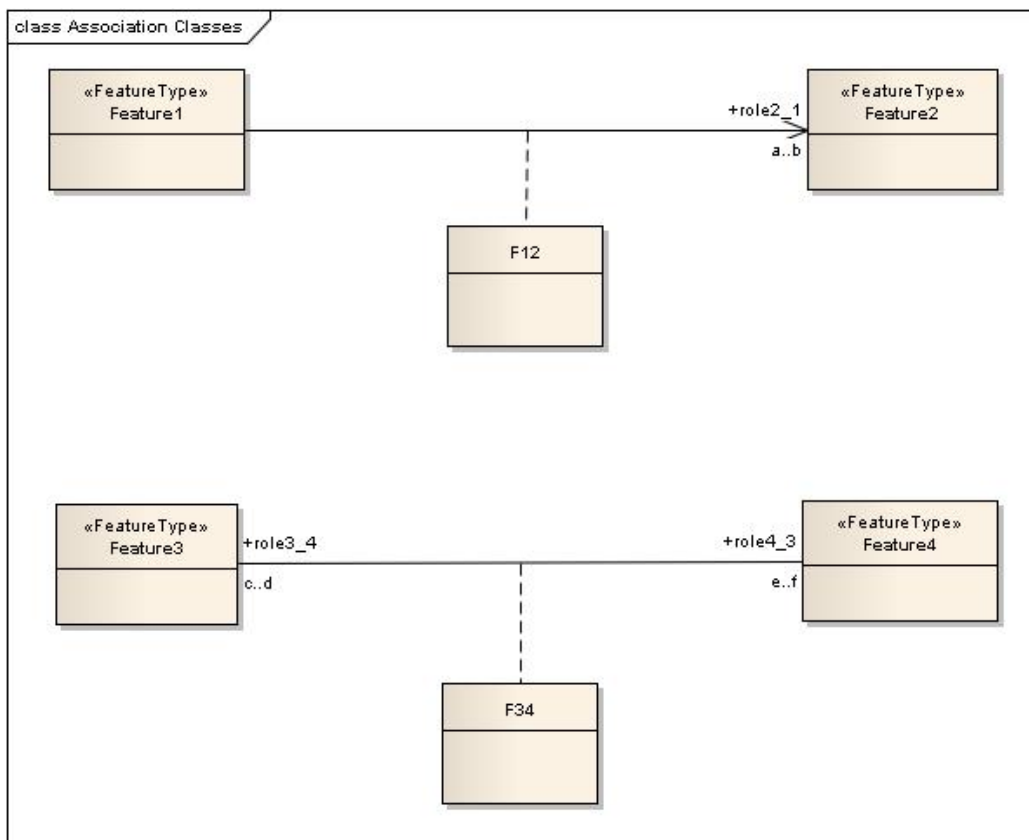
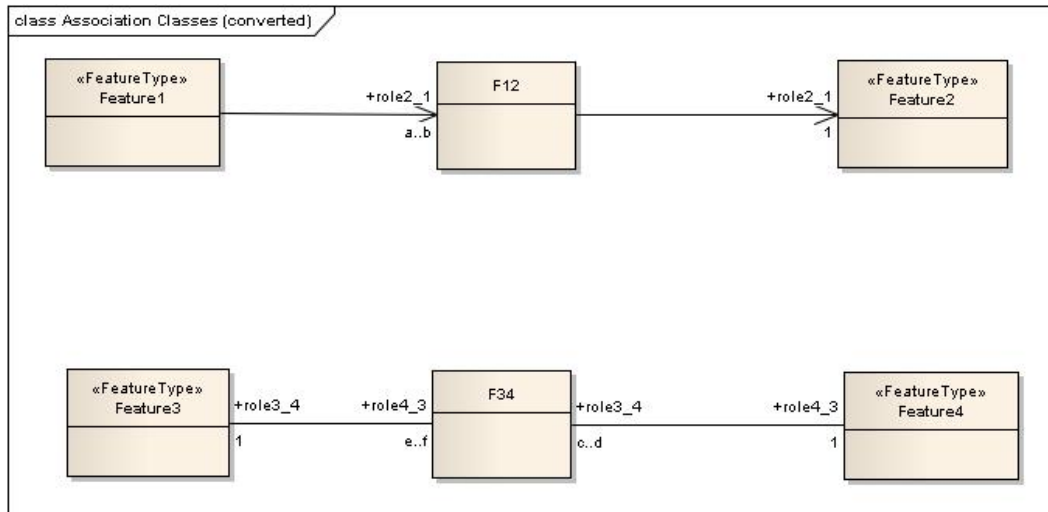


Figure 10b-2 – Model with association classes (from OGC 10-129r1 / ISO/DIS 19136-2)



**Figure 10b-3 – Model after conversion of association classes (from OGC 10-129r1 / ISO/DIS 19136-2)**

## 10b-8.4 Data types

### 10b-8.4.1 Primitive types

The S-100 GML Profile supports the primitive types defined in § 1-4.5.2:

- Boolean
- Integer
- Real
- CharacterString
- Date
- Time
- DateTime
- S100\_TruncatedDate
- URI, URN, URL

Types may be supported using XML Schema built-in data types.

### 10b-8.4.2 Value types

The S-100 GML Profile supports the value types defined in § 1-4.5.3.5:

- Measure
- Length
- Angle

NOTE: S100\_UnitsOfMeasure type shall be realised by the uom property, the value of which should reference to a value defined in a codelist register which provides the name, definition and symbol.

### 10b-8.4.3 Other data types

Application schemas describing data formats for data products may make use of built-in data types defined in “W3C XML Schema: Part 2” and additional data types to be defined within the GML Application Schema.

Example: The GML application schema encapsulating a data format may support the S-100 data type URI using the XML schema built-in type anyURI and S100\_TruncatedDate using one or more of the XML Schema built-in types gYear, gMonthDay, gDay, gYearMonth, gMonthDay, as governed by the product specification.



## 10b-8.5 Spatial types

### 10b-8.5.1 Geometric primitives

The S-100 GML Profile supports the GML 3.2.1 encodings of basic geometries (§ 7-5.1):

- Point
- AbstractCurve
- Curve
- OrientableCurve
- LineStringSegment
- Surface
- LineString
- Polygon
- S100\_ArcByCenterPoint
- S100\_CircleByCenterPoint

The S-100 GML Profile constrains the *GM\_CurveInterpolation* type values and constrains the curve encoding to a subset of GML curve geometries.

Note: *S100\_ArcByCenterPoint* and *S100\_CircleByCenterPoint* are not the same as the GML primitives *ArcByCenterPoint* and *CircleByCenterPoint*.

### 10b-8.5.2 Curve Interpolation

The list of allowable values is constrained to a subset of the values allowed by ISO 19136:

- 1) **Linear (linear) in a non-geographic CRS** – the interpolation is defined by a series of *DirectPositions* on a straight line between each consecutive pair of *controlPoints*.
- 2) **Linear interpolation (linear) in a geographic CRS (interpreted as Loxodromic)** – the interpolation method shall return *DirectPositions* on a loxodromic curve between each consecutive pair of *controlPoints*. A loxodrome is a line crossing all meridians at the same angle, i.e. a path of constant bearing.
- 3) **Geodesic (geodesic)** – the interpolation mechanism shall return *DirectPositions* on a geodesic curve between each consecutive pair of *controlPoints*. A geodesic curve is a curve of shortest length. The geodesic shall be determined in the coordinate reference system of the *GM\_Curve* in which the *GM\_CurveSegment* is used.
- 4) **Circular arc by 3 points (circularArc3Points)** – the interpolation is defined by a series of 3 *DirectPositions* on a circular arc passing from the start point through the middle point to the end point for each set of three consecutive *control points*. The middle point is located halfway between the start and end point.
- 5) **Elliptical arc (elliptical)** – for each set of four consecutive *controlPoints*, the interpolation mechanism shall return *DirectPositions* on an elliptical arc passing from the first *controlPoint* through the middle *controlPoints* in order to the fourth *controlPoint*. Note: if the four *controlPoints* are co-linear, the arc becomes a straight line. If the four *controlPoints* are on the same circle, the arc becomes a circular one.
- 6) **Conic arc (conic)** – the same as elliptical arc but using five consecutive points to determine a conic section.
- 7) **Circular arc with centre and radius (circularArcCenterPointWithRadius)** – the interpolation is defined by an arc of a circle of the specified radius centred at the position given by the single *control point*. The arc starts, at the start angle parameter and extends for the angle given by the angular distance parameter. This interpolation type shall be used only with *S100\_ArcByCenterPoint* and *S100\_CircleByCenterPoint* geometry. The precise semantics of the parameters are defined in clause 7-5.2.20 (*S100\_ArcByCenterPoint*).

### 10b-8.5.3 Geometric complex, geometric composites, and geometric aggregates

#### 10b-8.5.3.1 Geometric complex and geometric composites

The S-100 GML Profile supports the following composite geometries (§ 7-5.1):

- CompositeCurve

### 10b-8.5.3.2 Geometric aggregates

The S-100 GML Profile supports the aggregate geometry types (§ 7-5.1):

- MultiPoint

### 10b-8.5.4 Inline and by-reference encoding

The S-100 GML Profile supports the ability to encode a geometry either inline or by reference where two features share the same instance of a GM\_Object (see § 3-6.5.4.5).

### 10b-8.5.5 Envelope

The S-100 GML Profile supports the ability to encode an appropriate geometry via bounding box or envelope. The Profile does not constrain the use of the GML implementation of GM\_Envelope.

### 10b-8.6 Unsupported GML functionality

Support for GML 3.2.1 and GML 3.3 geometries not defined in ISO 19107 is not included. Specifically, this means CircleByCenterPoint and ArcByCenterPoint (as defined in GML 3.2.1) are not supported, nor are the compact geometry encodings defined in GML 3.3. S-100 Edition 2.0.0 provides different definitions for arc and circles by center point and radius.

The temporal model and temporal primitives defined in ISO 19108, including temporal positions, instants, time periods, are not supported. S-100 data should code dates and times as thematic attributes.

Dynamic features are not supported by the S-100 GML profile.

Topology is not supported by the S-100 GML profile.

Linear Referencing is not supported by the S-100 GML profile.

Coverages are not supported by the S-100 GML profile.

The ability to define coordinate reference systems is not supported. The products should be defined using a well-known, pre-defined coordinate reference system such as WGS84.

Observations are out of scope for the S-100 GML Profile. (The observations schema within GML has been superseded by the OGC (10-025r1) XML encoding for ISO 19156: Observations and Measurements.)

### 10b-8.7 Compliance levels

In order for a client to be able to properly interpret a schema, it needs a capability to identify the compliance level of the application schema. An XML Schema annotation shall be used for this purpose. The following schema fragment shows how this annotation shall be declared in an application schema<sup>1</sup>:

```
<annotation>
  <appinfo>
    <gmlProfileSchema xmlns="http://www.opengis.net/gml/3.2">
      http://www.ihp.int/S-100/profiles/s100\_GMLProfile.xsd
    </gmlProfileSchema>
    <s100:ComplianceLevel>1</s100:ComplianceLevel>
  </appinfo>
</annotation>
```

**Figure 10b-4 – Compliance declaration XML code**

<sup>1</sup> Line breaks and spaces have been added for clarity.

Compliance level	Description
1	S-100 feature types, information types, feature and information associations. Point, curve, and surface primitives.
2	All features of Level 1, plus circle and arc by center point geometry.

To manually add the compliance declaration to the schemas after they have been generated involves 3 steps:

1. Add the S-100 GML Profile XML Namespace declaration.

```
xmlns:s100_profile="http://www.iho.int/S-100/profile/s100_gmlProfile"
```

2. Add the S-100 GML Profile compliance declaration within the schema annotation. The compliance declaration is the XML code in Figure 10b-4 above.

3. Add an Import statement for the S-100 GML Profile Levels schema. Add the following import statement for the S-100 GML Profile Levels schema into the list of imported schemas to the list of imported schemas:

```
<import namespace="http://www.iho.int/S-100/profile/s100_gmlProfile"
  schemaLocation="../../../S100/profile/S100_gmlProfileLevels.xsd"/>
```

## 10b-9 S-100 base schema for feature data

### 10b-9.1 Introduction

A second XML schema is provided which defines a small set of derived types and elements in an “S100” namespace. The schema defining these common elements and types is technically a “GML application schema” in the sense defined by ISO 19136. It defines GML constructs which are expected to be used by different product specifications to define detailed GML application schemas encoding formats for GML datasets. This schema provides a common core structural paradigm for GML datasets across a variety of application domains. The intention is to reduce the complexity of application development, facilitate sharing of software modules, and information integration and mapping across different application domains, by minimising the proliferation of structural variations.

Elements and types are defined using the restricted subset of GML defined in the S-100 GML Profile.

### 10b-9.2 Features

An XML complex type `AbstractFeatureType` is defined as the base types for features. The `AbstractFeatureType` extends the `gml:AbstractFeatureType` as defined in the S-100 GML Profile by adding feature object identifier (§ 10b-9.7) and associations to feature and information objects (§ 10b-9.5). An inverse feature association is also included to allow reverse pointers for feature associations.

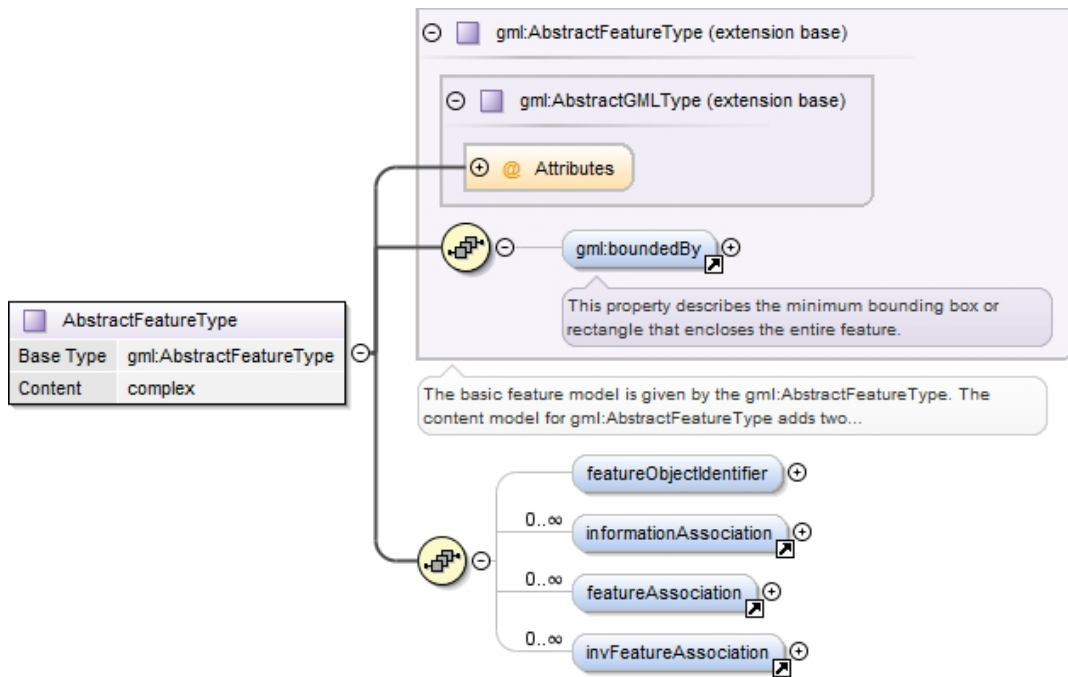


Figure 10b-5 – Base type definition for S-100 feature elements

### 10b-9.3 Information types

The common type definition for information types is similar to that for the common feature type, but omits the feature object identifier and feature associations.

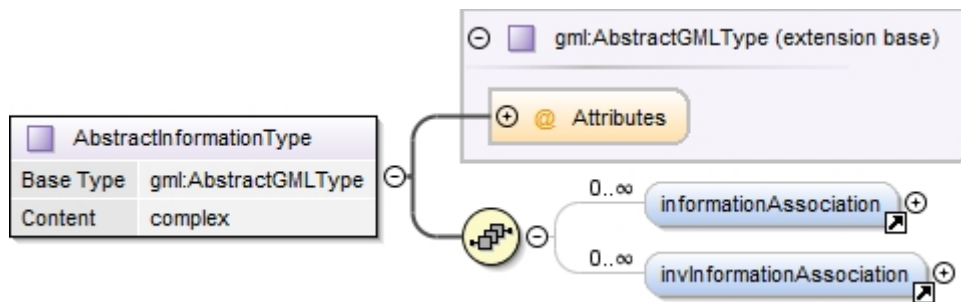


Figure 10b-6 – Base type definition for S-100 information type elements

### 10b-9.4 Spatial types

Spatial types are defined as extensions of the corresponding GML spatial types with an information association added, since in S-100 spatial objects can have information associations. The figure below shows the design of the Point type in the S-100 schema. It includes a single gml:Point type and 0 or more associations to S-100 information types.

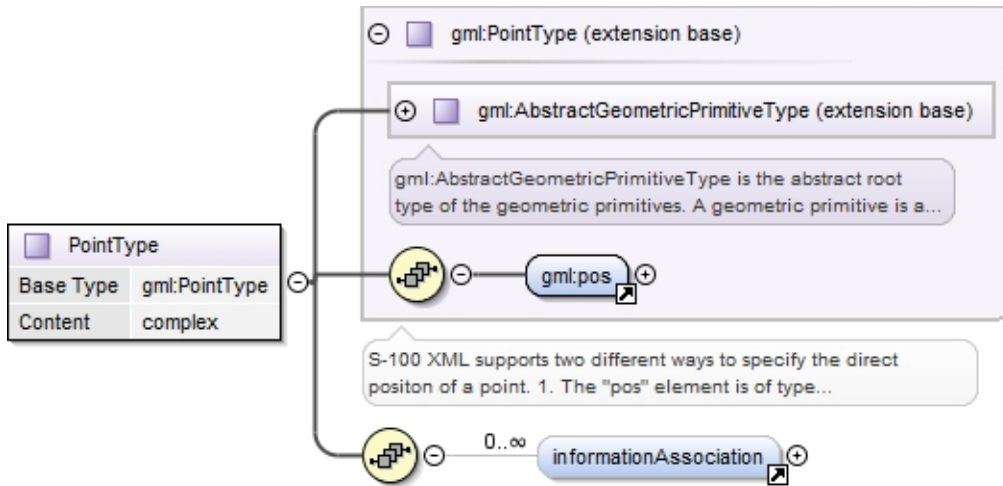


Figure 10b-7 – S-100 generic S-100 spatial type for point spatial object

The other spatial types have a similar structure.

10b-9.4.1 Inline and referenced geometry

The base schema also allows geometry to be defined either inline or by reference, conforming with the same ability in GML.

10b-9.4.2 Spatial types defined in base schema

The base schema defines the point, curve, and surface spatial objects, as well as multipoint and composite curve objects. Curves may be simple, composite, or orientable curves. This is the same set defined in the S-100 GML profile (§ 10b-8.5). It also supports *gml:Polygon* (ISO 19136) which is a special surface that is defined by a single surface patch.

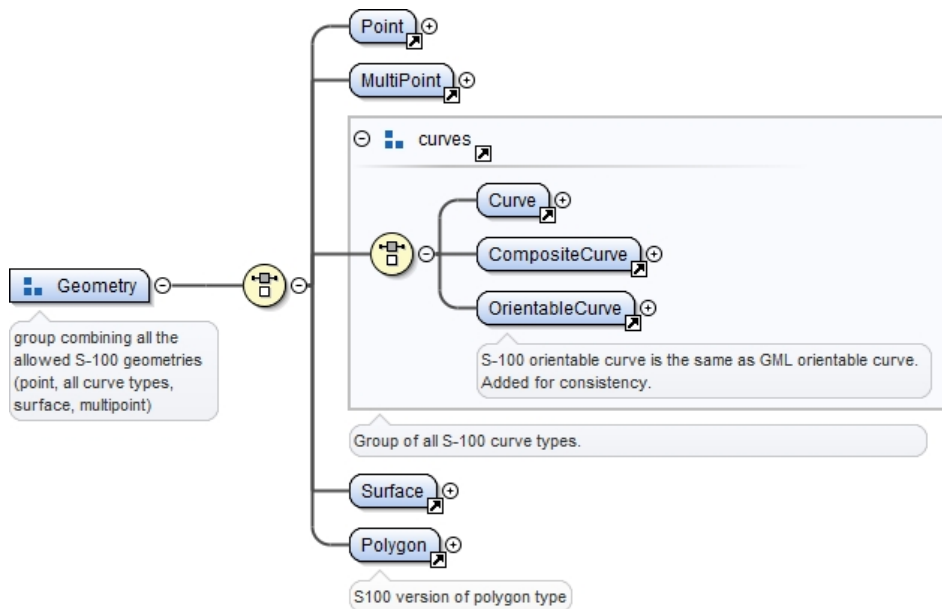


Figure 10b-8 – Geometry types defined in the base schema

### 10b-9.5 Associations

Feature and information association properties are defined as extensions of GML feature properties. The pointers to the object at the other end of the association are encoded in the Xlink attributes.

XLink components are the standard method to support hypertext referencing in XML. GML provides an XML Schema attribute group, *gml:AssociationAttributeGroup*, to support the use of Xlinks as the method for indicating the value of a property by reference in a uniform manner in GML. ISO 19136 specifies that the value of a GML property that carries an *xlink:href* attribute is the resource returned by traversing the link.

The data types of the attributes are listed in the table below.

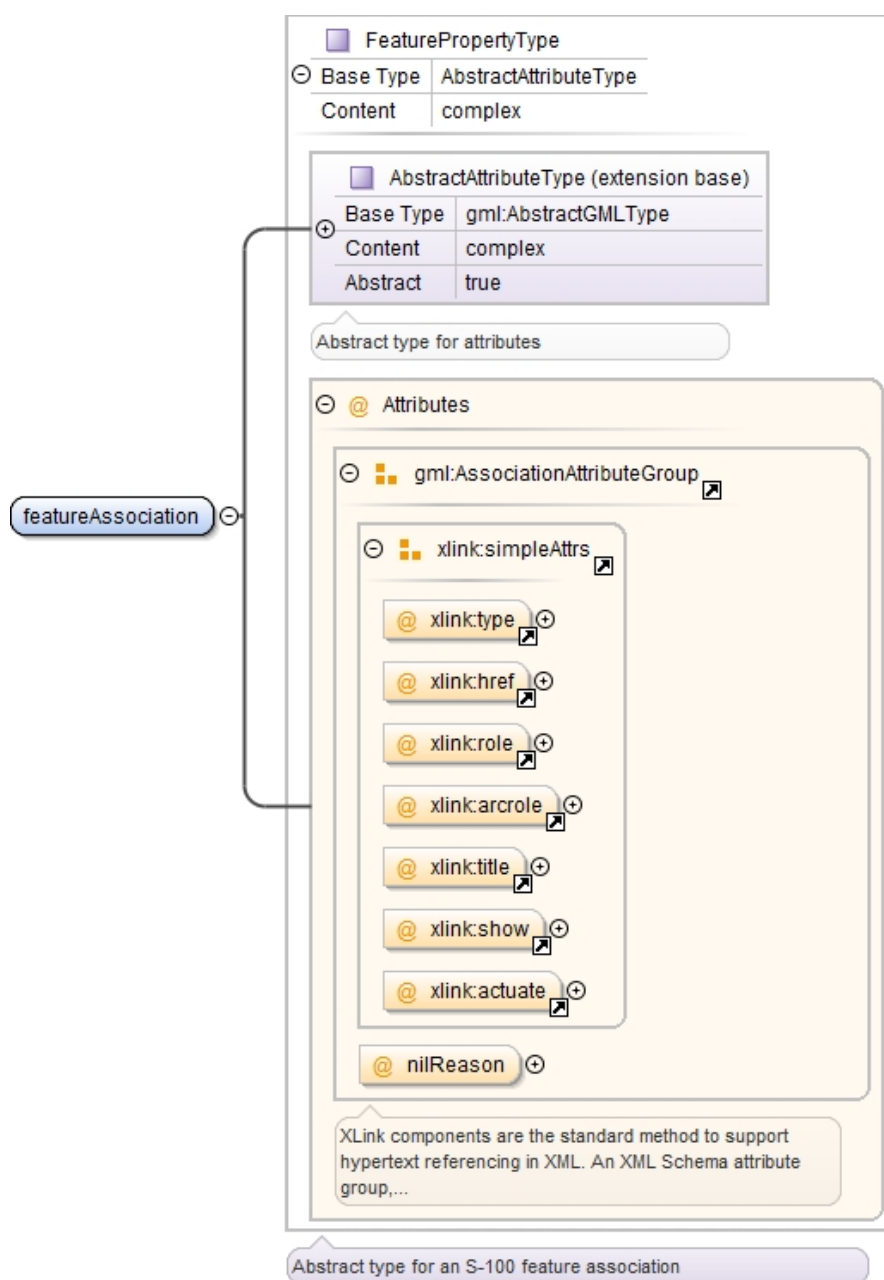
**Table 10b-1. Requirements for XLink attributes in associations**

Xlink attribute	Data type	Remarks
href	URI	Reference to the object at the other end of the association, e.g., the gml:id of an object in the current data set. May be a URI fragment as described in the XLink specification.
role	URI	Optional description of the nature of the target resource, given as a URI
arcrole	legacy extended IRI	Description of the role or purpose of the target resource in relation to the present resource, given as a URI (ISO 19136). May be constructed from the role name from the application schema. The XLink 1.1 specification requires: 1) The value must be a Legacy extended IRI. 2) The identifier must not be relative.
title	character string	Optional string describing the relationship. Product specifications may constrain its format and define its semantics.
show		not used
actuate		not used
type		not used

Product specifications may use one of the two methods described in the following sub-clauses to encode associations. Consistent use of a single method for each data product is strongly recommended.

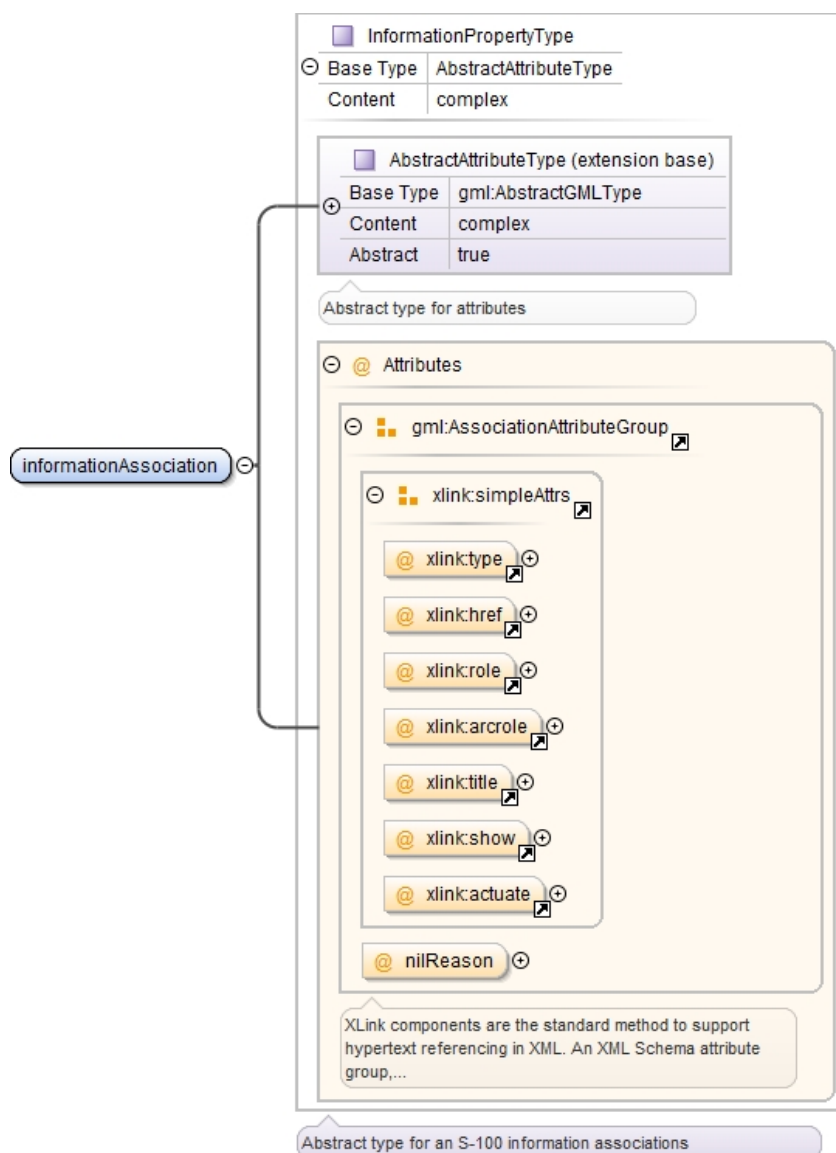
### 10b-9.5.1 Generic tags for associations

The profile defines two generic tags for feature and information associations, depicted in the figures below.



**Figure 10b-9 – S-100 type for feature association**

Information associations have a structure similar to feature associations except that they are information properties.



**Figure 10b-10 – S-100 type for information association**

Example (non-normative): Given the XML fragments below, the *MarineProtectedArea* feature has an information association to the *Regulations* information object.

```
<MarineProtectedArea gml:id="US123450"
  <informationAssociation xlink:href="#US50004"
    xlink:arcrole="http://www.iho.int/S-122/roles/theRegulations"/>
  ...
</MarineProtectedArea>
```

and elsewhere in the same file:

```
<Regulations gml:id="US50004">
  ...
</Regulations>
```

### 10b-9.5.2 Role name as property element

Alternatively, the roles defined in the application schema may be used as a property element of the feature or information type, with XLink attributes providing the reference to the instance. In this case the role at the far end of the association should be used for the XML tag defining



the property. The role name may be usable as-is for the property tag, or it may have to be mapped to a tag conforming to XML and GML conventions.

Example (non-normative): Given an application schema containing the relationship in the figure below, the *NavigationLine* feature can encode the association as a property element named *navTrack* as below. The format, construction rules, and semantics for the *arcrole* and *title* values would be defined in the product specification.

```
<NavigationLine gml:id="US123098">
  <navTrack xlink:href="#US890321"
            xlink:arcrole="urn:iho:s101:1.0:52.2" title="RangeSystem"/>
  ...
</NavigationLine>
```

and elsewhere in the same file:

```
<NavigationLine gml:id="US890321">
  <navLine xlink:href="#US123098"
            xlink:arcrole="urn:iho:s101:1.0:52.1" title="RangeSystem"/>
  ...
</NavigationLine>
```

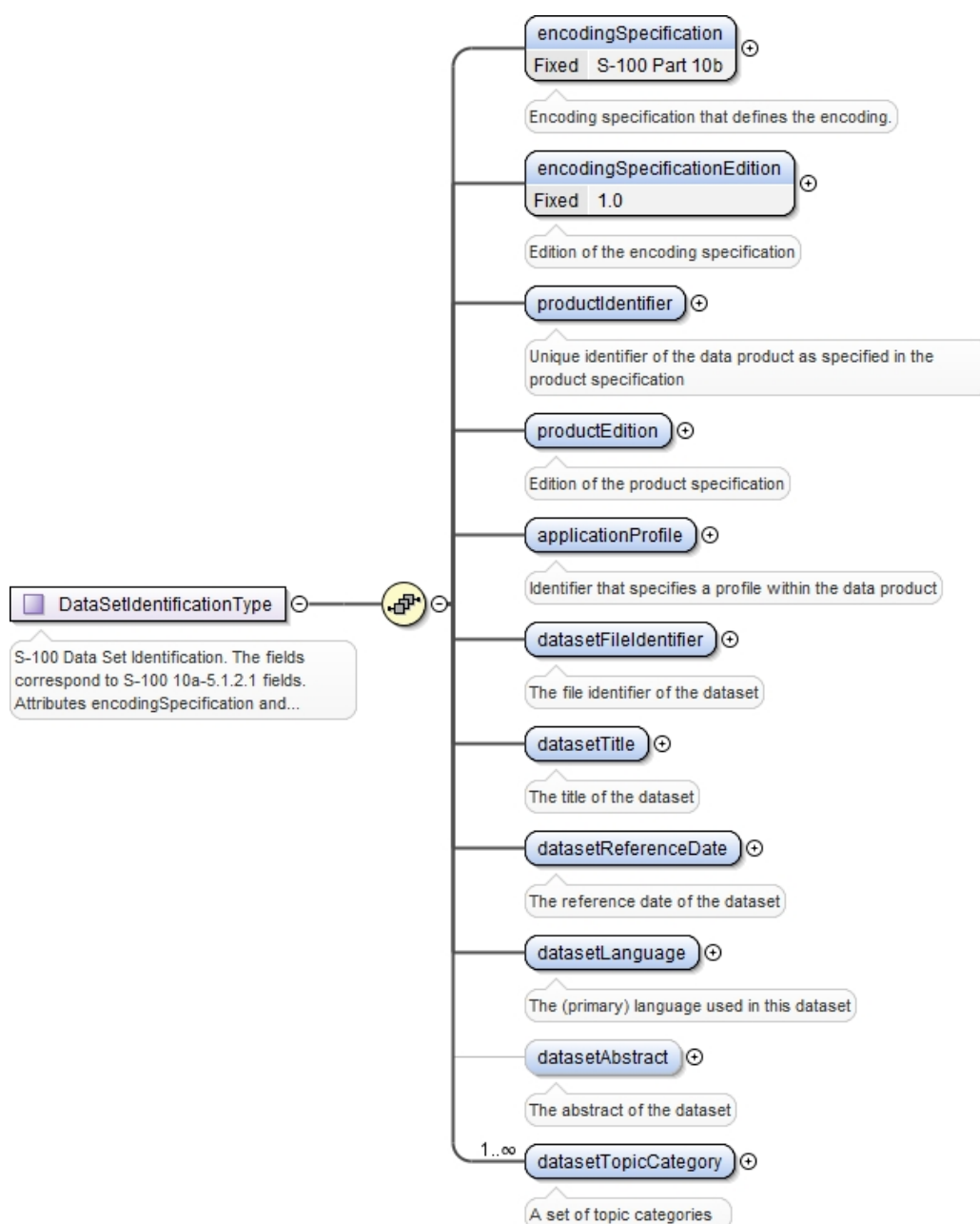


Figure 10b-11 – Association in application schema

## 10b-9.6 Dataset general information

### 10b-9.6.1 Dataset identification

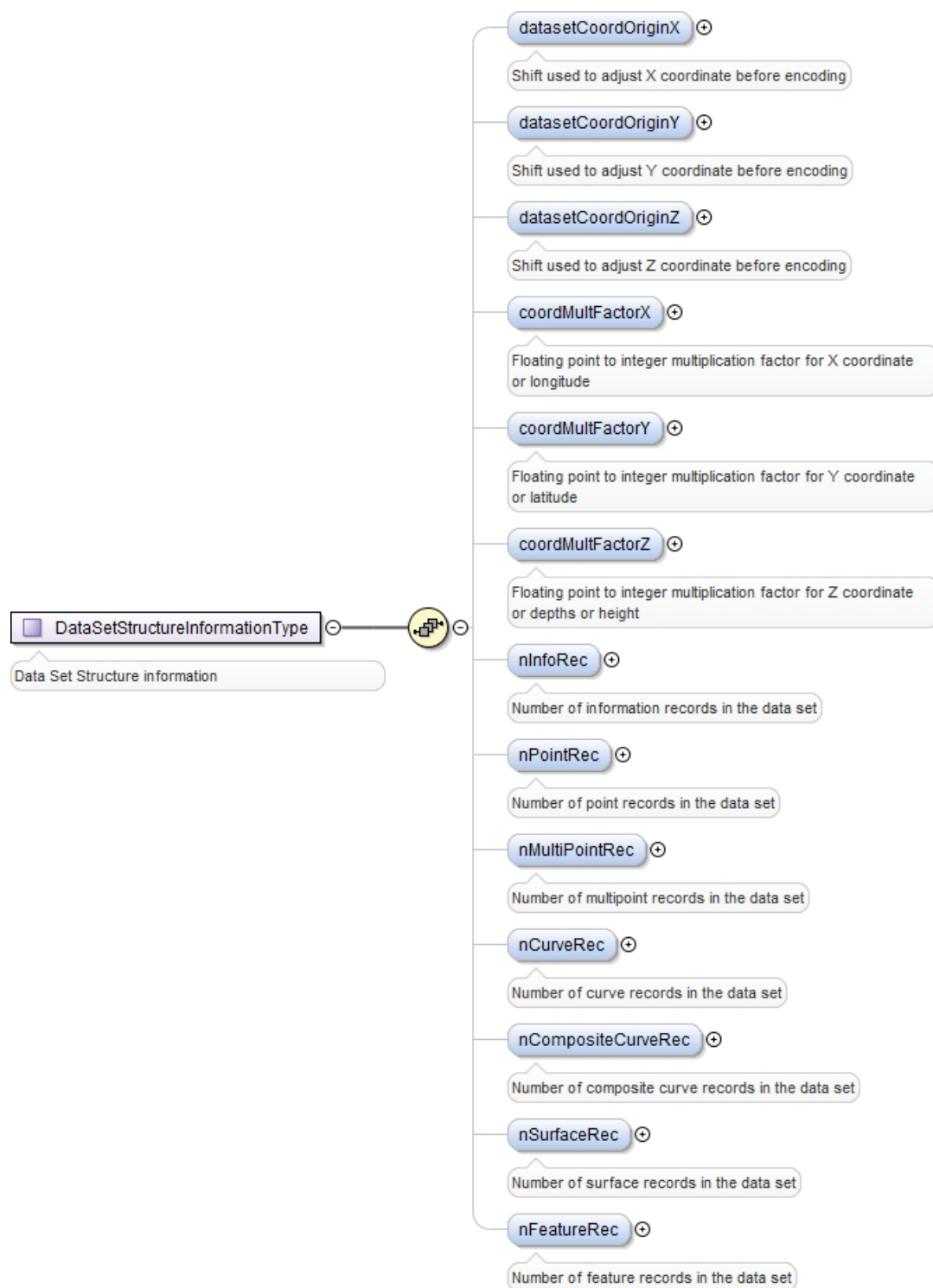
Dataset identification information is defined by the complex type *DatasetIdentificationType*. The fields are shown in the figure below.



**Figure 10b-12 – Dataset identification**

**10b-9.6.2 Dataset structure information**

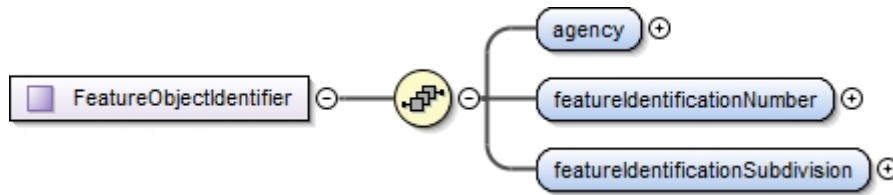
Dataset structure information is defined by the complex type *DatasetStructureInformationType*. The fields are shown in the figure below.



**Figure 10b-13 – Dataset structure information**

### 10b-9.7 Feature object identifier

The S-100 base schema provides a definition of feature object identifier structured similarly to the feature object identifier of S-57 Ed. 3.1.



**Figure 10b-14 – Structure of feature object identifier element**

### 10b-9.8 Coordinate Reference System

GML allows the coordinate reference system (“spatial reference system”) used for geometry to be determined in different ways – by explicit specification, or by “inheriting” the SRS of outer elements. For S-100 datasets, this means the SRS can be specified in one of two ways:

- Using the `srsName` attribute of the `gml:Envelope` element in a feature collection implies that the same SRS is used for all geometries contained in that collection.
- Using the `srsName` and `srsDimension` attributes for individual geometry elements.

Application data formats may use either method, but shall ensure that the SRS of every instance of geometry in a dataset can be determined by application software, using one method or another.

“Standard” geodetic coordinate reference systems shall be identified using the URI convention for SRS specified by OGC.

Example: <http://www.opengis.net/def/crs/EPSSG/0/4326>

### 10b-9.9 Dataset structure definition

Application schemas for data products shall define an XML type and element to serve as the root element of a GML dataset, consisting of a collection of XML elements for feature, information type, and spatial data objects defined elsewhere in the application schema.

#### 10b-9.9.1 Dataset metadata

The dataset class may contain one or metadata properties to encode dataset level metadata (e.g. ISO 19115/19139) either inline or by reference.

### 10b-10 Constraints and validation

Some validation of data can be done using validating XML processors if the data product’s GML application schema created well defined types wherever possible, e.g., enumerated types for the enumeration attributes, and maximum and minimum allowed values for real attributes. However, complete validation, especially of conditional attributes, is likely to require an additional means of data validation.

Constraints allow complex business rules to be defined that restrict the allowable values based on well-defined limits or relationships between properties (e.g. the end date must be equal to or greater than the start time).

Constraints can be defined in many different ways - human readable text only, object constraint language (OCL), Semantics of Business Vocabulary and Business Rules (SVBR) and these can be documented as part of the UML model or external to the model.

The S-100 GML Profile does not provide explicit support for expressing constraints or for rule-based validation. Current industry best practice, advocates the uses of Schematron to validate XML files based against business rules defined using OCL, SVBR or human readable text. Schematron (ISO/IEC 19757-3) is a rule-based validation language for making

assertions about the presence or absence of patterns in XML . Constraints encoded using Schematron may be directly encoded within the resulting Application Schema or may be defined in an associated Schematron document.

### 10b-11 Dataset level metadata and integrity checks

The S-100 GML Profile does not explicitly contain any elements relating to dataset level metadata or integrity checks. These should be defined within an S-100 Application Schema as properties of the Feature Collection class.

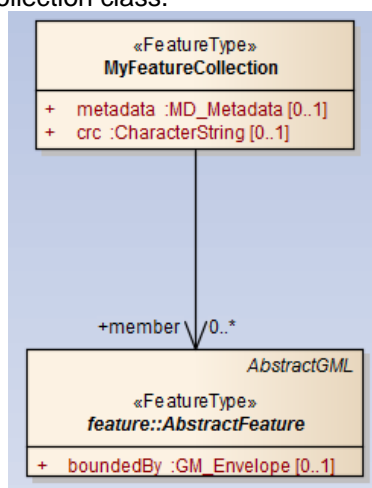


Figure 10b-15 – Encoding dataset metadata and integrity check properties

### 10b-12 Schema locations and namespaces

The GML profile and GML application schema for common elements are located at the IHO GI registry web site. Namespaces and versions are also defined on that site.

### 10b-13 Divergences from common GML practices

The GML profile (10b-8) and base schema (10b-9) diverge from common GML practice in the following items:

1. Interpretation of missing curve interpolation value (§§ 10b-7.2, 10b-8.5.2).
2. Allowing feature and information associations to use one of two standard properties <featureAssociation> and <informationAssociation> instead of the role name as the property name. The values XLink attributes in associations are specified as described in this Part which overrides the interpretations in the XLink specification.
3. Geometry properties are defined individually instead of using substitution groups. There is no single property which functions as a spatial attribute in all features.

## Appendix 10b-A Application Schema (Informative)

### 10b-A.1. Example of a GML application schema for an S-100-based data product

The example schema defines abstract base types for features and information types in the data product. Attributes common to all features/information types can be defined here. The abstract elements act as substitution group heads for feature and information type instances. This is convenient especially if the number of features or information type definitions is relatively high. GML also requires that features in GML application schemas be in the substitution group of *gml:AbstractFeature* and this can be achieved using the substitution groups.

```

<!-- base types for all features in this data product -->
<xs:complexType name="AbstractFeatureType">
  <xs:complexContent>
    <xs:extension base="s100:AbstractFeatureType">
      <xs:sequence>
        <xs:element name="scaleMinimum" type="xs:positiveInteger"/>
      </xs:sequence>
    </xs:extension>
  </xs:complexContent>
</xs:complexType>

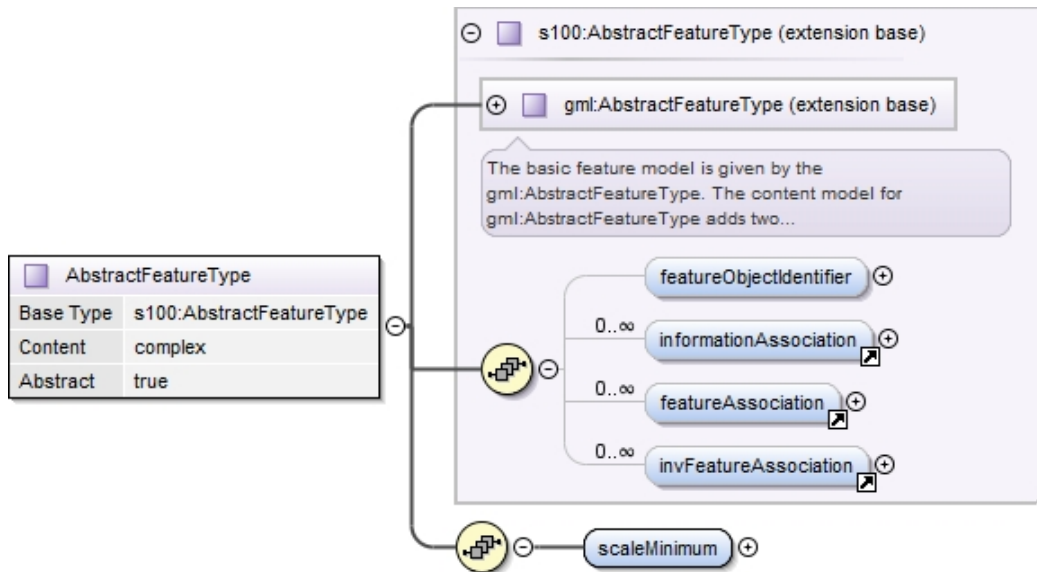
<xs:element name="AbstractFeature" type="AbstractFeatureType"
  abstract="true" substitutionGroup="gml:AbstractFeature">
  <xs:annotation>
    <xs:documentation>Substitution group head for features</xs:documentation>
  </xs:annotation>
</xs:element>

<!-- base types for all information types in this data product -->
<xs:complexType name="AbstractInformationTypeType">
  <xs:complexContent>
    <xs:extension base="s100:AbstractInformationType">
      <xs:sequence/>
    </xs:extension>
  </xs:complexContent>
</xs:complexType>
<xs:element name="AbstractInformationType" type="AbstractInformationTypeType"
  abstract="true" substitutionGroup="gml:AbstractGML">
  <xs:annotation>
    <xs:documentation>Substitution group head for information objects</xs:documentation>
  </xs:annotation>
</xs:element>

```

**Figure 10b-A-1 – Base abstract types and elements in GML application schema**

The figure below is a graphical representation of the model of *AbstractFeatureType*, defined above, showing the inherited feature identifier element, inherited association elements for feature and information associations, as well as the locally defined attribute *scaleMinimum*.



**Figure 10b-A-2 – Hierarchy of abstract types for features in GML application schema**

Information types are derived from the base type. The example has a single information type named `ChartNote`. Attributes specific to the information type are defined here.

```
<xs:complexType name="ChartNoteType">
  <xs:complexContent>
    <xs:extension base="AbstractInformationTypeType">
      <xs:sequence>
        <xs:element name="text" type="xs:string"/>
      </xs:sequence>
    </xs:extension>
  </xs:complexContent>
</xs:complexType>

<xs:element name="chartNote" type="ChartNoteType"
  substitutionGroup="AbstractInformationType">
  <xs:annotation>
    <xs:documentation>A chart note conveys information in plain text.</xs:documentation>
  </xs:annotation>
</xs:element>
```

**Figure 10b-A-3 – Information type definition**

The definition of feature classes is similar, except that they derive from `AbstractFeatureType` and include spatial attributes.

Since this data product requires alternative types of spatial properties for some feature classes (i.e., the `LandArea` feature can have either point or area geometry), geometry is defined as a *choice* element offering either point or surface property).

Note that the GML specification states that geometry properties shall have application-specific names which express the semantics:

*Application-specific names shall be chosen for geometry properties in GML application schemas. The names of the properties should be chosen to express the semantics of the value. Using application specific names is the preferred method for names of properties including geometry properties. There are no inherent restrictions in the type of geometry property a feature type may have as long as the property value is a geometry object substitutable for `gml:AbstractGeometry`.*

This profile therefore allows spatial attributes be implemented using geometry substitution groups or element names with application-specific semantics. The schema includes predefined property types which may be used as types of geometry property elements. However GML application schema developers should keep in mind the relevant requirements for stated in ISO 19136 e.g., in clause 10.1.3.1 about derivation from `gml:AbstractGeometryType` and substitution groups for geometry.

```
<!-- feature definitions -->
<xs:complexType name="DepthAreaType">
  <xs:complexContent>
    <xs:extension base="AbstractFeatureType">
      <xs:sequence>
        <xs:element name="depthValue1" type="xs:double"/>
        <xs:element name="depthValue2" type="xs:double"/>
        <xs:element ref="s100:surfaceProperty"/>
      </xs:sequence>
    </xs:extension>
  </xs:complexContent>
</xs:complexType>

<xs:element name="depthArea" type="DepthAreaType"
  substitutionGroup="AbstractFeature"/>

<xs:complexType name="LandAreaType">
  <xs:annotation>
    <xs:documentation>One of the features in this data product is
LandArea</xs:documentation>
  </xs:annotation>
  <xs:complexContent>
    <xs:extension base="AbstractFeatureType">
      <xs:sequence>
        <xs:element name="objectName" type="xs:string"/>
        <xs:choice>
          <xs:element ref="s100:pointProperty"/>
          <xs:element ref="s100:surfaceProperty"/>
        </xs:choice>
      </xs:sequence>
    </xs:extension>
  </xs:complexContent>
</xs:complexType>

<xs:element name="landArea" type="LandAreaType"
  substitutionGroup="AbstractFeature"/>
```

**Figure 10b-A-4 – Feature class definition**

The example also defines an XML type for datasets and convenience groups collecting features and information types for use in the dataset definition. Developers of GML application schemas should keep in mind the rules for GML application schemas in § 20 of ISO 19136.

The figure below shows a graphical representation of the *DepthArea* feature defined above, showing the components inherited from the abstract feature hierarchy and locally defined thematic attributes and allowed spatial attribute. The abstract type defined above is extended by adding the thematic attributes bound to the feature class and also the appropriate spatial attribute(s). A feature class may have different types of spatial objects associated with it, this can be represented using appropriate XML `<choice>` constructs.

Example: A feature may have either Point or Surface geometry but not curve geometry. This is represented by an XML `<choice>` particle containing point or surface property types but none of the curve types.



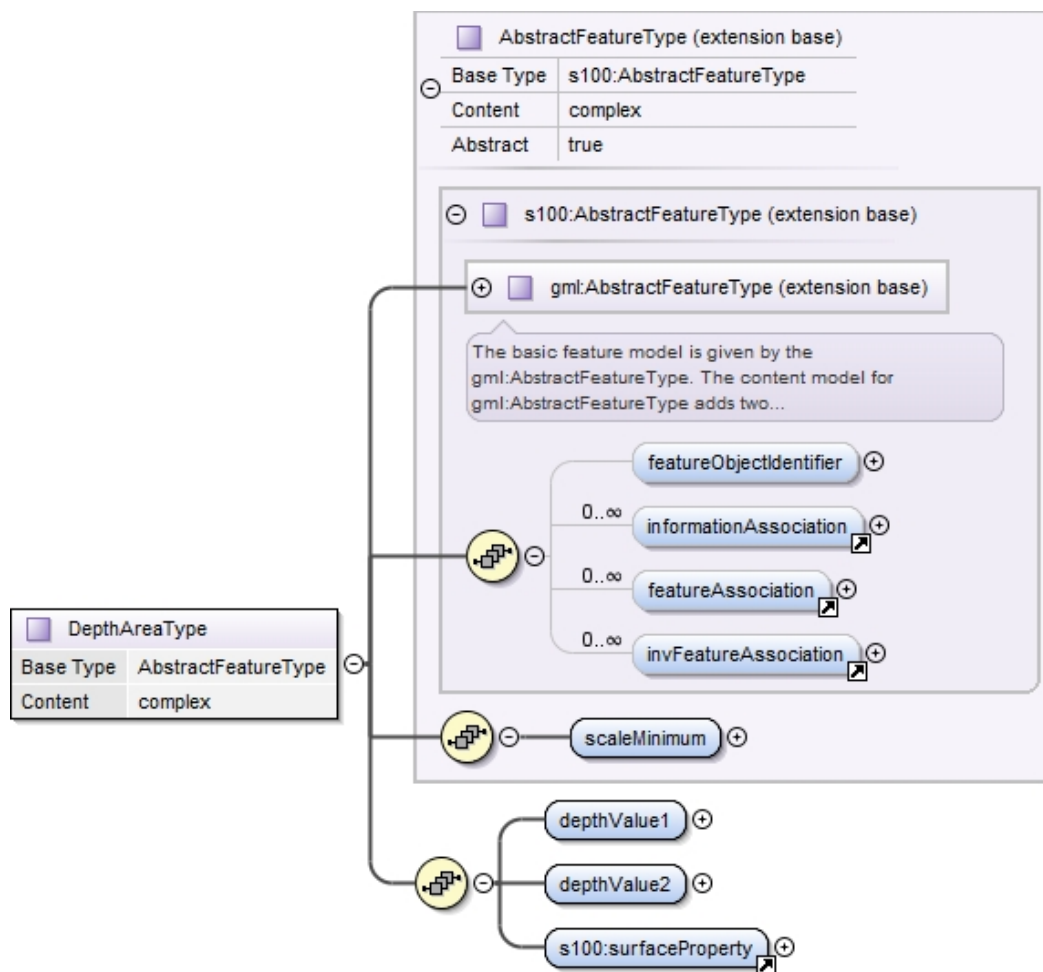


Figure 10b-A-5 – Type hierarchy of feature class in GML application schema

## Appendix 10b-B Use of Profile in GML Application Dataset (Informative)

### 10b-B.1. Introduction

This clause illustrates the use of the GML profile (10b-8) and base schema (10b-9) and a GML application schema (App. 10b-A) for an S-100-based data product and a GML dataset.

### 10b-B.2. Dataset structure in GML application schema

An example of the format of a GML dataset is shown in the figure below. This dataset defines data objects as information objects, spatial objects, or feature objects. It specifies the sequence of objects in the file as information objects first, followed by spatial objects, then features.

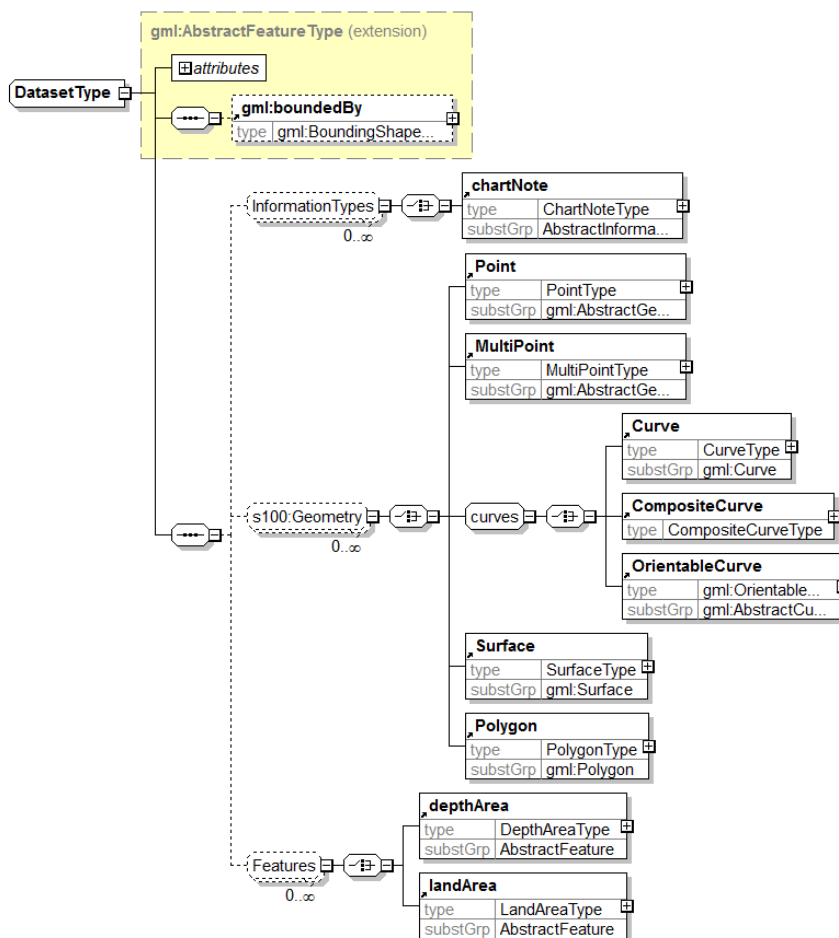


Figure 10b-B-1 – Example of dataset definition in GML application schema

### 10b-B.3. Dataset examples in XML/GML

The figure below shows a partial example dataset. Content in *italics* has been omitted for brevity.

```

<Dataset (... namespaces and schemaLocation ...) gml:id="ds">
  <gml:boundedBy>
    <gml:Envelope srsName="http://www.opengis.net/def/crs/EPSG/0/4326">
      <gml:lowerCorner>0.0 0.0</gml:lowerCorner>
      <gml:upperCorner>3.0 3.0</gml:upperCorner>
    </gml:Envelope>
  
```

```

</gml:boundedBy>

<!-- information objects -->
<chartNote gml:id="cn1">
  <text>The reporting area does not include the Areas to be Avoided within the
  Monument.</text>
</chartNote>

<chartNote gml:id="cn2">
  <text>Vessels shall notify the authority when leaving the reporting area to enter an
  Area to be Avoided.</text>
</chartNote>

<!-- spatial objects -->
<s100:Curve gml:id="curve1">... geometry of curve1 ...</s100:Curve>
<s100:Curve gml:id="curve2">... geometry of curve2 ...</s100:Curve>
<!-- curve3 references curve2 -->
<s100:OrientableCurve gml:id="curve3" orientation="-">
  <gml:baseCurve xlink:href="#curve2"/>
</s100:OrientableCurve>

<!-- this surface uses curve1 as boundary -->
<s100:Surface gml:id="sul">
  <gml:patches>
    <gml:PolygonPatch>
      <gml:exterior>
        <gml:Ring>
          <gml:curveMember xlink:href="#curve1"/>
        </gml:Ring>
      </gml:exterior>
    </gml:PolygonPatch>
  </gml:patches>
</s100:Surface>

<s100:Surface gml:id="su2">... geometry of surface su2 ...</s100:Surface>

<!-- features -->
<depthArea gml:id="da1">
  <s100:featureObjectIdentifier>
    <s100:agency>JS</s100:agency>
    <s100:featureIdentificationNumber>123</s100:featureIdentificationNumber>
    <s100:featureIdentificationSubdivision>345</s100:featureIdentificationSubdivision>
  </s100:featureObjectIdentifier>
  <scaleMinimum>10000</scaleMinimum>
  <depthValue1>1.0</depthValue1><!-- thematic attribute -->
  <depthValue2>6.0</depthValue2><!-- thematic attribute -->

  <!-- the geometry here is given by reference to surface sul above -->
  <s100:surfaceProperty xlink:href="#sul"/><!-- example of geometry reference -->
</depthArea>

<depthArea gml:id="da2">
  <s100:featureObjectIdentifier>
    <s100:agency>JS</s100:agency>
    <s100:featureIdentificationNumber>123</s100:featureIdentificationNumber>
    <s100:featureIdentificationSubdivision>345</s100:featureIdentificationSubdivision>
  </s100:featureObjectIdentifier>

  <!-- association to the first information object above, identified by its gml:id in
  the xlink:href attribute -->
  <s100:informationAssociation gml:id="ia2"
    xlink:href="#cn1"
    xlink:arcrole="http://example.iho.int/roles/hasNote"/>

  <!-- feature association to a depth area feature, identified by xlink:href -->
  <s100:featureAssociation gml:id="fa1"
    xlink:href="#da1"
    xlink:arcrole="http://example.iho.int/roles/rolea"/>

  <scaleMinimum>10000</scaleMinimum>
  <depthValue1>1.0</depthValue1>
  <depthValue2>6.0</depthValue2>

  <!-- geometry is given by reference -->
  <s100:surfaceProperty xlink:href="#su2"/>
</depthArea>

```

```
<landArea gml:id="la1">
  <scaleMinimum>10000</scaleMinimum>
  <objectName>Micklefirth City</objectName>
  <s100:pointProperty>
    <!-- inline geometry - directposition -->
    <s100:Point gml:id="pnt1">
      <gml:pos>1.5 1.5</gml:pos>
    </s100:Point>
  </s100:pointProperty>
</landArea>

</Dataset>
```

**Figure 10b-B-2 – Example GML dataset**

# **S-100 Part 10c**

## **HDF5 Data Model and File Format**

Copyright Notice and License Terms for  
HDF5 (Hierarchical Data Format 5) Software Library and Utilities  
-----

HDF5 (Hierarchical Data Format 5) Software Library and Utilities  
Copyright 2006-2015 by The HDF Group.

NCSA HDF5 (Hierarchical Data Format 5) Software Library and Utilities  
Copyright 1998-2006 by the Board of Trustees of the University of Illinois.

All rights reserved.

Redistribution and use in source and binary forms, with or without modification, are permitted for any purpose (including commercial purposes) provided that the following conditions are met:

1. Redistributions of source code must retain the above copyright notice, this list of conditions, and the following disclaimer.
2. Redistributions in binary form must reproduce the above copyright notice, this list of conditions, and the following disclaimer in the documentation and/or materials provided with the distribution.
3. In addition, redistributions of modified forms of the source or binary code must carry prominent notices stating that the original code was changed and the date of the change.
4. All publications or advertising materials mentioning features or use of this software are asked, but not required, to acknowledge that it was developed by The HDF Group and by the National Center for Supercomputing Applications at the University of Illinois at Urbana-Champaign and credit the contributors.
5. Neither the name of The HDF Group, the name of the University, nor the name of any Contributor may be used to endorse or promote products derived from this software without specific prior written permission from The HDF Group, the University, or the Contributor, respectively.

**DISCLAIMER:**

THIS SOFTWARE IS PROVIDED BY THE HDF GROUP AND THE CONTRIBUTORS "AS IS" WITH NO WARRANTY OF ANY KIND, EITHER EXPRESSED OR IMPLIED. In no event shall The HDF Group or the Contributors be liable for any damages suffered by the users arising out of the use of this software, even if advised of the possibility of such damage.

## Contents

<b>10c-1</b>	<b>Scope</b> .....	<b>1</b>
<b>10c-2</b>	<b>Conformance</b> .....	<b>1</b>
<b>10c-3</b>	<b>References</b> .....	<b>1</b>
<b>10c-4</b>	<b>Abbreviations</b> .....	<b>1</b>
<b>10c-5</b>	<b>HDF5 Specification</b> .....	<b>1</b>
<b>10c-5.1</b>	<b>Abstract Data Model</b> .....	<b>3</b>
<b>10c-5.1.1</b>	<b>File</b> .....	<b>3</b>
<b>10c-5.1.2</b>	<b>Group</b> .....	<b>3</b>
<b>10c-5.1.3</b>	<b>Dataset</b> .....	<b>4</b>
<b>10c-5.1.4</b>	<b>Dataspace</b> .....	<b>5</b>
<b>10c-5.1.5</b>	<b>DataType</b> .....	<b>5</b>
<b>10c-5.1.6</b>	<b>Attribute</b> .....	<b>6</b>
<b>10c-5.1.7</b>	<b>Property List</b> .....	<b>7</b>
<b>10c-5.2</b>	<b>HDF5 Library and Programming Model</b> .....	<b>8</b>

## 10c-1 Scope

The Hierarchical Data Format 5 (HDF5) HDF has been developed by the HDFgroup as a file format for the transfer of data that is used for imagery and gridded data. This Part specifies an interchange format to facilitate the moving of files containing data records between computer systems. It defines a specific structure which can be used to transmit files containing data type and data structures specific to S-100.

## 10c-2 Introduction

HDF5 uses an open source format. It allows users such as the IHO to collaborate with The HDF Group regarding functionality requirements and permits users' experience and knowledge to be incorporated into the HDF product when appropriate.

HDF5 is particularly good at dealing with data where complexity and scalability are important. Data of virtually any type or size can be stored in HDF5, including complex data structures and data types. HDF5 is portable, running on most operating systems and machines. HDF5 is scalable - it works well in high end computing environments, and can accommodate data objects of almost any size or multiplicity. It also can store large amounts of data efficiently - it has built-in compression. HDF5 is widely used in government, academia, and industry.

## 10c-3 Conformance

The S-100 HDF5 data format conforms to release 1.8.8 of HDF5.

## 10c-4 References

The HDF Group, November 2011, *HDF5 User's Guide Release 1.8.8*

The HDF Group, November 2011, *HDF5 Reference Manual 1.8.8*

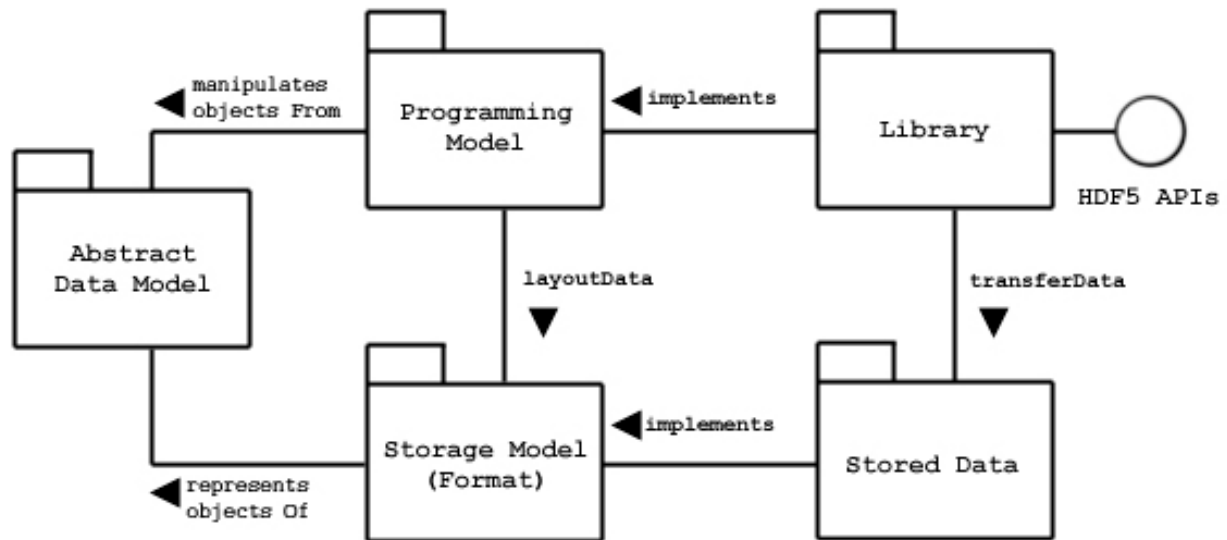
## 10c-5 Abbreviations

HDF Hierarchical Data Format  
API Application Program Interface

## 10c-6 HDF5 Specification

HDF5 implements a model for managing and storing data. The model includes an abstract data model and an abstract storage model (the data format), and libraries to implement the abstract model and to map the storage model to different storage mechanisms. The HDF5 library provides a programming interface to a concrete implementation of the abstract models. The library also implements a model of data transfer, i.e., efficient movement of data from one stored representation to another stored representation. The figure below illustrates the relationships between the models and implementations.





**Figure 1 - Abstract Data Model**

The *Abstract Data Model* is a conceptual model of data, data types, and data organization. The abstract data model is independent of storage medium or programming environment. The *Storage Model* is a standard representation for the objects of the abstract data model. The *HDF5 File Format Specification* defines the storage model.

The *Programming Model* is a model of the computing environment and includes platforms from small single systems to large multiprocessors and clusters. The programming model manipulates (instantiates, populates, and retrieves) objects from the abstract data model.

The *Library* is the concrete implementation of the programming model. The Library exports the HDF5 APIs as its interface. In addition to implementing the objects of the abstract data model, the Library manages data transfers from one stored form to another. Data transfer examples include reading from disk to memory and writing from memory to disk.

*Stored Data* is the concrete implementation of the storage model. The storage model is mapped to several storage mechanisms including single disk files, multiple files (family of files), and memory representations.

The HDF5 Library is a C module that implements the programming model and abstract data model. The HDF5 Library calls the operating system or other storage management software (e.g., the MPI/IO Library) to store and retrieve persistent data. The HDF5 Library may also link to other software such as filters for compression. The HDF5 Library is linked to an application program which may be written in C, C++, Fortran, or Java. The application program implements problem specific algorithms and data structures and calls the HDF5 Library to store and retrieve data.

The HDF5 Library implements the objects of the HDF5 abstract data model. Some of these objects include groups, datasets, and attributes. A S-100 product specification maps the S-100 data structures to a hierarchy of HDF5 objects. Each S-100m product specification will create a mapping best suited to its purposes.

The objects of the HDF5 abstract data model are mapped to the objects of the HDF5 storage model, and stored in a storage medium. The stored objects include header blocks, free lists, data blocks, B-trees, and other objects. Each group or dataset is stored as one or more header and data blocks.

## 10c-6.1 Abstract Data Model

The abstract data model (ADM) defines concepts for defining and describing complex data stored in files. The ADM is a very general model which is designed to conceptually cover many specific models. Many different kinds of data can be mapped to objects of the ADM, and therefore stored and retrieved using HDF5. The ADM is not, however, a model of any particular problem or application domain. Users need to map their data to the concepts of the ADM.

The key concepts include:

- *File* - a contiguous string of bytes in a computer store (memory, disk, etc.), and the bytes represent zero or more objects of the model
- *Group* - a collection of objects (including groups)
- *Dataset* - a multidimensional array of data elements with attributes and other metadata
- *Dataspace* - a description of the dimensions of a multidimensional array
- *Datatype* - a description of a specific class of data element including its storage layout as a pattern of bits
- *Attribute* - a named data value associated with a group, dataset, or named datatype
- *Property List* - a collection of parameters (some permanent and some transient) controlling options in the library
- *Link* - the way objects are connected

These key concepts are described in more detail below.

### 10c-6.1.1 File

Abstractly, an HDF5 file is a container for an organized collection of objects. The objects are groups, datasets, and other objects as defined below. The objects are organized as a rooted, directed graph. Every HDF5 file has at least one object, the root group. See the figure below. All objects are members of the root group or descendants of the root group.

HDF5 objects have a unique identity *within a single HDF5 file* and can be accessed only by its names within the hierarchy of the file. HDF5 objects in different files do not necessarily have unique identities, and it is not possible to access a permanent HDF5 object except through a file.

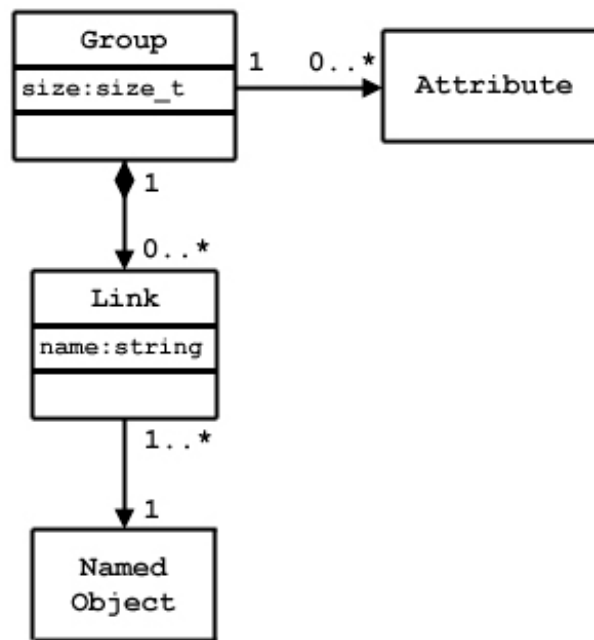
When the file is created, the *file creation properties* specify settings for the file. The file creation properties include version information and parameters of global data structures. When the file is opened, the *file access properties* specify settings for the current access to the file. File access properties include parameters for storage drivers and parameters for caching and garbage collection. The file creation properties are set permanently for the life of the file, and the file access properties can be changed by closing and reopening the file.

An HDF5 file can be “mounted” as part of another HDF5 file. This is analogous to Unix file system mounts. The root of the mounted file is attached to a group in the mounting file, and all the contents can be accessed as if the mounted file were part of the mounting file.

### 10c-6.1.2 Group

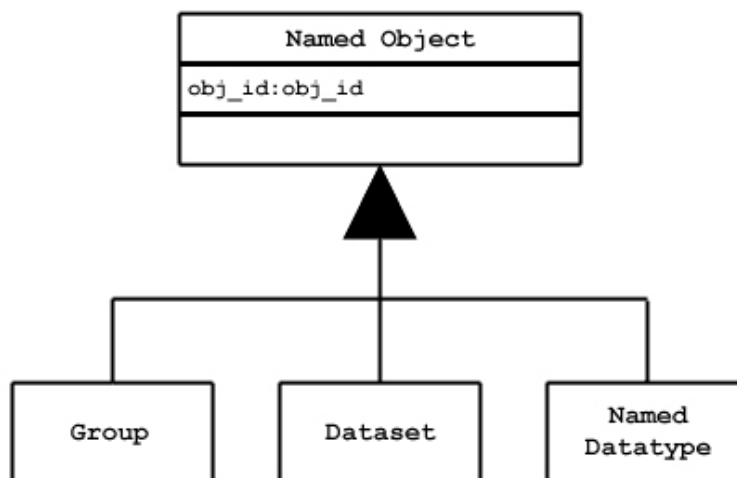
An HDF5 group is analogous to a file system directory. Abstractly, a group contains zero or more objects, and every object must be a member of at least one group. The root group is a special case; it may not be a member of any group.

Group membership is actually implemented via link objects. See the figure below. A link object is owned by a group and points to a named object. Each link has a name, and each link points to exactly one object. Each named object has at least one and possibly many links to it.



**Figure 2 - Group membership via link objects**

There are three classes of named objects: group, dataset, and named datatype. See the figure below. Each of these objects is the member of at least one group, and this means there is at least one link to it.



**Figure 3 - Classes of named objects**

### 10c-6.1.3 Dataset

An HDF5 dataset is a multidimensional array of data elements. See the figure below. The shape of the array (number of dimensions, size of each dimension) is described by the dataspace object.

A data element is a single unit of data which may be a number, a character, an array of numbers or characters, or a record of heterogeneous data elements. A data element is a set of bits. The layout of the bits is described by the datatype.

The dataspace and datatype are set when the dataset is created, and they cannot be changed for the life of the dataset. The dataset creation properties are set when the dataset is created. The dataset creation properties include the fill value and storage properties such as chunking and compression. These properties cannot be changed after the dataset is created.

The dataset object manages the storage and access to the data. While the data is conceptually a contiguous rectangular array, it is physically stored and transferred in different ways depending on the storage properties and the storage mechanism used. The actual storage may be a set of compressed chunks, and the access may be through different storage mechanisms and caches. The dataset maps between the conceptual array of elements and the actual stored data.

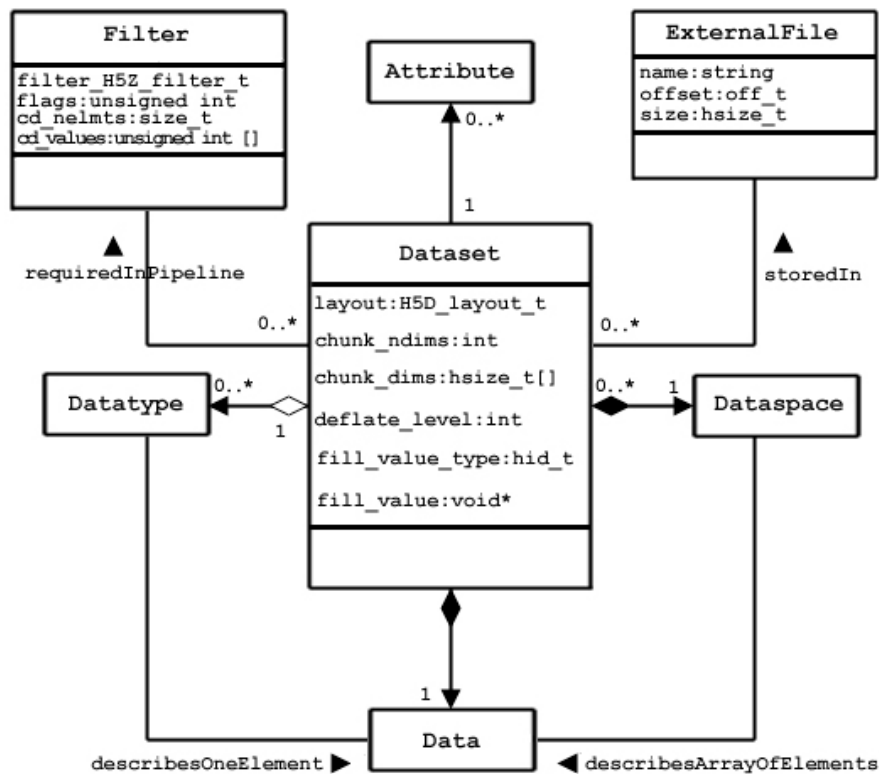


Figure 4 - The dataset

#### 10c-6.1.4 Dataspace

The HDF5 dataspace describes the layout of the elements of a multidimensional array. Conceptually, the array is a hyper-rectangle with one to 32 dimensions. HDF5 dataspace can be extendable. Therefore, each dimension has a current size and a maximum size, and the maximum may be unlimited. The dataspace describes this hyper-rectangle: it is a list of dimensions with the current and maximum (or unlimited) sizes.

#### 10c-6.1.5 Datatype

The HDF5 datatype object describes the layout of a single data element. A data element is a single element of the array; it may be a single number, a character, an array of numbers or carriers, or other data. The datatype object describes the storage layout of this data.

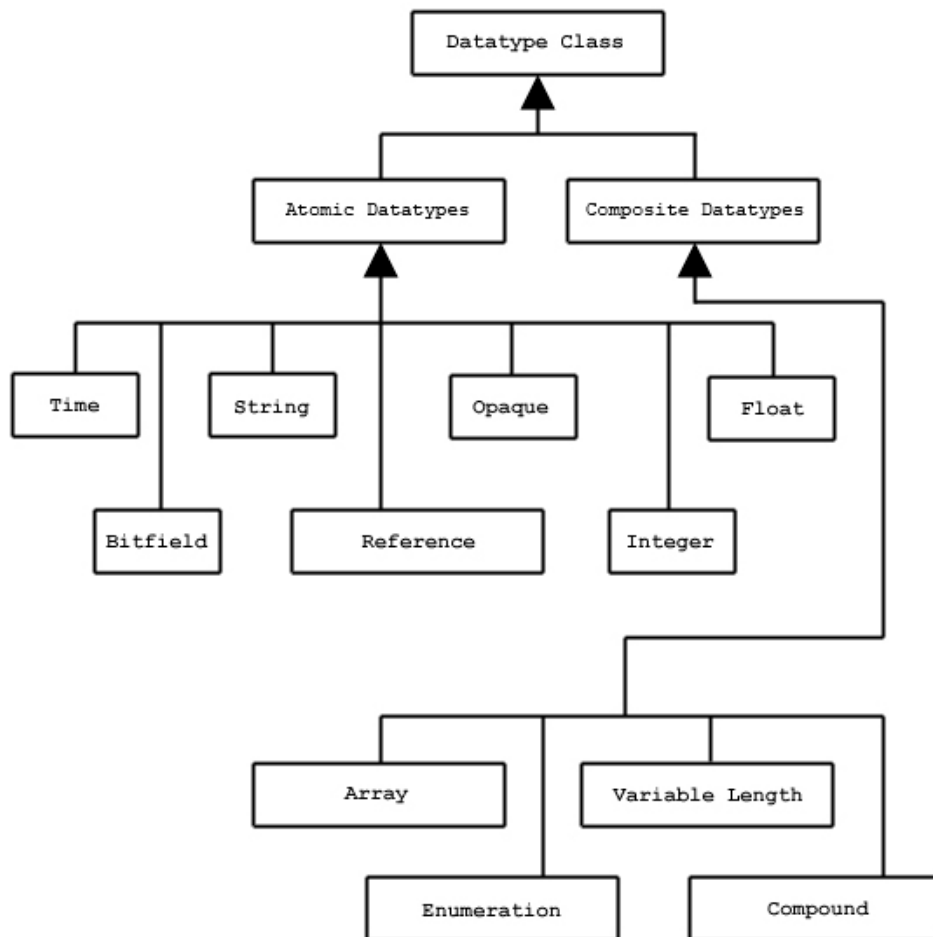
Data types are categorized into 11 classes of datatype. Each class is interpreted according to a set of rules and has a specific set of properties to describe its storage. For instance, floating point numbers have exponent position and sizes which are interpreted according to appropriate standards for number representation. Thus, the datatype class tells what the element means, and the datatype describes how it is stored.

The figure below shows the classification of datatypes. Atomic datatypes are indivisible. Each may be a single object; a number, a string, or some other objects. Composite datatypes are composed of multiple

elements of atomic datatypes. In addition to the standard types, users can define additional datatypes such as a 24-bit integer or a 16-bit float.

A dataset or attribute has a single datatype object associated with it. See the Dataset Figure above. The datatype object may be used in the definition of several objects, but by default, a copy of the datatype object will be private to the dataset.

Optionally, a datatype object can be stored in the HDF5 file. The datatype is linked into a group, and therefore given a name. A *named datatype* can be opened and used in any way that a datatype object can be used.

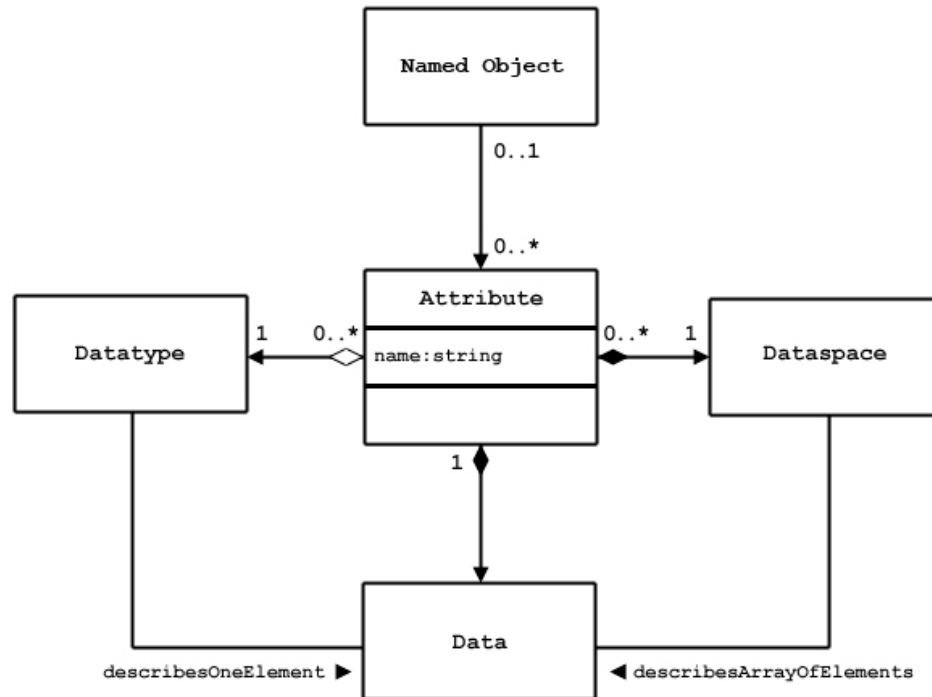


**Figure 5 - Datatype classifications**

### 10c-6.1.6 Attribute

Any HDF5 named data object (group, dataset, or named datatype) may have zero or more user defined attributes. Attributes are used to document the object. The attributes of an object are stored with the object.

An HDF5 attribute has a name and data. The data portion is similar in structure to a dataset: a dataspace defines the layout of an array of data elements, and a datatype defines the storage layout and interpretation of the elements. See the figure below.



**Figure 6 - Attribute data elements**

In fact, an attribute is very similar to a dataset with the following limitations:

- An attribute can only be accessed via the object
- Attribute names are significant only within the object
- An attribute should be a small object
- The data of an attribute must be read or written in a single access (partial reading or writing is not allowed)
- Attributes do not have attributes

Note that the value of an attribute can be an *object reference*. A shared attribute or an attribute that is a large array can be implemented as a reference to a dataset.

The name, dataspace, and datatype of an attribute are specified when it is created and cannot be changed over the life of the attribute. An attribute can be opened by name, by index, or by iterating through all the attributes of the object.

### 10c-6.1.7 Property List

HDF5 has a generic property list object. Each list is a collection of *name-value* pairs. Each class of property list has a specific set of properties. Each property has an implicit name, a datatype, and a value. A property list object is created and used in ways similar to the other objects of the HDF5 library.

Property Lists are attached to the object in the library, they can be used by any part of the library. Some properties are permanent (e.g., the chunking strategy for a dataset), others are transient (e.g., buffer sizes for data transfer). A common use of a Property List is to pass parameters from the calling program to a VFL driver or a module of the pipeline.

Property lists are conceptually similar to attributes. Property lists are information relevant to the behavior of the library while attributes are relevant to the user's data and application. Since the Property List couples the data specification to an implementation use of HDF5 property lists in S-100 Product Specifications is discouraged.

## 10c-6.2 HDF5 Library and Programming Model

The HDF5 Library implements the HDF5 abstract data model and storage model. Two major objectives of the HDF5 products are to provide tools that can be used on as many computational platforms as possible (portability), and to provide a reasonably object-oriented data model and programming interface.

To be as portable as possible, the HDF5 Library is implemented in portable C. C is not an object-oriented language, but the library uses several mechanisms and conventions to implement an object model.

One mechanism the HDF5 library uses is to implement the objects as data structures. To refer to an object, the HDF5 library implements its own pointers. These pointers are called identifiers. An identifier is then used to invoke operations on a specific instance of an object. For example, when a group is opened, the API returns a group identifier. This identifier is a reference to that specific group and will be used to invoke future operations on that group. The identifier is valid only within the context it is created and remains valid until it is closed or the file is closed. This mechanism is essentially the same as the mechanism that C++ or other object-oriented languages use to refer to objects except that the syntax is C.

Similarly, object-oriented languages collect all the methods for an object in a single name space. An example is the methods of a C++ class. The C language does not have any such mechanism, but the HDF5 Library simulates this through its API naming convention. API function names begin with a common prefix that is related to the class of objects that the function operates on. The table below lists the HDF5 objects and the standard prefixes used by the corresponding HDF5 APIs. For example, functions that operate on datatype objects all have names beginning with H5T.

Prefix	Operates on
H5A	Attributes
H5D	Datasets
H5E	Error reports
H5F	Files
H5G	Groups
H5I	Identifiers
H5L	Links
H5O	Objects
H5P	Property lists
H5R	References
H5S	Dataspaces
H5T	Datatypes
H5Z	Filters

**Table 1 - The HDF5 API naming scheme**

Refer the HDF5 User's Guide Release 1.8.8 and the HDF5 Reference Manual 1.8.8 more details on the HDF5 model implementation. S-100 Product Specifications must specify the HDF5 groups, datasets and attributes in context of the S-100 General Feature Model. Appendix A provides an example.

# **S-100 – Part 11**

## **Product Specifications**



## Contents

11-1	Scope .....	1
11-2	References .....	1
11-2.1	Normative .....	1
11-2.2	Informative.....	1
11-3	General structure and content of a data product specification .....	2
11-4	Overview .....	2
11-5	Specification scopes.....	3
11-6	Data product identification.....	4
11-7	Data content and structure.....	5
11-7.1	Feature-based data .....	5
11-7.2	Coverage-based and imagery data.....	6
11-7.3	Coordinate Reference Systems .....	6
11-7.4	Object identifiers.....	6
11-8	Data Quality.....	7
11-9	Data capture and classification .....	8
11-10	Data Maintenance .....	8
11-11	Portrayal .....	9
11-12	Data Product format (encoding) .....	9
11-12.1	Descriptions of GML data formats.....	9
11-13	Data product delivery .....	10
11-14	Additional information.....	10
11-15	Metadata .....	10
Appendix 11-A	Creating an S-100 product specification (informative) .....	11
Appendix 11-B	Example Product Specification (informative).....	14
Appendix 11-C	Introduction to Codelists (informative).....	21
Appendix 11-D	Product Specification Template (informative).....	24

## 11-1 Scope

A data product specification is a precise technical description which defines a geospatial data product. It describes all the features, attributes and relationships of a given application and their mapping to a dataset. It includes general information for data identification as well as information for data content and structure, reference system, data quality aspects, data capture, maintenance, delivery and metadata. It may be created and used on different occasions, by different parties and for different reasons.

This Part of S-100 describes data product specifications for hydrographic requirements for geographic data products. Its aim is to provide a clear and similar structure for any data product specification to be written. This profile shall be in conformance with all the other standards that have been developed within the IHO S-100 Geospatial Standard for Hydrographic Data.

The product specification shall constitute a set of human readable documentation. Generally, it should also include machine readable files for information such as the feature catalogue, the application schema and the CRS parameters. An example of a compliant product specification is shown in Appendix 11-B.

In addition to a 'human readable' document, it is possible to create a machine readable (e.g. XML) summary of the Product Specification. The tables in the sections below indicate the structure for such a summary of the Product Specification.

## 11-2 References

The following referenced documents are required for the application of this document. For dated references, only the edition cited applies. For undated references, the latest edition of the referenced document (including amendments) applies.

### 11-2.1 Normative

ISO 639-2:1998 Codes for the representation of names of languages -- Part 2: Alpha-3 code

ISO 19115:2003 Geographic information – Metadata

ISO 19131:2007 Geographic information – Data product specifications

### 11-2.2 Informative

ISO 8211:1994 Information technology — Specification for a data descriptive file for information interchange

ISO 19104:2004 Geographic information - Terminology

ISO 19106:2004 Geographic information – Profiles

ISO 19109:2005 Geographic information – Rules for application schema

ISO 19123 Geographic information – Schema for Coverage Geometry and Functions

ISO 19136 Geographic information – Geography Markup Language

ISO 19138 Geographic information – Data quality measures

### 11-3 General structure and content of a data product specification

A data product specification defines the requirements for a data product and forms the basis for producing or acquiring data. The data product specification shall contain sections covering the following aspects of the data product.

- a) Overview – see Clause 11-4
- b) Specification scopes – see Clause 11-5
- c) Data product identification – see Clause 11-6
- d) Data content and structure – see Clause 11-7
- e) Reference systems – see Clause 11-7.3
- f) Data quality – see Clause 11-8
- g) Data Capture – see Clause 11-9

NOTE This section can be covered by an encoding guide e.g. for the S-101 ENC product specification - the data capture and classification guide

- h) Data product format – see Clause 11-12
- i) Data product delivery – see Clause 11-13
- j) Metadata – see Clause 11-15

A data product specification may also contain sections covering the following aspects of the data product:

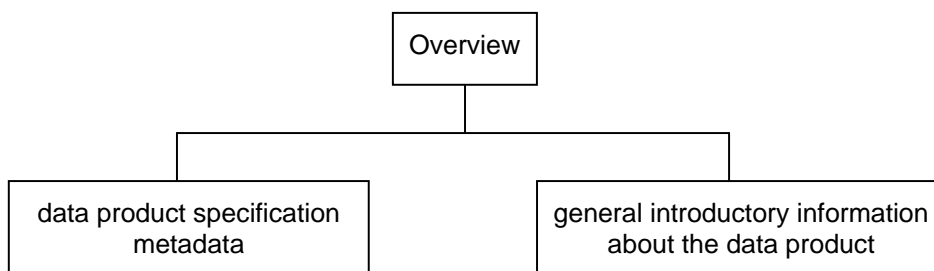
- k) Data Maintenance – see Clause 11-10
- l) Portrayal – see Clause 11-11
- m) Additional Information – see Clause 11-14

Each of these sections of the data product specification is described in the following clauses.

NOTE Sections are adopted from ISO 19131

### 11-4 Overview

The overview section provides a reader of a data product specification with general introductory information about the data product together with product specification metadata.



**Figure 11-1 Content of the Overview Section**

The Overview shall include the following parts:

a) information about the creation of the data product specification;  
 NOTE This shall include the title, a reference date, the responsible party and the language. Information about the maintenance regime for the product specification should also be included.

- b) terms and definitions;
- c) abbreviations;
- d) acronyms for the name of the data product;

EXAMPLE AML Additional Military Layer

e) an informal description of the data product.

The information shall contain general information about the data product which may include the following aspects shown in Table 11-1.

**Table 11-1— Informal Description of the Data Product**

Item Name	Description	Multiplicity	type
title	Official designation of the data product	1	CharacterString
abstract	Informal description of the data product	1	CharacterString
acronym	Any acronyms for the title of the data product	0..*	CharacterString
content	Textual description of the content of any dataset which conform to the specification	1	CharacterString
spatialExtent	Description of the spatial extent covered by the data product	1	EX_Extent (ISO 19115)
temporalExtent	Description of the temporal extent covered by the data product	0..1	EX_Extent (ISO 19115)
specificPurpose	Specific purpose for which the data shall be or has been collected	1	CharacterString

The data product specification metadata shall provide information to uniquely identify the data product specification as well as information about the creation and maintenance of the data product specification. The maintenance description may indicate regular updates, or give contact details for reporting issues which need correction. The data product specification metadata shall include the following items in Table 11-2 [extension to ISO 19131]:

**Table 11-2— Data product specification metadata**

Item Name	Description	Multiplicity	Type
title	Title of the data product specification	1	CharacterString
version	Version of the data product specification	1	CharacterString
date	Date the product specification was created / last updated	1	Date
language	Language(s) of the data product specification, e.g. translations	1..*	CharacterString
classification	Security classification code on the data product specification	0..1	MD_ClassificationCode (ISO 19115)
contact	Party responsible for the data product specification	1	CI_ResponsibleParty (ISO 19115)
URL	Online-address where the resource is downloadable	0..1	URL
identifier	Persistent unique identifier for a published version of the product specification <sup>1</sup> .	1	CharacterString
maintenance	Description of the maintenance regime for the product specification.	1	MD_MaintenanceInformation (ISO 19115)

## 11-5 Specification scopes

Some parts of a product specification may apply to the whole product whereas other parts of the product specification may apply to parts of the product. Coordinate reference system will generally apply to the complete product; whereas maintenance regimes may be different for navigational features and contextual features. If a specification is homogeneous across the whole data product it is only necessary to define a general scope (root scope), to which each section of the data product specification applies. The data product specification may specify a partitioning of the data content of the product on the basis of one or more criteria. Such partitioning may be different for different parts of the data product specification. Each such

<sup>1</sup> This is referenced from the discovery metadata of products which conform to the Product Specification

part of the data content shall be described by a specification scope that may inherit or override the general scope specification.

In principle, any or all of the remaining sections of the product specification may have variants which apply to the scopes within the product. Each variant must identify the scope(s) to which it applies.

**EXAMPLE** Data products to support navigation often contain two sets of feature types: those that provide navigation information that changes rapidly and is essential for safety of navigation, and those that provide background reference information. Maintenance and delivery information would be partitioned on the basis of these groupings; reference system information would not.

This section is only used where different parts of the product (e.g. by theme or geographical extent) have different specifications. For example, some aspects of the specification may be specific to bathymetry, or to non-tidal waters. If this is the case for the product being specified, this section defines the various “scopes” within the overall product specification, and how they should be identified in the datasets.

Depending on the type of data product specification the scope may include items in Table 11-3:

**Table 11-3— Specification Scope Information**

Item Name	Description	Multiplicity	type
scopeIdentification	Specific identification of the scope	1	CharacterString
level	Hierarchical level of the data specified by the scope	0..1	MD_ScopeCode (ISO19115)
levelName	Name of the hierarchy level	0..1	CharacterString
levelDescription	Detailed description about the level of the data specified by the scope	0..1	CharacterString
coverage	Subtype of a feature that represents real world phenomena as a set of attributes	0..1	CharacterString
extent	Spatial, vertical and temporal extent of the data	0..1	EX_Extent (ISO 19115)

## 11-6 Data product identification

This section describes how to identify data sets that conform to the specification. The information identifying the data product may include the following items in Table 11-4. [adopted from ISO 19131]:

**Table 11-4— Identification Information**

Item Name	Description	Multiplicity	type
title	The title of the data product	1	CharacterString
alternateTitle	Short name or other name by which the data product is known	0..1	CharacterString
abstract	Brief narrative summary of the content of the data product	1	CharacterString
topicCategory	The main theme(s) of the data product	0..*	MD_TopicCategoryCode (ISO 19115)
geographicDescription	Description of the geographic area covered by the data product using identifiers	1	EX_GeographicDescription (ISO 19115)

Item Name	Description	Multiplicity	type
spatialResolution	Factor which provides a general understanding of the density of spatial data in the data product	1	MD_Resolution (ISO 19115)
purpose	Summary of the intention with which the data product is developed	1	CharacterString
language	Language(s) of the dataset. If language is not applicable, e.g. for raster data, use "not applicable" as value for the element	1..*	CharacterString (ISO 639-2)
classification	Security classification code on the data product	0..1	MD_ClassificationCode (ISO 19115)
spatialRepresentationType	Form of the spatial representation	0..1	MD_SpatialRepresentationTypeCode (ISO 19115)
pointOfContact	Identification of, and means of communication with, person(s) and organization(s) associated with the data	0..*	CI_ResponsibleParty (ISO 19115)
useLimitation	Limitation affecting the fitness for use of the data product	0..1	CharacterString

## 11-7 Data content and structure

This profile mandates different requirements for data product specifications whether the data is feature- or coverage-based or imagery data. The product specification shall include this information for each identified scope.

### 11-7.1 Feature-based data

The content information of a feature-based data product is described in terms of a general feature model and a feature catalogue [adopted from S-100 Part 3 and S-100 Part 5].

The data product specification shall contain an application schema. For all data product specifications in the realm of S-100, the application schema shall be expressed in UML. All other rules of S-100 Part 3 concerning the creation of the general feature model and especially conformance to ISO 19109:2005 apply as well. If the application schema is a separate document, then the product specification shall include a narrative summary. The product specification shall describe any fixed roles or other restrictions or conventions for default roles. If unique role names are required, it may also define conventions for generating these unique names.

The data product specification shall include a feature catalogue, which provides a full description of each feature type including attributes, attribute values and relationships in the data product. The feature catalogue shall be realized in accordance with S-100 Part 5. The feature catalogue shall be available in both 'machine readable' (e.g. XML based on the S-100 Feature Catalogue XSD) and 'human readable' (e.g. textual derived by XSLT from the XML) forms.

All the feature types, their attributes and attribute value domains, and the association types between feature types expressed in the application schema shall be described in a feature catalogue.

The Product Specification for feature-based scopes shall include the elements in Table 11-5.

**Table 11-5 — Elements of Feature-based data**

Item Name	Description	Multiplicity	type
applicationSchema	The application schema	1	DPS_ApplicationSchema
featureCatalogue	The feature catalogue	1	FC_FeatureCatalogue

### 11-7.2 Coverage-based and imagery data

The content information of a coverage-based data product (including imagery data product) shall be described in accordance with S-100 Part 7. The content information shall be described in the following manner:

A data product specification shall identify each coverage type and each image type that is included within the specification scope and shall provide a narrative description for each. Accordingly, the following components shall be identified to describe a coverage or an image (Table 11-6):

**Table 11-6— Coverage-based and imagery data**

Item Name	Description	Multiplicity	type
coverageID	Unique identifier of coverage	1	CharacterString
coverageDescription	Technical description of the coverage	1	CharacterString
coverageType	Type of the coverage	1	CharacterString
specification	Additional information	1	CV_Coverage (ISO 19123)

### 11-7.3 Coordinate Reference Systems

The data product specification shall include information that defines the reference systems used in the data product. The spatial reference system used shall be a coordinate reference system (CRS) in conformance with S-100 Part 6 CRS Component. The application schema will show how CRS references are carried in the data sets; this may be by reference to a register of CRS parameters, such as the EPSG Geodetic Parameter Dataset.

A product specification may express coordinate operation parameters for operations between particular CRSs. These parameters shall be recorded as described in S-100 Part 6.

**Table 11-7— Reference system identification**

Item Name	Description	Multiplicity	type
spatialReferenceSystem	Reference system identifier(s) of spatial reference system used, e.g. different UTM zones can be considered as different reference systems	1..*	SC_CRS (S-100 Part 6)

### 11-7.4 Object identifiers

The specification of persistent global identifiers for feature and information objects is strongly recommended. Identifiers need not be defined where the physical realities dictate otherwise or it is known that a reference to the object will not be needed, even from an as-yet-unknown external dataset conforming to another product specification. For example, identifiers need not be defined for cartographic objects.

One way to implement persistent global identifiers is by defining a namespace and a persistent unique local identifier for individual feature or information types. The persistent global identifier can be constructed by combining the namespace with the local identifier. Local identifiers must be unique within the namespace for the lifetime of the feature or information object.

The local identifier must be an attribute of feature and information data objects whenever it is defined. The persistent global identifier need not be a data object attribute if the namespace portion can be computed from metadata.

Namespaces may be specified by construction, e.g., a rule describing how to construct a namespace from available metadata. Product Specifications must specify how persistent global identifiers are to be constructed from namespace and local identifiers. It is recommended that the resulting persisting global identifier be a "HTTP URI" (i.e., a URL) or a URN. IETF documents RFC 3986 and RFC 2141 describe the appropriate semantics and structure.

Product Specifications should note that location-based identifiers may not be sufficient to disambiguate data objects, because (for example) two agencies might issue AtoNs in the same area, for example physical buoys marking a channel and a virtual AtoN marking section of the channel with low air draft. Updating and normalizing the data in this case must take into consideration that the two items have similar characteristics (location, aids to navigation, etc), but are different items. Therefore a location based identifier is likely not enough to enable a link between data.

## 11-8 Data Quality

The data product specification shall identify the data quality requirements for each scope within the data product in accordance with S-100 Part 4c. For every data quality scope it is necessary to list all the data quality elements and data quality sub-elements defined in S-100 Part 4c, even if only to state that a specific data quality element or data quality sub-element is not applicable for this data quality scope.

Each product specification shall describe the data quality requirements. One aspect is the "data quality overview element" which should allow a user to decide whether this dataset is the one they want. The other aspect is the metadata allowed for specific feature collections, features and attributes within the dataset.

The data quality overview element should include at least the intended purpose and statement of quality or lineage. Other data quality elements cover: completeness, logical consistency, positional accuracy, temporal accuracy, thematic accuracy, and anything specifically required for the product being specified.

The product specification should comment on which of these are to be used and how, including a description of (or reference to) conformance tests. For example, should data only be published if it passes a particular test, or is it allowable to publish the data with a quality statement which indicates non-conformance? The product specification shall describe how each quality element is to be populated, for example, stating the mechanism to reference the quality evaluation procedure, and allowable values for the quality results.

The application schema shall indicate how the data quality elements will be related to the data items, for example whether a particular dataset should have homogeneous quality, or whether quality elements can be related to feature collections, individual feature objects or attributes.

Finally, the encoding description (clause 15) shall indicate how the quality elements will be encoded.



## 11-9 Data Classification and Encoding Guide

The data product specification shall provide information on how the data is to be captured. This should be as detailed and specific as necessary. The product specification shall include this information for each identified scope.

The product specification includes the collection criteria for mapping real world objects to the conceptual objects of the dataset. Data products can carry information about their data sources (metadata lineage elements); the product specification and application schema will show whether this is expected, and how it is to be done.

Any organization performing data capture for the data product defined by the data product specification shall provide references to any more detailed encoding guide used in addition to that indicated in the product specification for the capturing process.

NOTE A data capture and classification guide is an important part of a data product specification that has to be written before a capturing process can start.

**Table 11-8 — Data capture information**

Item Name	Description	Multiplicity	type
dataSource	Identification of the kinds of data sources usable to product datasets compliant with the considering specification	0..*	CharacterString
productionProcess	Link to a textual description of the production process (including encoding guide) applicable to the datasets compliant with the considering specification	0..*	CharacterString (URL)

## 11-10 Data Maintenance

The data product specification shall provide information on how the data is maintained. It should describe the principles and criteria applied in maintenance decisions, as well as the expected frequency of updates. The product specification shall include this information for each identified scope.

Maintenance information shall also provide procedures regarding how known errors in the data shall be handled. Any organisation performing data maintenance for the data product defined by the data product specification shall provide a reference to the detailed maintenance guide used for the maintenance process. (See also Metadata / Maintenance Information). Information about maintaining the data product specification itself is included in the Overview.

**Table 11-9— Maintenance information**

Item Name	Description	Multiplicity	type
maintenanceAndUpdateFrequency	Frequency with which changes and additions are made to the data product (per update scope)	1..*	MD_MaintenanceInformation (ISO 19115)
dataSource	Identification of the kinds of data sources usable to produce datasets	1..*	LI_Source (ISO 19115)
productionProcess	Textual description of the production process applicable to the datasets (per scope or data source)	1..*	LI_ProcessStep (ISO 19115)

## 11-11 Portrayal

The data product specification may provide information on how the data is to be presented as graphic output, e.g. as a plot or as an image. This is an optional section; however it is strongly recommended that it is included where a product specification defines an IHO navigational product. Where included, this shall take the form of a reference to a portrayal library that contains a set of portrayal rules and a set of portrayal specifications (Table 11-10). The product specification shall include this information for each identified scope.

Classes and attributes required to support portrayal for a particular product need to be registered in a feature catalog dictionary and the feature catalogue for that product specification. Examples could be cartographic object classes, scale maximum / minimum attributes, attributes which suggest layout for textual information (e.g. \$TINTS, \$JUSTH).

The portrayal library shall be defined in accordance with S-100 Part 9.

**Table 11-10— Portrayal Information**

Item Name	Description	Multiplicity	type
portrayalLibraryCitation	Bibliographic reference to the portrayal library	0..1	CI_Citation (ISO 19115)

## 11-12 Data Product format (encoding)

The data product specification shall define the format (encoding) in which each scope within the data product is delivered.

This section includes a description of file structures and format. The file structure (encoding) could be specified completely here, or by reference to a separate profile or standard. For example, S-100 gives guidance on GML (ISO 19136) encoding; a given product would have a specific GML application schema, expressed in one or more XML Schema Definition Language files. Specialized products may use other encodings, for example S-100 contains a profile of ISO 8211 binary encoding.

**Table 11-11 — Data format information**

Item Name	Description	Multiplicity	type
formatName	Name of the data format	1..*	CharacterString
version	Version of the format (date, number, etc.)	0..1	CharacterString
characterSet	Character coding standard used for the dataset (western European requirement, Greek, Turkish, Cyrillic)	1	MD_CharacterSetCode (ISO 19115)
specification	Name of a subset, profile, or product specification of the format	0..1	CharacterString
fileStructure	Structure of delivery file	0..1	CharacterString

### 11-12.1 Descriptions of GML data formats

Documentation of an encoding based on a GML application schema shall include a description of any constraints required. Examples are:

- Whether geometry may be encoded only inline, only by reference, or using either method.
- Any constraints on the order of object types in the dataset, e.g., whether information types must precede spatial and feature data objects.
- Schema locations, namespaces, required imports.

- Whether validation requires methods in addition to XML schema-based validation, and if so, specifications of the validation rules or a permanent Internet location where they are available for download. For example, rule-based validation may be needed for checking the values of conditional attributes.

### 11-13 Data product delivery

The data product specification may define the delivery medium for each identified scope. This is an optional section. If a data product can be delivered in different formats then the appropriate information for each shall be given. Data product delivery and medium information are specified in Table 11-12.

**Table 11-12 — Delivery Medium Information**

Item Name	Description	Multiplicity	type
unitsOfDelivery	Description of the units of delivery (e.g. tiles, geographic areas)	0..1	CharacterString
transferSize	Estimated size of a unit in the specified format, expressed in Mbytes	1	>0
mediumName	Name of the data medium	1	Free text
otherDeliveryInformation	Other information about the delivery	1	Free text

### 11-14 Additional information

This section of the data product specification is optional and may include any other aspects of the data product not provided elsewhere in this specification. Such aspects may include recommended training, creating or using the product, or details of related products. If this information only applies to a part of the data product, then the scope for this must be clearly identified (Table 11-13).

**Table 11-13 — Additional information**

Item Name	Description	Multiplicity	type
additionalInformation	Any additional information to describe the data product	0..1	CharacterString

### 11-15 Metadata

The core metadata elements as defined in ISO 19115 and S-100 Part 4 (Metadata) shall be included with the data product. Discovery and Quality metadata shall be structured as per S-100 Parts 4a and 4c, respectively. Any additional metadata items required for a particular product specification shall be documented in the data product specification. These should be defined using ISO 19115 and ISO 19139, with extensions or restrictions if required. The application schema shall show how metadata is carried in the datasets. This information shall be specified for each identified scope.

### 11-16 Digital Signatures

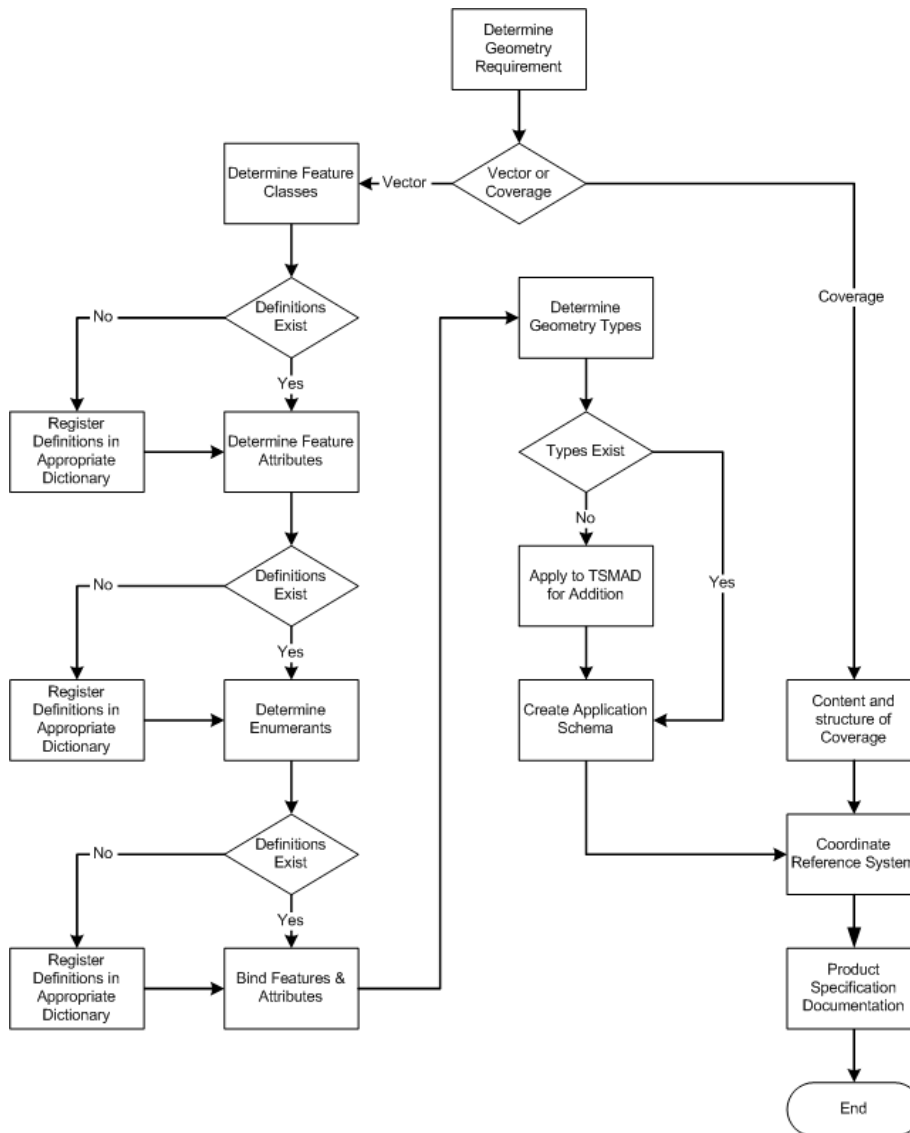
The data product specification may require use of signature to support cyber security. This is an optional section, however it is strongly recommended that it is included where a product specification defines an IHO navigational product. Where included, the details of signature method shall either reference to the IHO S-63 or be described in the product specification itself.

## Appendix 11-A Creating an S-100 product specification (Informative)

### 11-A-1. Introduction

A data product specification is a precise technical description which characterises a geospatial data product. It includes general information for data identification as well as information for data content and structure, reference system, data quality aspects, data capture, maintenance, delivery and metadata.

The process described in this Appendix should be applied to each specification scope identified for the product. For example, if the product will contain a mixture of vector (feature) and coverage data, then the product specification would identify at least two scopes, and the process would be repeated for each scope. If the product contains more than one scope with the same geometry requirement (e.g. two scopes with vector geometry but different application schemas, or different maintenance regimes), then the process could still be followed twice, taking the same route.



**Figure 11-A-1 – Product specification process**

The main reason for creating a data product specification is to define the characteristics of a newly developed data product.

## **11-A-2. General approach**

The general approach to creating an S-100 Based product specification is shown in the process flow diagram in Figure 11-A-1. Further information on the processes is given in the following sections.

### **11-A-2-1. Determine geometry requirement**

The first step is to determine whether the scope will be feature based (i.e. use vector geometry) or coverage-based. Certain aspects of a product specification apply only to feature-based data and certain aspects apply only to coverage-based data. A product specification may include both feature-based and coverage-based data, by using specification scopes.

## **11-A-3. Feature-based product**

### **11-A-3-1. Determine feature attributes**

Determine which feature attributes are required in the product. Seek definitions in existing authoritative feature data dictionaries. If required definitions do not exist then define new feature attributes.

### **11-A-3-2. Determine enumerates**

Determine which enumerates are required in the product. Seek definitions in existing authoritative feature data dictionaries. If required definitions do not exist then define new enumerates.

### **11-A-3-3. Register definitions in appropriate dictionary**

If new definitions are required then seek to register them in the most appropriate feature concept dictionary. The IHO will hold one such dictionary. The S-100 Feature Catalogue component does allow for feature or attribute types to be defined locally, if it is not possible to register them in an external dictionary.

### **11-A-3-4. Bind features and attributes**

Features and attributes that are defined in a feature concept dictionary shall be bound in a feature catalogue.

### **11-A-3-5. Determine geometry types**

Determine which geometry types are required in the product. S-100 includes definitions of 1D and 2D geometry types. If a geometry type is required that is not specified in S-100 Part 7 Spatial Component, then apply to S-100WG for it to be added to the framework.

### **11-A-3-6. Create application schema**

It is possible to express an application schema in two different ways:

Using a conceptual schema language (a logical model)

Using an encoding specific language (a physical model)

**EXAMPLE** An example of a conceptual schema language is the UML. An example of an encoding specific language is XML Schema Definition Language.

An S-100 application schema may be expressed using the UML. The resulting model shall be included in the Product Specification so that the logical organisation of the data can be visualised easily. This will be particularly helpful where features have complex structures or relationships. An introduction to UML is included in the S-100 Main Document.

In some cases it is possible to generate the physical application schema automatically from the logical application schema.

**EXAMPLE** GML is an XML grammar for encoding geographic information. GML application schemas are written using XML Schema Definition Language which is itself a form of XML. Specific rules for designing GML application schemas using UML Class Diagrams are presented in ISO 19136 (the ISO/TC 211 standard for GML). The UML has a standard XML encoding that can be used for interchange of UML models between UML packages. Therefore, if the ISO 19136 rules for designing GML application schemas using UML are adhered to it is possible to export the resulting UML model as XML and to transform the resulting XML to the XML encoding of a GML application schema. The transformation between the UML XML and the GML application schema XML may be undertaken with an XML Stylesheet. Tools have been created that accomplish this task.

Physical encoding mechanisms may define means by which the physical application schema can be used to validate data instances that claim conformance with the application schema in an automatic way.

**EXAMPLE** GML schemas can be used for a certain amount of dataset validation. The feature and attribute definitions, referenced from the dictionaries, can be presented to the users. GML application schemas are written in XML Schema Definition Language. This is capable of expressing simple constraints, e.g. minimum and maximum values, character patterns. It is not capable of directly expressing constraints which involve more than one property type (e.g. "if there is more than one value of 'colour', 'colour pattern' must be set"). If these are included in the Application Schema, perhaps in a formal language such as Object Constraint Language, the ISO 19136 rules ignore them. Thus the GML schema associated with a given product can only be used for a limited validation.

#### **11-A-4. Coverage based product**

##### **Content and structure of the coverage**

The content and structure of a coverage-based product shall be described in terms defined by ISO 19123.

#### **11-A-5. Coordinate Reference System**

Determine the appropriate CRS for the data product. More than one CRS may be specified. If necessary, define coordinate operation methods and parameters that shall be used in conjunction with the data product.

## Appendix 11-B

### Example Product Specification (Informative)

#### 11-B-1. Overview

##### 11-B-1-1. Product specification metadata

Title		Tide Prediction Information Product Specification
Version		1.0
Date		Created: 2008-01-18
Language		English
Classification		Unclassified
Contact	Organisation Name	Data Product Owner
	Role	Owner
Identifier		IHO:S100:PSExample1
Maintenance		Every five years

##### 11-B-1-2. Product description

Name		Tide Prediction Information
Abstract		Encodes information and parameters for use in making tide predictions
Content		A conformant dataset may contain features associated with the prediction of tides. The specific content is defined by the Feature Catalogue and the Application Schema.
Spatial Extent	Description	Global, marine areas only
	East Bounding Longitude	180
	West Bounding Longitude	-180
	North Bounding Latitude	90
	South Bounding Latitude	-90
Specific Purpose		The data shall be collected for the purpose of tide prediction.

##### 11-B-1-3. Specification scope

This product specification defines only one general scope which applies to all its sections.

Scope Identification	GeneralScope
Level Name	General Scope

**11-B-1-4. Data product identification**

Title		Tide Prediction Information
Abstract		Encodes information and parameters for use in making tide predictions
Geographic Description	Description	Global, marine areas only
	East Bounding Longitude	180
	West Bounding Longitude	-180
	North Bounding Latitude	90
	South Bounding Latitude	-90
Spatial Resolution	Equivalent Scale	10000
Purpose		The data shall be collected for the purpose of tide prediction.
Language		Not applicable

Data Product Identification Scope: GeneralScope

**11-B-2. Data content and structure****Introduction**

TPI is a feature-based product. This section contains a feature catalogue and an application schema which is expressed in UML.

**Feature Catalogue**

**Name:** Tide Prediction Information Feature Catalogue  
**Scope:** Catalogue containing features associated with the prediction of tides.  
**Field of application:** Marine navigation  
**Version Number:** 1.0  
**Version Date:** May 2009  
**Producer:** International Hydrographic Organization  
**Functional Language:** English

**Feature Type**

**Name:** Tide Prediction  
**Definition:** Method for calculating tidal motion.  
**CamelCase:** TidePrediction  
**Remarks:** -  
**Alias:** -

**Feature Attributes**

**Name:** Object Name  
**Attribute Type:** Simple  
**Definition:** The individual name of an object.  
**CamelCase:** objectName  
**Cardinality:** 0..1



**Data Type:** text

**Name:** National Object Name

**Attribute Type:** Simple

**Definition:** The individual name of an object in the national Language.

**CamelCase:** nationalObjectName

**Cardinality:** 0..1

**Data Type:** text

**Name:** Status

**Attribute Type:** Simple

**Definition:** The geometric primitive of the associated feature

**camelCase:** status

**Cardinality:** 1

**Data Type:** Enumeration

**Values:**

- 1: Permanent
- 2: Occasional
- 3: Recommended
- 4: Not in use
- 5: Periodic/intermittent
- 6: Reserved

**Name:** Method of Tidal Prediction

**Attribute Type:** Simple

**Definition:** The technique employed to calculate tidal predictions

**camelCase:** methodOfTidalPrediction

**Cardinality:** 1

**Data Type:** Enumeration

**Values:**

- 1: Simplified harmonic
- 2: Full harmonic
- 3: Time and height difference

#### Feature Type

**Name:** Tide Harmonic Prediction

**Definition:**

**camelCase:** TideHarmonicPrediction

**Remarks:** -

**Alias:** -

#### Feature Attributes

**Name:** Value Of Harmonic Constituents

**Attribute type:** Complex

**Definition:**

**camelCase:** valueOfHarmonicConstituents

**Cardinality:** 1

**Data Type:** Harmonic Constituent

**Name:** Harmonic Constituent

**Attribute type:** Complex  
**Definition:** One of the harmonic elements in a mathematical expression of the tide- producing force, and in corresponding formulae for the tide or tidal stream. Each constituent represents a periodic change of relative position of the Earth, Sun and Moon.  
**CamelCase:** harmonicConstituent  
**Cardinality:** 1..\*

**Sub Attributes**

**Name:** CategoryOfHarmonicConstituents  
**Attribute Type:** Simple  
**Data Type:** Enumeration  
**Values:**  
                   1: M2  
                   2: S2  
                   3:MM

**Name:** Constituent Amplitude  
**Definition:** The amplitude of a tidal constituent for a given place in metres  
**Attribute Type:** Simple  
**Data Type:** Real

**Name:** Constituent Phase  
**Definition:** The phase lag of a tidal constituent at a particular place in degrees  
**Attribute Type:** Simple  
**Data Type:** Real

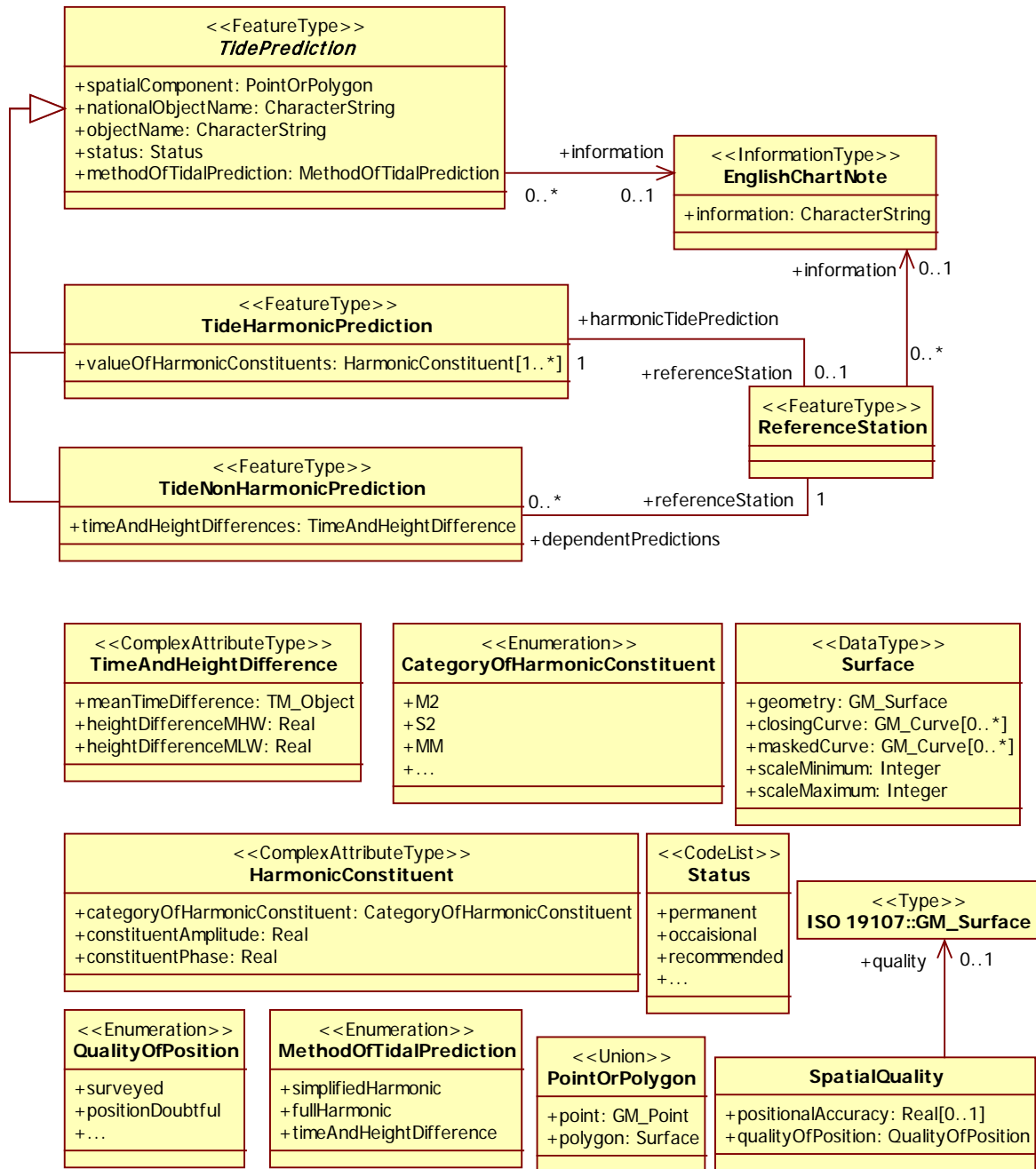
**Feature Type**

**Name:** Tide Non Harmonic Prediction  
**Definition:** method of tidal prediction made by applying the times of the moon's transits to the mean height of the tide systems of differences to take account of average conditions and various inequalities due to changes in the phase of the moon, declination and parallax of the moon and sun.  
**camelCase:** TideNonHarmonicPrediction  
**Remarks: -**  
**Alias: -**

**Name:** English Chart Note  
**Definition:** Textual information calling special attention to some fact.  
**CamelCase:** EnglishChartNote  
**Remarks: -**  
**Alias: -**

**Name:** Reference Station  
**Definition:** Station at which the tidal observations were made.  
**CamelCase:** ReferenceStation  
**Remarks: -**  
**Alias: -**

**Application Schema**



**Figure 11-B-1 – Application schema**

### 11-B-3. Data Content and Structure Scope: GeneralScope Coordinate Reference System

Geodetic Coordinate Reference System		
name	code	WGS 84
scope		Horizontal component of the 3D geodetic CRS used by the GPS satellite system.
Geodetic Datum		
scope		Satellite navigation.
Ellipsoid	semiMajorAxis	6378137m
	inverseFlattening	298.257223563
primeMeridian	greenwichLongitude	0°
Ellipsoidal Coordinate System		
Axis 1		
name	code	Geodetic latitude
axisSymbol		Lat
axisDirection		north
unitOfMeasure		angle
Axis 2		
name	code	Geodetic longitude
axisSymbol		Long
axisDirection		east
unitOfMeasure		angle

Coordinate Reference System Scope: GeneralScope

#### 11-B-4. Data Quality

Data Quality Scope: GeneralScope

#### 11-B-5. Data Capture

##### Data source

Tidal predictions are based on a proprietary mathematical model

##### Production Process

A data set conforming to this product specification shall cover an extent of one degree by one degree. Features with surface geometry that cross the edge of product cells shall be split and their geometry shall be specified in the following way, using the class Surface:

Geometry	The polygon geometry specified as the ISO 19107 type GM_Surface
Closing Curve	The segment of the edge of the polygon geometry that coincides with the

	edge of the cell specified as the ISO 19107 type GM_Curve
Masked Curve	The segment of the edge of the polygon geometry that does not coincide with the edge of the cell specified as the ISO 19107 type GM_Curve

Data Capture Scope: GeneralScope

### 11-B-6. Data Maintenance

Data are updated as deemed necessary.

Data Maintenance Scope: GeneralScope

### 11-B-7. Data Product Format

#### Delivery format

Format name	Geography Markup Language
Version	3.1.1
Specification	Geography Markup Language – GML – 3.0, OpenGIS® Implementation Specification, 7 February 2004, OGC Document Number 03-105r1
Language	English
Character Set	utf8

### 11-B-8. Data Product Delivery

#### Delivery medium

Medium Name	Compact Disc (CD)
-------------	-------------------

Data Product Delivery Scope: GeneralScope

### 11-B-9. Additional Information

Not applicable

### 11-B-10. Metadata

Not Applicable

## Appendix 11-C Guidance on Codelists (informative)

### 11-C-1. Introduction to Codelists

Product specifications should balance all relevant considerations, e.g., implementation costs, application operational environment, cross-domain reuse, and reduction of maintenance and distribution efforts, when deciding which approach to use for any particular attribute.

### 11-C-2. Modelling

When deciding between using a codelist and enumeration, consider the completeness, stability, source, reuse, and application dependencies of the list of values.

- If the set of allowed values is fixed and reasonably short (say, fewer than 20 values?), an enumeration must be used.
- If the list is fixed but long, an enumeration is preferred but a “dictionary model” codelist may be used.
- If only the likely values of an enumeration are known, or the list may be extended by data producers or the user community, a codelist must be used. Whether the “dictionary” or “open” form is preferable depends on who might add values – if it is maintained by an organization, the dictionary form is preferable, if user communities or data producers may add values, the “open” form is preferable.
- If the allowed values change frequently and the list should be updated without major revisions of the product specification, a codelist may be used. The “dictionary” form may be preferable under these circumstances.
- If application logic or portrayal rules depend on values, an enumeration is preferred but a codelist may be used if the logic/rules can be written to cover all possible values (e.g., using wildcards or defaults), or otherwise allow graceful recovery from unanticipated values.
- Collections which have internal structure (e.g., types and subtypes of vessels) should be modelled as “dictionary” codelists, pending discussion of the matter by ISO TC211.

#### Hierarchies of codelists

A codelist may also be used as a super-type for more specific codelists. The vocabulary of the super-type is the union of the vocabularies of its sub-types<sup>2</sup>. If additional values are permitted the super-type must be an “open enumeration” or “open dictionary” codelist. Practically, this allows vocabularies developed by different domain expert groups or organizations to be merged.

### 11-C-3. Codelists maintained by external organizations

If there is an existing well-established codelist maintained by a responsible source, it can be referenced in an application schema. The codelist should meet the following requirements<sup>3</sup>:

- It must be managed by a responsible source – an official national or international standards body, long-established user community, group, or consortium.
- The codelist and its values must be identified by persistent HTTP URIs.
- The list should be well-maintained i.e. all its values must remain available forever, even if they have been deprecated, retired or superseded.
- The list should be in a dictionary language accepted for use in S-10x product specifications.

<sup>2</sup> Note that the super-type cannot augment the union set with additional definitions. This conforms to the INSPIRE usage but it may be reconsidered if such augmentation is required at a later time.

<sup>3</sup> Adapted from INSPIRE guidelines.

The IHO may be requested to arrange for the translation, reproduction, and maintenance of codelists meeting only some of the above requirements. Note that this may necessitate a discussion between the IHO and the source.

#### 11-C-4. Data formats of codelist typed attributes

The codelist model in S-100 is designed to be flexible by decoupling application schema from data format to some extent. Data formats may use “codelist extractions” created by extracting codes or values from a codelist dictionary and treat them as ordinary enumerations. The effect is to allow data formats to use either an external dictionary or ordinary enumerations. For example, an XML data format might convert an *ISO3166CountryCodes* codelist maintained by IHO into an XML Schema type:

```
<xs:simpleType name="ISO3166CountryCodesType">
  <xs:restriction base="xs:string">
    <xs:enumeration value="EN"/>
    <xs:enumeration value="FR"/>
    ... other country codes ...
```

As far as implementations using that schema are concerned, it is indistinguishable from an ordinary enumeration. The decision as to which alternative(s) to use in any particular product specification should depend on the circumstances of the data product and its use environment. The decision should be made by the product specification authors when developing the data format. Obviously allowing different data formats to use different representations introduces additional maintenance requirements relating to some data formats, these would be limited to the formats which use “closed” representations (i.e., convert the codelist to an ordinary enumeration).

##### 11-C-4-1. GML and other XML data formats

Enumeration with pattern: The data format in XML schemas must conform to ISO 19136 E.2.4.9, i.e., a union of an enumeration and a pattern of the form:

```
other: [a-zA-Z0-9]+( [a-zA-Z0-9]+)*
```

Examples of use (assuming a codelist which explicitly lists “Norwegian” but not Nynorsk and Bokmål):

```
<language>nor</language>      <!-- Norwegian is an enumerated value -->
-->
<language>other: nno</language> <!-- Norwegian Nynorsk is not an
enumerated value -->
```

External Dictionary: The data format in XML schemas must be the XML Schema built-in types *anyURI*. The use of spaces is discouraged.

Example: (UN/LOCODEs, United Nations Code for Trade and Transport Locations)

In XML schema: Type definition:

```
<xs:simpleType name="unLoCodeType" type="xs:anyURI">
```

and later (in the feature definition):

```
<xs:element name="unLoCode" type="unLoCodeType"/>
```

In a dataset:

```
<unLoCode
xlink:href="http://registry.iho.int/codelists/locode/2013/1/USNYC"/>
```

for New York City, identified by code “US NYC” in the UN/LOCodelist version 2013-1 (published July 2013).

### 11-C-4-2. ISO 8211 encodings

Enumeration with pattern: To accommodate producer-defined values (“other: xyz”) this can be encoded either as a “text” type (character string) or as a complex attribute with an integer sub-attribute (for the listed allowed values) and a text sub-attribute (the “other:...” values).

External Dictionary: This can be encoded in two ways:

1. A URI data type with value a URI constructed by combining the URI for the vocabulary (dictionary) and the item code. E.g.,  
`http://registry.ihc.int/codelists/locode/2013/1/USNYC` for New York City (in the July 2013 edition of UN/LOCODEs list).
2. A complex attribute with two sub-attributes: Vocabulary location (URI) and item code (text). To use the same example: sub-attributes are *vocabulary=*  
`http://registry.ihc.int/codelists/locode/2013/1/` and  
*itemCode=USNYC*.

The first method is recommended as it reduces data complexity.

### 11-C-5. Dictionary formats

Use of GML dictionary or SKOS format is recommended. Other formats may be considered under compelling circumstances or after the development of standards in ISO or elsewhere.

### 11-C-6. Dictionary distribution and discovery

In order to remove dependence on Internet connectivity for interpreting codelist values, codelist dictionaries may be distributed as support files in exchange sets. For the purposes of distribution, discovery, management of updates, and version control, such local dictionary files can be treated as ordinary support files. Discovery metadata for support files is described in Part 4a (see class S100\_SupportFileDiscoveryMetadata).

#### 11-C-6-1. Entity resolution with local dictionary files

If mappings from namespaces to dictionary files are needed for a data product, the use of a catalogue file is suggested in which case the product specification may specify the catalogue file name and format. The catalogue file itself can be treated as another support file, having a fixed filename and location in the exchange set which are stated in the product specification.

**Example:** A product specification uses XML catalogues for resolving codelist namespaces to local dictionary files. It specifies that the catalogue file shall conform to the OASIS standard for XML catalogues (“XML Catalogs V. 1.1”),

URL: <https://www.oasis-open.org/standards#xmlcatalogsv1.1>). The product specification standardizes the name of the catalogue file as CODELSTCAT.XML.



## **Appendix 11-D**

### **Product Specification Template**

(informative)

#### **Introduction**

**The following annex is a template for builders of S-100 based product specifications. The word version of the template is available at [www.iho.int](http://www.iho.int),**

# **S-100 – Part 12**

## **S-100 Maintenance Procedures**

## Contents

12-1	Scope .....	1
12-2	Maintenance Procedures .....	1
12-2.1	Clarification.....	1
12-2.2	Revision.....	1
12-2.3	New Edition .....	1
12-3	Version Control.....	2
12-3.1	Clarification Version Control.....	2
12-3.2	Revision Version Control.....	2
12-3.3	New Edition Version Control .....	2
Appendix 12-A	S-100 Maintenance – Change Proposal Form (normative) .....	3

## 12-1 Scope

As users begin to implement S-100 and associated product specifications, errors and deficiencies in S-100 may be found and these will need to be handled in a uniform manner. This Part specifies procedures to be followed in updating, maintaining and publishing the various parts of S-100. It excludes the maintenance of the S-100 registry, as each register manager will have their own specific procedures for updating their register(s). Additionally, this Part excludes the maintenance regime of product specifications. However, S-100 versions must be backward compatible to ensure interoperability of product specifications.

NOTE All S-100 based product specifications shall include a maintenance section.

## 12-2 Maintenance Procedures

Change proposals for S-100 are coordinated by S-100WG and shall be made available via the IHO web site. Organizations that wish to make changes to S-100 must address their change proposals to the International Hydrographic Bureau.

Changes to S-100 are classified at one of three different levels: *new edition*, *revision*, or *clarification*. In each case, the development, consultation and approval process will be slightly different, ranging from a very comprehensive regime for *new editions*, to approval at the level of a subordinate body for *clarifications*. *New editions* and *revisions* are considered to be “significant changes” for the purposes of review, consultation and approval.

All proposed changes shall be technically and commercially assessed before approval. All proposals shall be submitted to the secretary S-100WG using the S-100 Maintenance - Change Proposal Form in Appendix 12-A (normative).

Changes to IHO technical standard S-100 shall be subject to the terms of Resolution 2/2007.

### 12-2.1 Clarification

Clarifications are non-substantive changes to S-100. Typically, *clarifications*: remove ambiguity; correct grammatical and spelling errors; amend or update cross references; insert improved graphics in spelling, punctuation and grammar. A clarification must not cause any substantive semantic change to S-100. *Clarifications* are the responsibility of the relevant subordinate body and may be delegated to the responsible editor.

### 12-2.2 Revision

*Revisions* are defined as substantive semantic changes to S-100. Typically, *revisions* change existing specifications to correct factual errors; introduce necessary changes that have become evident as a result of practical experience or changing circumstances; or add new specifications within an existing section. *Revisions* could have an impact on either existing users or future users of a revised standard. It follows that a full consultative process that provides an opportunity for input from as many stakeholders as possible is required. Proposed changes to S-100 should be evaluated and tested wherever practicable. The approval of Member States is required before any *revisions* to S-100 can enter into force. All cumulative *clarifications* must be included with the release of approved corrections revisions.

A *revision* shall not be classified as a *clarification* in order to bypass the appropriate consultation processes.

### 12-2.3 New Edition

*New Editions* of S-100 introduce significant changes. *New Editions* enable new concepts, such as the ability to support new functions or applications, or the introduction of new constructs or data types, to be introduced. *New Editions* are likely to have a significant impact on either existing users or future users of the revised standard. It follows that a full consultative process that provides an opportunity for input from as many stakeholders as possible is required. Proposed changes to S-100 should be evaluated and tested wherever practicable. The approval of Member States is required before any *New Edition* of S-100 can enter into force. All cumulative *clarifications* and *revisions* must be included with the release of an approved *New Edition* of S-100.

## **12-3 Version Control**

The IHO shall release new versions of S-100 as necessary. New versions shall include *clarifications*, *revisions* and *new editions*. Each version shall contain a change list that identifies the changes between versions of S-100.

### **12-3.1 Clarification Version Control**

Clarifications shall be denoted as  $n.n.n$ . Each clarification or set of clarifications approved at a single point in time shall increment  $n$  by 1.

### **12-3.2 Revision Version Control**

Revisions shall be denoted as  $n.n.0$ . Each revision or set of revisions approved at a single point in time shall increment  $n$  by 1. Revision version control shall set clarification version control to 0.

### **12-3.3 New Edition Version Control**

New Editions shall be denoted as  $n.0.0$ . Each new edition approved at a single point in time shall increment  $n$  by 1. New Edition version control shall set the clarification and revision version control to 0.

## Appendix 12-A

### S-100 Maintenance - Change Proposal Form (normative)

---

Organization

Date

Contact

Email

#### Change Proposal Type *Select only one option*

1. Clarification

2. Revision

3. New Edition

#### Location *Identify all change proposal locations*

S-100 Version No.

Part No.

Section No.

Proposal Summary

#### Change Proposal

*Please provide a detailed change proposal.*

#### Change Proposal Justification

*Please provide a suitable explanation for the change and where applicable supporting documentation.*

**Please send completed forms and supporting documentation to the International Hydrographic Bureau (addt@iho.int).**

# **S-100 – Annex A**

## **Terms and Definitions**

# ANNEX A

## Terms and definitions

For the purposes of this document, the following terms and definitions apply:

### 2.5 dimension

Two-dimensional topology used with a three-dimensional coordinate system constrained to a two-dimensional manifold [ISO 19107]

### abstract class

an abstract class defines a polymorphic object class which cannot be instantiated [ISO 19103]

### accuracy

closeness of agreement between a test result and the accepted reference values [ISO 3534-1]

NOTE A test result can be from an observation or measurement.

### addition

insertion of an item into the register [ISO 19135]

### affine coordinate system

coordinate system in Euclidean space with straight axes that are not necessarily mutually perpendicular [ISO 19111]

### aggregation

special form of association that specifies a whole-part relationship between the aggregate (whole) and a component part (see composition) [ISO 19103]

### annotation

any marking on illustrative material for the purpose of clarification

NOTE Numbers, letters, **symbols**, and signs are examples of annotation.

[ISO 19117:2012 (E), 4.1]

### application schema

Conceptual schema for data required by one or more applications [ISO 19101]

### association

semantic relationship between two or more classifiers that specifies connections among their instances [ISO 19103]

NOTE A binary association is an association among exactly two classifiers (including the possibility of an association from a classifier to itself).

### attribute

(1) named property of an entity [ISO/IEC 2382-17:1999]

NOTE Describes a geometrical, topological, thematic, or other characteristic of an entity

(2) feature within a classifier that describes a range of values that instances of the classifier may hold

NOTE 1 An attribute is semantically equivalent to a composition association; however, the intent and usage is normally different.

NOTE 2 "Feature" used in this definition is the UML meaning of the term and is not meant as defined in clause 4 of this part.

### band

range of wavelengths of electromagnetic radiation that produce a single response by a sensing device [ISO/TS 19101-2:2008]

### base standard

ISO geographic information standard or other information technology standard that is used as a source from which a profile may be constructed [ISO 19106:2005]



**boundary**

set that represents the limit of an entity [ISO 19107]

NOTE Boundary is most commonly used in the context of geometry, where the set is a collection of points or a collection of objects that represent those points.

**cartesian coordinate system**

coordinate system which gives the position of points relative to  $n$  mutually perpendicular axes [ISO 19111]

**clarification**

non-substantive change to a register item [ISO 19135]

NOTE A non-substantive change does not change the semantics or technical meaning of the item. A clarification does not result in a change to the registration status of the register item.

**class**

description of a set of objects that share the same attributes, operations, methods, relationships, and semantics [ISO/TS 19103:2005]

NOTE 1 A class represents a concept within the system being modelled. Depending on the kind of model, the concept may be real-world (for an analysis model), or it may also contain algorithmic and computer implementation concepts (for a design model). A classifier is a generalization of class that includes other class-like elements, such as data type, actor and component.?

NOTE 2 A class may use a set of interfaces to specify collections of operations it provides to its environment. See: interface.

**classification**

The process of determining the appropriate type within a feature catalogue for a particular real world feature, including consideration of data quality.

**classifier**

mechanism that describes behavioural and structural features [ISO 19103]

NOTE Classifiers include interfaces, classes, datatypes, and components.

**code list**

Value domain including a code for a permissible value [ISO 19136]

**composite curve**

sequence of curves such that each curve (except the first) starts at the end point of the previous curve in the sequence [ISO 19107]

**composition**

form of aggregation association with strong ownership and coincident lifetime as part of the whole [ISO 19103]

NOTE Parts with non-fixed multiplicity may be created after the composite itself, but once created they live and die with it (i.e., they share lifetimes). Such parts can also be explicitly removed before the death of the composite. Composition may be recursive. Synonym: composite aggregation.

**compound coordinate reference system**

coordinate reference system using at least two independent coordinate reference systems [ISO 19111]

**concatenated coordinate operation**

coordinate operation consisting of sequential application of multiple coordinate operations [ISO 19111]

**conceptual model**

model that defines the concepts of a universe of discourse [ISO 19101]

**conceptual schema**

formal description of a conceptual model [ISO 19101]

**conformance**

fulfilment of specified requirements [ISO 19105]

**continuous coverage**

coverage that returns different values for the same feature attribute at different direct positions within a single geometric object in its spatiotemporal domain [ISO 19123]

NOTE Although the spatiotemporal domain of a continuous coverage is ordinarily bounded in terms of its spatial extent, it can be subdivided into an infinite number of direct positions.

**control body**

group of technical experts that makes decisions regarding the content of a register [ISO 19135]

**coordinate**

one of a sequence of  $n$  numbers designating the position of a point in  $N$ -dimensional space [ISO 19111]

NOTE The numbers must be qualified by units.

**coordinate conversion**

coordinate operation in which both coordinate reference systems are based on the same datum [ISO 19111]

**coordinate operation**

change of coordinates, based on a one-to-one relationship, from one coordinate reference system to another [ISO 19111]

**coordinate reference system**

A coordinate system that is related to the real world by a datum [ISO 19111]

NOTE For geodetic and vertical datums, it will be related to the Earth.

**coordinate system**

set of mathematical rules for specifying how coordinates are to be assigned to points [ISO 19111]

**coordinate transformation**

coordinate operation in which the two coordinate reference systems are based on different datums [ISO 19111]

**coordinate tuple**

ordered list of coordinates

**coverage**

feature that acts as a function to return values from its range for any direct position within its spatial, temporal or spatiotemporal domain [ISO 19123:2005]

EXAMPLE Examples include a raster image, polygon overlay, or digital elevation matrix

**coverage geometry**

configuration of the domain of a coverage described in terms of coordinates [ISO 19123]

**curve**

1-dimensional geometric primitive, representing the continuous image of a line [ISO 19107]

NOTE The boundary of a curve is the set of points at either end of the curve. If the curve is a cycle, the two ends are identical, and the curve (if topologically closed) is considered to not have a boundary. The first point is called the start point, and the last is the end point. Connectivity of the curve is guaranteed by the "continuous image of a line" clause. A topological theorem states that a continuous image of a connected set is connected.

**curve segment**

1-dimensional geometric object used to represent a continuous component of a curve using homogeneous interpolation and definition methods [ISO 19107]

NOTE The geometric set represented by a single curve segment is equivalent to a curve.

**cycle**

Spatial object without a boundary [ISO 19107]

NOTE Cycles are used to describe boundary components (see ring). A cycle has no boundary

because it closes on itself, but it is bounded (i.e., it does not have infinite extent). A circle or a sphere, for example, has no boundary, but is bounded.

**data**

reinterpretable representation of information in a formalised manner suitable for communication, interpretation, or processing [ISO/IEC 2382-1:1993]

**data capture and classification guide**

Instructions describing the data capturing process and the process of classification

**data compaction**

reduction of the number of data elements, bandwidth, cost, and time for the generation, transmission, and storage of data without loss of information by eliminating unnecessary redundancy, removing irrelevancy, or using special coding [ANS T1.523-2001]

NOTE Whereas data compaction reduces the amount of data used to represent a given amount of information, data compression does not.

**data compression**

compression: reduction in the number of bits used to represent source image data [ISO 10918-1 (JPEG Part 1)]

NOTE Data compression does not reduce the amount of data used to represent a given amount of information, whereas data compaction does. Both data compression and data compaction result in the use of fewer data elements for a given amount of information.

**data product**

A dataset or dataset series that conforms to a data product specification [ISO 19131]

**data product specification**

A detailed description of a dataset or dataset series together with additional information that will enable it to be created, supplied to and used by another party [ISO 19131]

NOTE A data product specification provides a description of Hydrographic Concepts and a specification for mapping the universe of discourse to a dataset. It may be used for production, sales, end-use or other purposes.

**data quality date**

date or range of dates on which a data quality measure is applied [ISO 19113]

**data quality element**

quantitative component documenting the quality of a dataset [ISO 19101]

NOTE The applicability of a data quality element to a dataset depends on both the dataset's content and its product specification, the result being that all data quality elements may not be applicable to all datasets

**data quality evaluation procedure**

operations used in applying and reporting quality evaluation methods and their results [ISO 19113]

**data quality measure**

evaluation of a data quality subelement [ISO 19113]

EXAMPLE The percentage of the values of an attribute that are correct.

**data quality overview element**

non-quantitative component documenting the quality of a dataset [ISO 19101]

NOTE Information about the purpose, usage and lineage of a dataset is non-quantitative quality information.

**data quality result**

value or set of values resulting from applying a data quality measure or the outcome of evaluating the obtained value or set of values against a specified conformance quality level [ISO 19113]

EXAMPLE A data quality result of "90" with a data quality value type of "percentage" reported for the data quality element and its data quality subelement "completeness, commission" is an example of a value resulting from applying a data quality measure to a data specified by a data quality scope. A data quality result of "true" with a data quality value type of "Boolean variable" is an example of

comparing the value (90) against a specified acceptable conformance quality level (85) and reporting an evaluation of a kind, pass or fail.

**data quality scope**

extent or characteristic(s) of the data for which quality information is reported [ISO 19113]

NOTE A data quality scope for a dataset can comprise a dataset series to which the dataset belongs, the dataset itself, or a smaller grouping of data located physically within the dataset sharing common characteristics. Common characteristics can be an identified feature type, feature attribute, or feature relationship; data collection criteria; original source; or a specified geographic or temporal extent.

**data quality subelement**

component of a data quality element describing a certain aspect of that data quality element [ISO 19113]

**data quality value type**

value type for reporting a data quality result [ISO 19113]

EXAMPLE "boolean variable", "percentage", "ratio"

NOTE A data quality value type is always provided for a data quality result.

**data quality value unit**

value unit for reporting a data quality result [ISO 19113]

EXAMPLE "metre"

NOTE A data quality value unit is provided only when applicable for a data quality result.

**data type**

specification of a value domain with operations allowed on values in this domain [ISO/TS 19103:2005]

EXAMPLE Integer, Real, Boolean, String, DirectPosition and Date

NOTE Data types include primitive predefined types and user-definable types.

NOTE A data type is identified by a term, e.g. Integer

**dataset**

identifiable collection of data [ISO 19115]

NOTE A dataset may be a smaller grouping of data which, though limited by some constraint such as spatial extent or feature type, is located physically within a larger dataset. Theoretically, a dataset may be as small as a single feature or feature attribute contained within a larger dataset. A hardcopy map or chart may be considered a dataset.

**dataset series**

collection of datasets sharing the same product specification [ISO 19115:2003]

**datum**

parameter or set of parameters that define the position of the origin, the scale, and the orientation of a coordinate system [ISO 19113]

**dependency**

relationship between two modelling elements, in which a change to one modelling element (the independent element) will affect the other modelling element (the dependent element)

**direct position**

position described by a single set of coordinates within a coordinate reference system [ISO 19107]

**discrete coverage**

coverage that returns the same feature attribute values for every direct position within any single geometric object in its spatiotemporal domain [ISO 19123]

NOTE The spatiotemporal domain of a discrete coverage consists of a finite set of geometric objects.

**domain**

well-defined set [ISO/TS 19103:2005]

NOTE Domains are used to define the domain set and range set of attributes, operators and functions.

**ellipsoid**

surface formed by the rotation of an ellipse about a main axis [ISO 19111]

Mathematically it is expressed in Cartesian coordinates as:  $\frac{x^2+y^2}{a^2} + \frac{z^2}{b^2} = 1$

Where 'a' is the semi-major axis and 'b' is the semi-minor axis. The latter is the rotation axis, such ellipsoids are also called oblate spheroids.

**ellipsoidal coordinate system**

coordinate system in which position is specified by geodetic latitude, geodetic longitude and (in the three dimensional case) ellipsoidal height [ISO 19111]

**ellipsoidal height**

distance of a point from the ellipsoid measured along the perpendicular from the ellipsoid to this point; positive if upwards or outside of the ellipsoid [ISO 19111]

**encoding**

Conversion of data into a series of codes [ISO 19118]

**end point**

last point of a curve [ISO 19107]

**event**

action which occurs at an instant [ISO 19108:2002]

**exterior**

difference between the universe and the closure [ISO 19107]

NOTE The concept of exterior is applicable to both topological and geometric complexes.

**face**

2-dimensional topological primitive [ISO 19107]

NOTE The geometric realization of a face is a surface. The boundary of a face is the set of directed edges within the same topological complex that are associated to the face via the boundary relations. These can be organized as rings

**feature**

Abstraction of real world phenomena [ISO 19101:2003]

NOTE A feature may occur as a type or an instance. Feature type or feature instance should be used when only one is meant.

EXAMPLE The phenomenon named 'Eiffel Tower' may be classified with other phenomena into a feature type 'tower'.

**feature association**

relationship that links instances of one feature type with instances of the same or a different feature type [ISO 19110]

**feature attribute**

characteristic of a feature [ISO 19101]

NOTE A feature attribute type has a name, a data type and a domain associated to it. A feature attribute instance has an attribute value taken from the value domain of the feature attribute type.

EXAMPLE 1 A feature attribute named 'colour' may have an attribute value 'green' which belongs to the data type 'text'.

EXAMPLE 2 A feature attribute named 'length' may have an attribute value '82,4' which belongs to the data type 'real'.

**feature catalogue**

A catalogue containing definitions and descriptions of the feature types, feature attributes, and feature associations occurring in one or more sets of geographic data [ISO 19110]

**feature portrayal function**

function that maps a geographic feature to a **symbol**

[ISO 19117:2012 (E), 4.10]

**field**

A named collection of labeled *subfield(s)*. For example, IHO attribute label/code and IHO Attribute Value are collected into a field named Feature Record Attribute.

**flattening**

ratio of the difference between the semi-major (*a*) and semi-minor axis (*b*) of an ellipsoid to the semi-

major axis  $f = \frac{a-b}{a}$  [ISO 19111]

**function**

rule that associates each element from a domain (source, or domain of the function) to a unique element in another domain (target, co-domain, or range) [ISO 19107]

NOTE The range is defined by another domain.

**generalization**

taxonomic relationship between a more general element and a more specific element [ISO 19103]

NOTE The more specific element is fully consistent with the more general element and contains additional information. An instance of the more specific element may be used where the more general element is allowed. See: inheritance.

**geodetic coordinate reference system**

coordinate reference system based on a geodetic datum [ISO 19111]

**geodetic datum**

datum describing the relationship of a 2- or 3-dimensional coordinate system to the Earth [ISO 19111]

**geodetic latitude**

angle from the equatorial plane to the perpendicular to the ellipsoid through a given point, northwards treated as positive [ISO 19111]

**geodetic longitude**

angle from the prime meridian plane to the meridian plane of a given point, eastward treated as positive [ISO 19111]

**geographic information**

Information concerning phenomena implicitly or explicitly associated with a location relative to the Earth [ISO 19101:2003]

**geolocation information**

information used to determine geographic location corresponding to image location

**geometric aggregate**

collection of geometric objects that has no internal structure [ISO 191107]

**geometric boundary**

boundary represented by a set of geometric primitives of smaller geometric dimension that limits the extent of a geometric object [ISO 19107]

**geometric complex**

set of disjoint geometric primitives where the boundary of each geometric primitive can be represented as the union of other geometric primitives of smaller dimension within the same set [ISO 19107]

NOTE The geometric primitives in the set are disjoint in the sense that no direct position is interior to more than one geometric primitive. The set is closed under boundary operations, meaning that for each element in the geometric complex, there is a collection (also a geometric complex) of geometric primitives that represents the boundary of that element. Recall that the boundary of a point (the only 0D primitive object type in geometry) is empty. Thus, if the largest dimension geometric primitive is a surface (2-D), the composition of the boundary operator in this definition terminates after at most two steps. It is also the case that the boundary of any object is a cycle.

**geometric dimension**

largest number *n* such that each direct position in a geometric set can be associated with a subset

that has the direct position in its interior and is similar (isomorphic) to  $R_n$ , Euclidean n-space [ISO 19107]

**geometric object**

spatial object representing a set of direct positions [ISO 19107]

NOTE A geometric object consists of a geometric primitive, a collection of geometric primitives, or a geometric complex treated as a single entity. A geometric object may be the spatial characteristics of an object such as a feature or a significant part of a feature

**geometric primitive**

geometric object representing a single, connected, homogeneous element of geometry [ISO 19107]

NOTE Geometric primitives are non-decomposed objects that present information about geometric configuration. They include points, curves, surfaces, and solids.

**geometry value object**

object composed of a set of geometry value pairs such that the geometric object elements of the geometry value pairs are elements of a larger geometric object [ISO 19123]

**georectified**

corrected for positional displacement with respect to the surface of the earth

**georeferencing**

process of determining the relation between the position of data in the image coordinates and its geographic or map location

**grid**

network composed of two or more sets of curves in which the members of each set intersect the members of the other sets in an algorithmic way [ISO 19123:2005]

NOTE The curves partition a space into grid cells.

**grid coordinate system**

coordinate system in which position is specified relative to the intersection of curves

**grid coordinates**

sequence of two or more numbers specifying a position with respect to its location on a grid

**grid point**

point located at the intersection of two or more curves in a grid [ISO 19123]

**gridded data**

data whose attribute values are associated with positions on a grid coordinate system

**ground control point**

point on the earth that has an accurately known geographic position

**human readable**

A representation of information that can be naturally read by humans

**identifier**

A linguistically independent sequence of characters capable of uniquely and permanently identifying that with which it is associated [adapted from ISO/IEC 11179-3:2003]

**image**

gridded coverage whose attribute values are a numerical representation of a physical parameter

NOTE The physical parameters are the result of measurement by a sensor or a prediction from a model.

**image coordinate reference system**

coordinate reference system based on an image datum

**image datum**

datum which defines the relationship of a coordinate system to an image

**imagery**

representation of phenomena as images produced by electronic and/or optical techniques [ISO 19101-2:2008]

NOTE In this part of ISO 19115, it is assumed that the objects and phenomena have been sensed or detected by camera, infrared and multispectral scanners, radar and photometers, or other remote sensing instruments and devices.

**inheritance**

mechanism by which more specific elements incorporate structure and behaviour of more general elements related by behaviour [ISO 19103]

NOTE See generalization.

**instance**

entity to which a set of operations can be applied and which has a state that stores the effects of the operations [ISO 19103]

NOTE See: object.

**interior**

set of all direct positions that are on a geometric object but which are not on its boundary [ISO 19107]

NOTE The interior of a topological object is the homomorphic image of the interior of any of its geometric realizations. This is not included as a definition because it follows from a theorem of topology.

**ISO/IEC 8211 record**

An ISO/IEC 8211 implementation of a S-57 *record* and which comprises one or more *fields*.  
label

An ISO/IEC 8211 implementation concept used to identify the *subfield*.

**machine readable**

A representation of information that can be processed by computers

**map projection**

coordinate conversion from an ellipsoidal coordinate system to a plane [ISO 19111]

**meridian**

intersection of an ellipsoid by a plane containing the shortest axis of the ellipsoid [ISO 19111]

**metadata**

data about data [ISO 19115:2005]

**metadata element**

Discrete unit of metadata

NOTE Metadata elements are unique within a metadata entity.

NOTE Equivalent to an attribute in UML terminology.[ISO 19115:2005]

**metadata entity**

set of metadata elements describing the same aspect of data

NOTE May contain one or more metadata entities.

NOTE Equivalent to a class in UML terminology. [ISO 19115:2005]

**metadata section**

subset of metadata which consists of a collection of related metadata entities and metadata elements

NOTE Equivalent to a package in UML terminology. [ISO 19115:2005]

**metamodel**

model that defines the language for expressing a model

**model**

abstraction of some aspects of universe of discourse [ISO 19101]

NOTE A semantically complete abstraction of a system

**modification**

a substantive semantic change to a register item [ISO 19135]



**multiplicity**

specification of the number of possible occurrences of a property, or the number of allowable elements that may participate in a given relationship [ISO 19103].

EXAMPLES 1..\* (one to many) , 1 (exactly one), 0..1 (zero or one).

**object**

entity with a well-defined boundary and identity that encapsulates state and behaviour

NOTE State is represented by attributes and relationships, behaviour is represented by operations, methods, and state machines. An object is an instance of a class. See: class, instance.

**package**

general purpose mechanism for organizing elements into groups [ISO 19103]

NOTE Packages may be nested within other packages. Both model elements and diagrams may appear in a package.

**pass**

single instance of a remote, mobile measuring system going by a target of interest

NOTE In this part of ISO 19115, the measuring system will usually be a remote sensing platform. In a navigation context, the measuring system might be a GPS satellite.

**pixel**

smallest element of a digital image to which attributes are assigned [ISO 19129]

NOTE It is the smallest unit of display for a visible image.

**platform**

structure which supports a sensor, or sensors

**point**

0-dimensional geometric primitive, representing a position [ISO 19107]

NOTE The boundary of a point is the empty set.

**point coverage**

coverage that has a spatial domain composed of points [ISO 19123]

**polarisation**

restricting radiation, especially light, vibrations to a single plane

**portrayal**

Presentation of information to humans [ISO 19117]

NOTE Within the scope of this International Standard portrayal is restricted to the portrayal of geographic information.

**portrayal catalogue**

collection of defined **portrayals** for a feature catalogue

NOTE Content of a portrayal catalogue includes **portrayal functions**, **symbols**, and **portrayal context**.

[ISO 19117:2012 (E), 4.21]

**portrayal context**

circumstances, imposed by factors extrinsic to a geographic dataset, that affect the **portrayal** of that dataset

NOTE Portrayal context can influence the selection of **portrayal functions** and construction of **symbols**.

EXAMPLE Factors contributing to portrayal context can include the proposed display or map scale, the viewing conditions (day/night/dusk), and the display orientation requirements (north not necessarily at the top of the screen or page) among others.

[ISO 19117:2012 (E), 4.22]

**portrayal function**

function that maps geographic features to **symbols**

NOTE **Portrayal** functions can also include parameters and other computations that are not dependent on geographic feature properties.

[ISO 19117:2012 (E), 4.23]

**portrayal rule**

specific type of **portrayal function** expressed in a declarative language

NOTE A declarative language is rule-based and includes decision and branching statements.

[ISO 19117:2012 (E), 4.25]

**pre-order Traversal Sequence**

Representation of the order in which information, in a tree structure diagram, must be interpreted. The sequence is extremely important and inviolate as there is no other explicit method of specifying the interfield (parent/child) relationships within the ISO/IEC 8211 data records.

**prime meridian**

meridian from which the longitudes of other meridians are quantified [ISO 19111]

**profile**

set of one or more base standards or subsets of base standards, and, where applicable, the identification of chosen clauses, classes, options and parameters of those base standards, that are necessary for accomplishing a particular function.

NOTE A profile is derived from base standards so that by definition, conformance to a profile is conformance to the base standards from which it is derived. [ISO 19106:2005]

**projected coordinate reference system**

coordinate reference system derived from a two-dimensional geodetic coordinate reference system by applying a map projection [ISO 19111]

**quadtree**

expression of a two-dimensional object as a tree structure of quadrants, which are formed by recursively subdividing each non-homogeneous quadrant until all quadrants are homogeneous with respect to a selected characteristic, or until a predetermined cut-off depth is reached [ISO 2382]

**quality**

totality of characteristics of a product that bear on its ability to satisfy stated and implied needs [ISO 19113]

**range <coverage>**

set of values associated by a function with the elements of the spatiotemporal domain of a coverage [ISO 19123]

**raster**

usually rectangular pattern of parallel scanning lines forming or corresponding to the display on a cathode ray tube [ISO 19123]

NOTE A raster is a type of grid.

**realization**

relationship between a specification and its implementation [ISO 19103]

NOTE An indication of the inheritance of behaviour without the inheritance of structure.

**record**

finite, named collection of related items (objects or values) [ISO 19107]

NOTE Logically, a record is a set of pairs <name, item >.

**rectified grid**

grid for which there is a linear relationship between the grid coordinates and the coordinates of an

external coordinate reference system [ISO 19123]

NOTE If the coordinate reference system is related to the earth by a datum, the grid is a georectified grid.

**referenceable grid**

grid associated with a transformation that can be used to convert grid coordinate values to values of coordinates referenced to an external coordinate reference system [ISO 19123]

NOTE If the coordinate reference system is related to the earth by a datum, the grid is a georeferenceable grid.

**register**

set of files containing identifiers assigned to items with descriptions of the associated items [ISO 19135]

NOTE Descriptions may consist of many types of information, including names, definitions and codes.

**register manager**

organization to which management of a register has been delegated by the register owner [ISO 19135]

NOTE In the case of an IHO register, the register manager performs the functions of the registration authority specified in the IHO Directives.

**register owner**

organization that establishes a register [ISO 19135]

**registration**

assignment of a permanent, unique (in the register), and unambiguous identifier to an item [ISO 19135]

**registry**

information system on which a register is maintained [ISO 19135]

**relationship**

semantic connection among model elements [ISO 19103]

NOTE Kinds of relationships include association, generalization, metarelationship, flow, and several kinds grouped under dependency.

**remote sensing**

collection and interpretation of information about an object without being in physical contact with the object

**render**

conversion of digital graphics data into visual form [ISO 19117]

EXAMPLE Generation of an image on a video display.

**resolution (of a sensor)**

smallest difference between indications of a sensor that can be meaningfully distinguished

NOTE For imagery, resolution refers to radiometric, spectral, spatial and temporal resolutions. [ISO/TS 19101-2:2008]

**resource**

asset or means that fulfils a requirement

EXAMPLE Dataset, service, document, person or organisation. [ISO 19115:2005]

**retirement**

declaration that a register item is no longer suitable for use in the production of new data [ISO 19135]

NOTE The status of the retired item changes from 'valid' to 'retired'. A retired item is kept in the register to support the interpretation of data produced before its retirement.

**ring**

simple curve which is a cycle [ISO 19107]

NOTE Rings are used to describe boundary components of surfaces in 2-D coordinate systems.

**schema**

formal description of a model [ISO 19101]

**semi-major axis**

semi-diameter of the longest axis of an ellipsoid [ISO 19111]

**semi-minor axis**

semi-diameter of the shortest axis of an ellipsoid [ISO 19111]

**sensor**

element of a measuring instrument or measuring chain that is directly affected by the measurand [International Vocabulary of Basic and General Terms in Metrology (VIM)]

**sensor model**

description of the radiometric and geometric characteristics of a sensor [ISO19101-2:2008]

**spatial reference**

description of position in the real world

**spatiotemporal domain <coverage>**

domain composed of geometric objects described in terms of spatial and/or temporal coordinates [ISO 19123]

NOTE The spatiotemporal domain of a continuous coverage consists of a set of direct positions defined in relation to a collection of geometric objects.

**specification**

declarative description of what something is or does

NOTE Contrast: implementation.

**specification scope**

A partitioning of the data content of the product on the basis of one or more criteria [adapted from ISO 19131]

**spectral resolution**

specific wavelength interval within the electromagnetic spectrum

EXAMPLE Band 1 of Landsat TM lies between 0.45 and 0.52  $\mu\text{m}$  in the visible part of the spectrum.

**start point**

first point of a curve [ISO 19107]

**stereotype**

new type of modelling element that extends the semantics of the metamodel [ISO 19103]

NOTE Stereotypes must be based on certain existing types or classes in the metamodel.

Stereotypes may extend the semantics, but not the structure of pre-existing types and classes.

Certain stereotypes are predefined in the UML, others may be user defined. Stereotypes are one of three extensibility mechanisms in UML. The others are constraint and tagged value.

**subfield**

A subfield is a component of a *field*. It is a contiguous string of bytes whose position, length and data type are described in the field data description. It is the smallest unit of information which can be described by this standard.

NOTE Certain stylized subfields, such as date (YYYYMMDD), must be further resolved by an application.

**submitting organization**

organization authorised by a register owner to propose changes to the content of a register [ISO 19135]

**subregion**

collection of geospatial data for a specific area within a dataset where the geospatial data conforms to a common, specific acquisition requirement that may differ from that of other collections within the cell

**supersession**

replacement of a register item by one or more new items [ISO 19135]

NOTE The status of the replaced item changes from 'valid' to 'superseded.' A superseded item is kept in the register to support the interpretation of data produced before its supersession.

**surface**

connected 2-dimensional geometric primitive, representing the continuous image of a region of a plane [ISO 19107]

NOTE The boundary of a surface is the set of oriented, closed curves that delineate the limits of the surface.

**surface patch**

2-dimensional, connected geometric object used to represent a continuous portion of a surface using homogeneous interpolation and definition methods [ISO 19107]

**symbol**

Portrayal primitive such as linestyles, patterns, text and point symbol graphics defined in SVG

**tag**

An ISO/IEC 8211 implementation concept used to identify each instance of a *field*.

**tag value**

explicit definition of a property as a name-value pair

NOTE In a tagged value, the name is referred as the tag. Certain tags are predefined in the UML; others may be user defined. Tagged values are one of three extensibility mechanisms in UML. The others are constraint and stereotype.

**temporal reference system**

reference system against which time is measured

**tessellation**

partitioning of a space into a set of conterminous geometric objects having the same dimension as the space being partitioned [ISO 19123]

NOTE A tessellation composed of congruent regular polygons or polyhedra is a regular tessellation; One composed of regular, but non-congruent polygons or polyhedra is semi-regular. Otherwise the tessellation is irregular.

**triangulated irregular network (TIN)**

tessellation composed of triangles [ISO 19123]

**tuple**

ordered list of values

**type**

stereotype of class that is used to specify a domain of instances (objects) together with the operations applicable to the objects

NOTE A type may have attributes and associations.

**unit**

defined quantity in which dimensioned parameters are expressed

**value**

element of a type domain [ISO/TS 19103:2005]

NOTE 1 A value may be considered a possible state of an object within a class or type (domain).

NOTE 2 A data value is an instance of a data type, a value without identity.

**value domain**

set of accepted values [ISO/TS 19103:2005]

EXAMPLE The range 3-28, all integers, any ASCII character, enumeration of all accepted values (green, blue, white).

**vertical coordinate reference system**

one-dimensional coordinate reference system based on a vertical datum [ISO 19111]

**vertical coordinate system**

one-dimensional coordinate system used for gravity-related height or depth measurements [ISO 19111]

**vertical datum**

datum describing the relation of gravity-related heights or depths to the Earth [ISO 19111]