



Unique Maritime Group
Strength in Depth

Regional Hydrographic Research, Studies & Projects

– Support from Unique Maritime Group

A. Sharad Kumar

Regional Manager - UMG

6th March 2013





1. Introduction to UMG
2. Group Competencies and Divisions
3. Survey Equipments
4. Projects
5. Support





UMG Introduction

- Unique Maritime Group is a global provider of integrated support services for the Marine and offshore industries.
- Founded in 1993, over 20 years experience in specialist fields across a wide spectrum of industries including marine, offshore construction, hydrographic survey, environmental, non-destructive testing, diving, Specialized Engineering Services etc
- The Group's capabilities also extend to specific industries such as pipeline petrochemical, construction, shipyards and hydrographic departments.





Unique Maritime Group
Strength in Depth

UMG Group companies

- **Unique System FZE / Unique System L.L.C (UAE)**
- **Unique System (UK) Ltd**
- **Unique System L.L.C (USA)**
- **Unique Hydra (Pty) Ltd (South Africa)**
- **Unique Wellube FZC (UAE)**
- **Unique Computer Systems FZE/L.L.C (UAE)**
- **Seaflex Ltd. (UK)**
- **Unique Hydrographic System Pvt. Ltd. (India)**
- **Unique System Russia LLC**
- **Unique Wellube Qatar**
- **Unique Nigeria**

Joint Ventures

Kongsberg Maritime Middle East DMCC, Dubai

Compass Petroleum Services, Abudhabi

Sea and Land Technologies – Singapore

Unique Tile Services – Oman

Unique Marorka Support Services - UAE



Unique System FZE
A Unique Maritime Group Company



Base facility

- Hamriyah Free Zone facility , UAE
- Our modern facility in Hamriyah Free Zone, Sharjah - UAE,
- Combines corporate & administration offices, electronic & mechanical workshop facilities, training facilities, warehouse
- Facilities together with a 15,000 sq. meters of available yard space.





Base facility



Repair and Maintenance Facility



Underwater Cable Splicing



Training Centre





UMG Divisions

- Marine Solutions
- Survey Solutions
- Diving Solutions
- Rental Solutions
- Inspection Division
- Buoyancy Products
- Specialized Engineering
- OSR and Waste Oil Treatment
- Specialized Security Solutions
- Training
- Customer Support Division

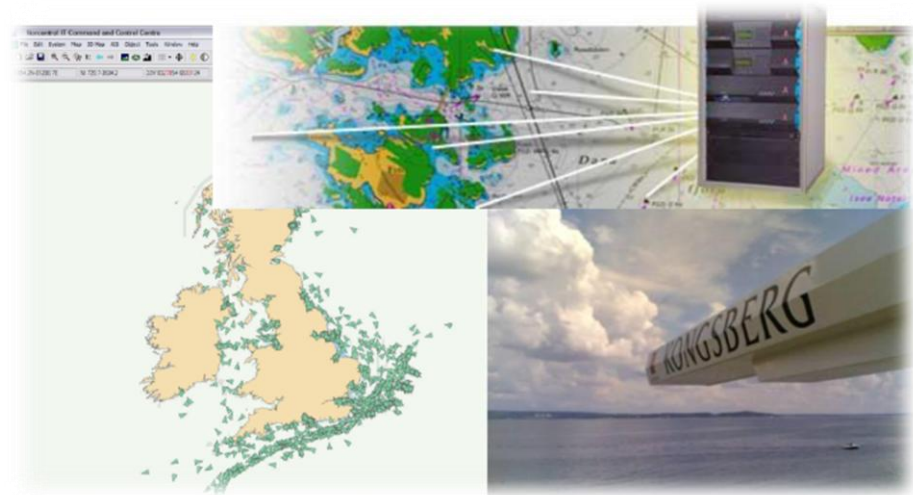

Our Competencies



Unique Maritime Group
Strength in Depth

- Decades of experience in Marine, Industrial and Offshore services
- Specialized Engineering services
- Engineering background in Communication, Instrumentation, Marine, Mechanical, Navigation, Electrical, Automation, Software and Industrial Electronics
- Turn key Installation and Commissioning Projects
- Annual Maintenance Contract for Global support
- Project Design, handling and implementation
- Own Manufacturing facilities



Unique System FZE
A Unique Maritime Group Company

IMS Certifications



Unique Maritime Group
Strength in Depth



Unique System FZE
A Unique Maritime Group Company

Appreciations



Unique Maritime Group
Strength in Depth

SHARJAH
**Economic
Excellence Award**
LOCAL AWARD GLOBAL QUALITY



جائزة
الإشراقية
للتميز الاقتصادي



CERTIFICATE

Sharjah Economic Excellence Award
(SEEA) Board of Trustees has awarded

Unique Maritime Group FZC

Sharjah Economic Excellence Award for the
year 2010 - Large Firms Category -
Service Sector for completing the
requirements of the award and excelling in
implementing its criteria.

Date: 18/05/2011

أحمد محمد الحداد
Ahmad Mohamed Al Hada
رئيس غرفة تجارة وصناعة الشارقة
Chairman of Sharjah Chamber of Commerce & Industry
رئيس مجلس أمناء الجائزة
Chairman of the Board of Trustees of SEEA

غرفة تجارة وصناعة الشارقة
Sharjah Chamber of Commerce & Industry

شهادة

فاز مجلس أمناء جائزة الشارقة
للتميز الاقتصادي منح

مجموعة الملاحة الفريدة ش م ح

جائزة الشارقة للتميز الاقتصادي عن
العام 2010 - فئة المنشآت الكبيرة -
القطاعخدمي وذلك لإستكمالها كافة
متطلبات الجائزة وتبنيها في تطبيق جميع
معاييرها.

التاريخ: 2011/05/18



شكر وتقدير
CERTIFICATE OF APPRECIATION



يسر بلدية دبي منح هذه الشهادة إلى
Dubai Municipality is delighted to award

Unique System FZE Company

In recognition of your fruitful efforts and constant
cooperation for maximum utilization of all available
possibilities to support the municipal services and
activities.

تقديرًا لجهودها المثمرة وعرفاناً منا لتعاونها الدائم في
تسخير كافة الإمكانيات المتوفرة لدعم مسار العمل
لدى الدائرة

Wishing you every success

22 March 2012



Eng. Hussain Nasser Lootah
Director General, Dubai Municipality

مع تمنياتنا لكم بدوام التوفيق والنجاح

22 مارس 2012

م. حسين ناصر لوتاه
مدير عام بلدية دبي

Winner of 2010 Sharjah
Economic Excellence Award
Unique System FZE

A Unique Maritime Group Company



Dubai Municipality - 2012
Contractor Appreciation



Survey division

- Leading provider of survey equipment rental and sales, offering some of the latest technology available from the world's leading manufacturers.
- We specialize in survey software solutions, magnetometers, positioning solutions, gyros and motion sensors, sonar solutions, environmental measurements and underwater NDT and video inspection.
- Our team of experienced engineers can assist with the installation, set-up, calibration, maintenance and training to support our extensive inventory of equipment.





Survey Equipments

- Hydrographic Systems
 - Single beam Echo sounders
 - Multibeam Echo sounders
 - Swath Bathymetric System
 - Hydrographic Software's
 - Charting Software's

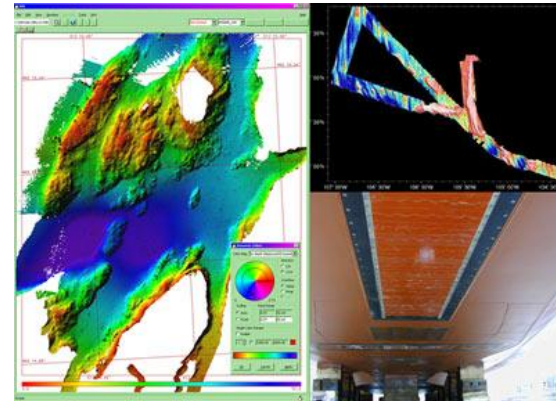

KONGSBERG



Unique System FZE
A Unique Maritime Group Company

caris



HYPACK, Inc.
<http://www.hypack.com>



Survey Equipments

Survey Positioning & Navigation Systems

- DGPS surface positioning systems
- RTK surface positioning systems
- USBL Underwater positioning systems
- LBL Underwater positioning systems
- Gyrocompasses
- Heave & Motion Sensors
- Inertial Navigational System

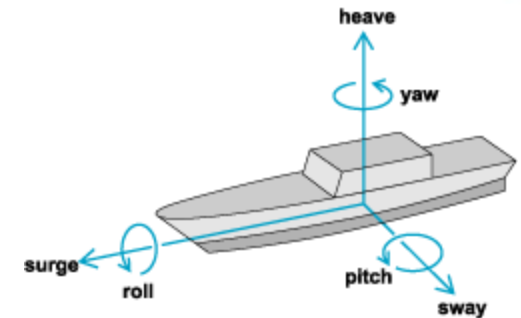



Survey Equipments

Environmental & Oceanographic Measurement systems

- ADCP
- Automatic Weather Stations
- CTD
- Current Meters
- SVP
- Tide Gauges
- Water samplers
- Water Quality Sensors
- Wave Measurement System





Survey Equipments

Geophysical & Geotechnical Systems

- Side Scan Sonars
- Sub Bottom Profilers
- Sparker & Boomer system
- Sonar & Seismic data acquisition & processing system
- Magnetometers
- Seabed grabs & coring system
- Winches & cables





Survey Equipments

AUV , ROV systems & payloads

- AUV
- ROV - Observation & Inspection class
- ROV work skids, tools & manipulator
- ROV HPU's & pumps
- Obstacle & Imaging Sonars
- 3D Sonars
- Altimeters & Depth sensors
- Pipe trackers
- Underwater cameras & lights
- Diver Detection and Intervention



HYDROID
A KONGSBERG COMPANY

Seabeam

Tritech





Turnkey solution

- Turnkey solution for survey equipment packages
 - Turnkey project scope includes design, supply, installation, commissioning, trials and on-site support services.
 - Customized training courses on survey equipment configuration, operation & maintenance – classroom, workshop & field training
 - Team of experienced project managers, engineers who could execute & support various projects.
 - On-site support towards system calibration, maintenance & warranty services.





Project references

General Commission for Survey, KSA – Survey Launch

- Hydrographic Survey Launch with equipments for Hydrographic, Geophysical Surveys, Geotechnical & Oceanographic surveys with accommodation for 11 personnel.
- 16 m catamaran platform with medium water multibeam & single beam echosounder, side scan sonar, towed sub bottom profiler, ADCP, water quality profiling system with integrated water sampler rosette, magnetometer, grab sampler, seabed corer, scuba replacement package.
- Deck gear including A-frame, tow winch, free fall winch, RIB with OBM, davits, 1 ton boom crane.





Project references

GHQ UAE Armed Forces – Hydrographic Survey Packages

- Kongsberg EM3002 Multibeam & EA400 single beam echosounder packages for 3 vessels in operation since 2007
- Turnkey project scope includes design, supply, installation, commissioning, trials and on-site support services.
- Recently contracted for commissioning 2 new vessels with the latest EM2040 Dual receiver wideband multibeam system and 5 vessels with EA 400 single beam echosounder systems





Project references

Dubai Municipality – Weather Forecasting System

- Weather Forecasting system in operation since 2010
- Integrated monitoring stations includes offshore buoy, terrestrial & coastal stations .

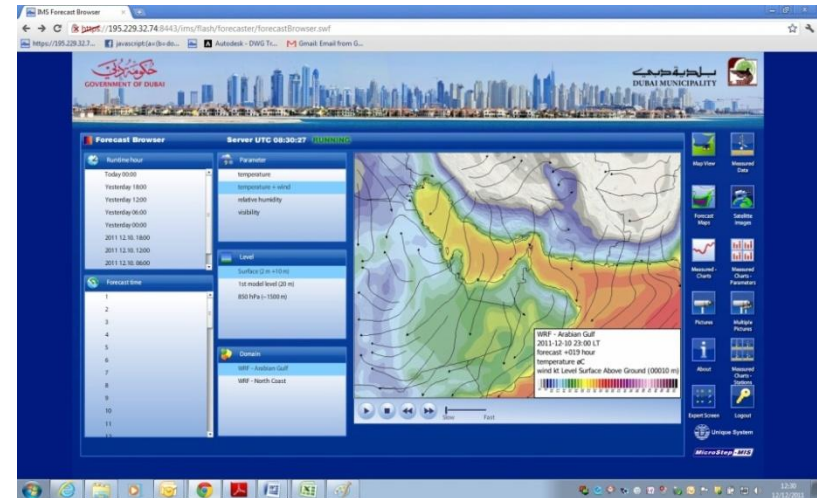



Project references

Dubai Municipality – Tide Gauge Network

- Operation & maintenance support services for coastal tide-met stations.
- Tide-met stations in operation since 2004 and upgraded in 2011 with latest data logging & transmission
- In 2012 commissioned a permanent tide gauge station compliant with GLOSS standard





Project references

E-Marine, UAE – Containerized Survey System

- Integrated System for Hydrographic, Geophysical Surveys & Oceanographic for supporting E-Marine cable lay operations.
- Containerized solution for portability between E-Marine survey & cable lay vessels.
- Dedicated consoles for data acquisition & post processing





Project references

King Abdulaziz Univ., KSA – Hydrographic training vessel package

- Integrated System for Hydrographic & Geophysical Surveys for supporting university survey training requirement.
- Package including multibeam & single beam echosounder, side scan sonar, towed sub bottom profiler, ROV with onshore post processing facility at the university.





Project references

King Abdulla University of Science & Technology , KSA – AUV

- Supply, training & deployment support on Kongsberg Hydroid REMUS 100 Autonomous Underwater Vehicle (AUV)
- AUV platform including ADCP, CTD, Side scan sonar and GPS.
- Integrated INS for precise navigation.
- LBL package for navigation with acoustic transponders.





Project references

General Commission for Survey, KSA – Tide Gauge Network

- Integrated Tide-met monitoring network with 7 stations along Red Sea & 5 stations on Arabic Gulf
- Centralized data collection, quality control, statistical analysis and data base management at GCS HO at Riyadh.
- Development of customized GCSTide software for tidal data analysis and modeling

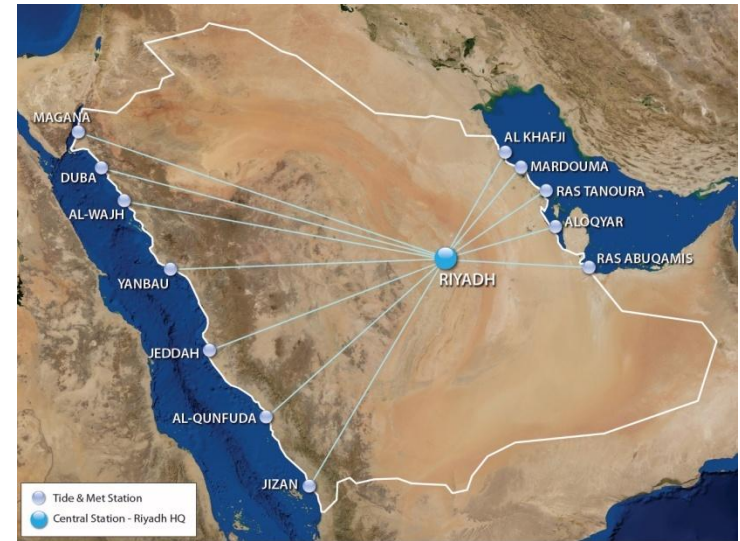



Project references

NMDC, UAE – 3D sonar for offshore construction support

- Supply, installation, commissioning & training support on 3 nos. Coda Echoscope 3D sonar systems for offshore construction support.
- Customized software for reconnaissance and tracking of acropodes & X-blocks.

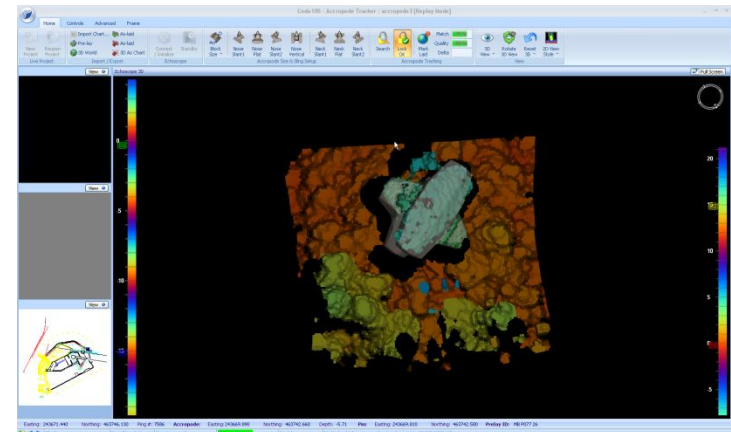
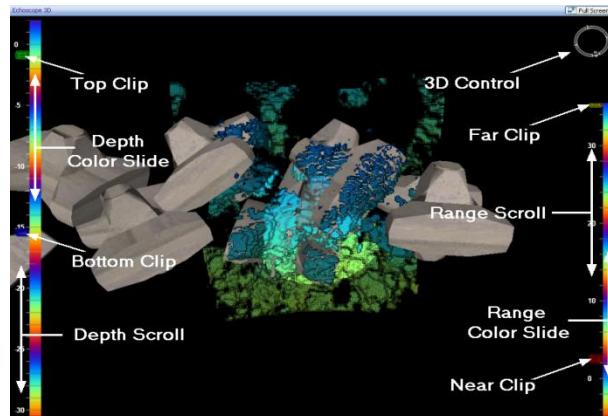



Project references

NPCC, UAE – Hydrographic & Geophysical survey packages

- Supply & training support on hydrographic & geophysical survey packages like Kongsberg EM 3002 Multibeam Echosounders, Coda DA2000 GeoSurvey sonar & seismic acquisition & post processing system , GeoAcoustics side scan sonars and sub bottom profiler systems





Project references

Port of Aden, Yemen - Hydrographic survey vessel package

- Supply, commissioning & training support on hydrographic survey packages including Kongsberg EM 3002 Multibeam Echosounder, Seapath 200 RTK, EA400 single beam echosounder, Geo Acoustic sub bottom profiler, SeaSpy magnetometer, on Port of Aden new survey vessel in 2011.
- Hypack software for data collection & post processing.





Project references

QP, Qatar –Data Buoy for Massaied Port

- Supply, commissioning & training support on offshore data buoy for port safety and early warning application at Massaied port
- Offshore buoy for measurement of wind speed & direction, air temperature, air pressure, relative humidity, water current water temperature and wave.
- Real-time data transmission to port office by radio link with satellite as back-up.





Project references

UPDS, Qatar – Hydrographic & Geophysical survey packages

- Supply, commissioning & training support on hydrographic survey packages including Kongsberg EM 3002D Multibeam Echosounder, Seapath 200 RTK, EA400 single beam echosounder on UPDS hydrographic vessel Al Massah in 2010.
- Hypack software for data collection.
- Caris HIPS SIPS for post processing





Project references

ZADCO, UAE – Metocean monitoring package for Zirku Island

- Design, Supply & Installation of Met-Ocean monitoring stations at Zirku Island facilities including OSR platform, jetty and airport.
- Centralised station for data collection & processing with Oracle platform for database management.

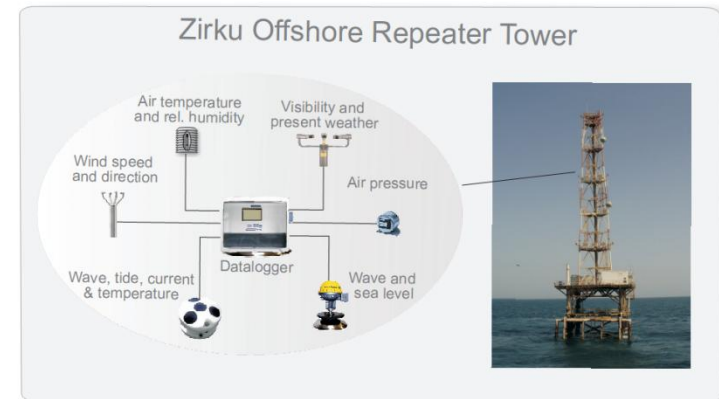

Competency Development



Unique Maritime Group
Strength in Depth

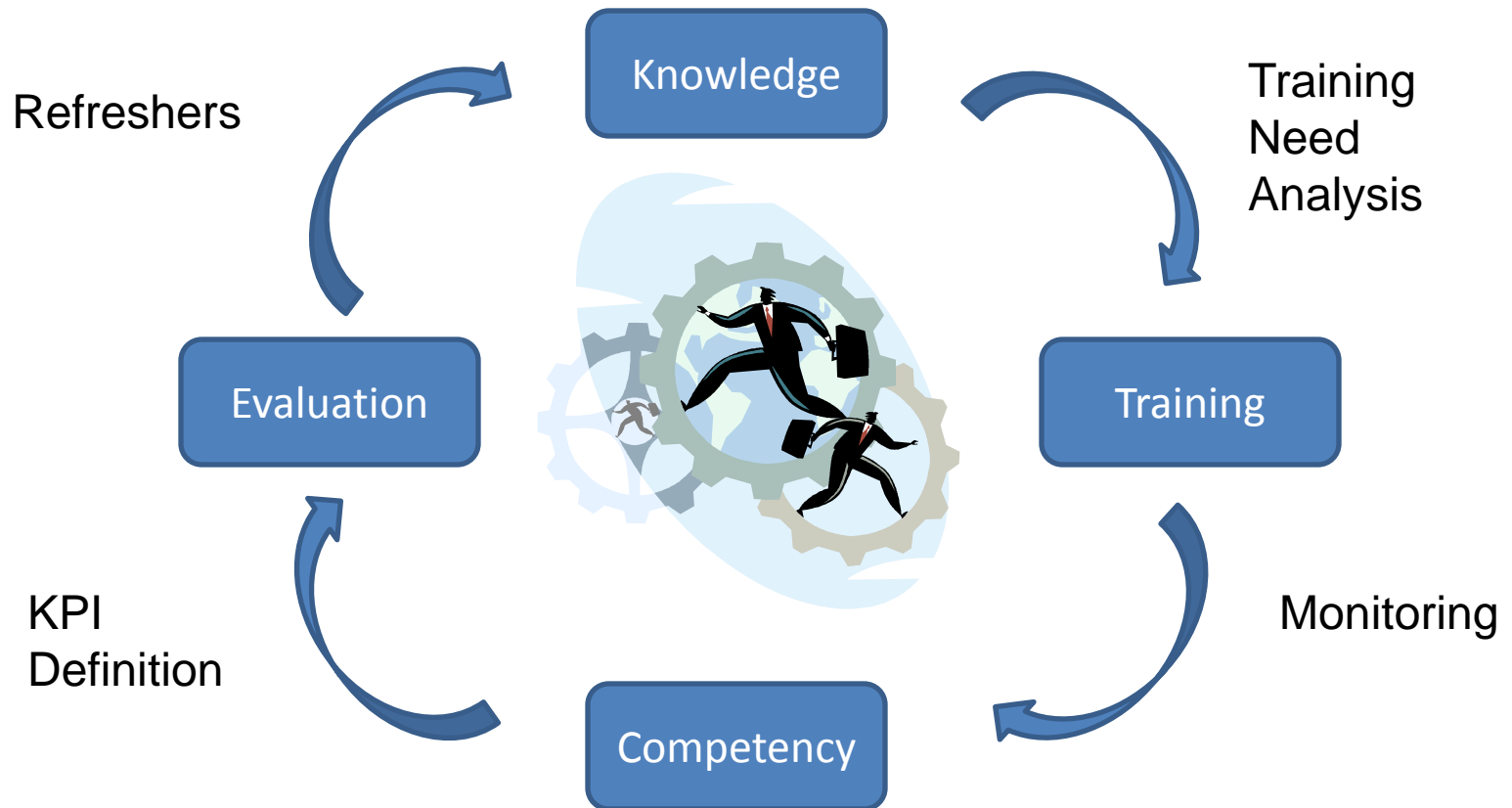

Unique System FZE
A Unique Maritime Group Company



Support

- Continuous User interaction
- Periodic User Conferences, Seminars, Workshops
- Kongsberg Maritime Solutions and Hypack – recent seminars
- Training Package for clients
- Competency based Training
- Identifying KPI and ROI on Training
- Project assistance
- Newsletters
- Integrated packaged solutions
- University attachment programs
- Simulator Training – First DP / ROV Training centers in Middle East and Africa





Unique Maritime Group
Strength in Depth

...together for a better world.

Thank you.



Unique System FZE
A Unique Maritime Group Company